



Munich Personal RePEc Archive

The effect of vertical knowledge spillovers via the supply chain on location decision of firms

Kashefi, Mohammad Ali

Bielefeld Graduate School of Economics and Management (BiGSEM), Germany

1 May 2011

Online at <https://mpra.ub.uni-muenchen.de/45873/>
MPRA Paper No. 45873, posted 05 Apr 2013 15:32 UTC

The Effect of Vertical Knowledge Spillovers via the Supply Chain on Location Decision of Firms

Mohammad Ali Kashefi [†]

In this paper a game theoretic model is employed to analyze the relationship between strategic location decision of firms in the supply chain considering the role of horizontal and vertical knowledge spillovers, and numerical approach is applied to characterize the equilibria of the considered multi-stage game. Geographical concentration or isolation as equilibrium outcome is determined based on our different parameterizations and two scenarios each consists of two separated cases, which we establish according to the location of our agents. In the first scenario both suppliers are supposed to be located in different regions while in the second one they act in a same region. In addition, first case of each scenario considers geographical isolation of two producers whereas second case investigates the geographical concentration. Furthermore, the effect of different technological level of our agents on their final location decision is investigated.

JEL Classification: C61, C72, C88, D83, L13, R30

Keywords: Strategic Firm Location, Knowledge Spillover, Geographical Concentration, Supply Chain

1. Introduction

“Everything is related to everything else, but near things are more related than distant things.” (Waldo Tobler) The importance of location decision of firms and its consequent effect on knowledge spillovers and innovation intensity of even whole industry has been emphasized in recent studies. *“Innovation has become the defining challenge of global competitiveness; to manage it well, companies must harness the power of location in creating and commercializing new ideas”*. (Porter and Stern, 2001, pp. 28) Clusters as geographical concentration of interconnected companies and institutions in a particular field (See Porter 1998), is an interesting concept appears in economic geography and innovation literature. *“What happens inside companies is important, but clusters reveal that the immediate business environment outside companies plays a vital role as well. This role of location has been long overlooked, despite striking evidence that innovation and competitive success in so many fields are geographically concentrated – whether it’s entertainment in Hollywood, finance on Wall Street or consumer electronics in Japan”*. (Porter, 1998, pp. 78)

[†] Mohammad Ali Kashefi, Ph.D. Student, Bielefeld Graduate School of Economics and Management (BiGSEM), Universitätsstrasse 25, D-33615, Bielefeld, Germany. Tel: +49 (521) 1064864, Email: akashefi@wiwi.uni-bielefeld.de, www.BiGSEM.de

Kashefi

Furthermore recent empirical evidence shows that cost considerations have obtained significant attention relative to market entry and are concerned recently in many cases the main factor affecting firms' location decisions. (See Kinkel and Lay, 2004) Beside factor costs and entry into new markets, some other relevant arguments including availability of skilled labor, the local institutional environment, the size or economic importance of a region in relation to the expected intensity of competition or the possibility to improve production due to technological spillovers from other firms or research institute in the local proximity can affect the location decision of firms.

In this paper a different viewpoint to location decision of firms in the presence of knowledge spillovers is applied. Actually strategic location decision of producers with respect to technological activities of their respected suppliers in a framework of supply chain is examined, which has been studied rarely in literatures. (See Ishii, 2004) Indeed the role of vertical knowledge spillovers between producer and supplier via supply chain is highlighted and distinguished from horizontal knowledge spillovers which occur between two firms from same stream of a market. Here we are eager to respond the question that under which circumstances vertical knowledge spillovers via supply chain lead to geographical concentration.

In this research we try to bind economic geography concepts like isolation or concentration of firms with knowledge spillover context which has origin in R&D literatures which has not done independently and numerically in previous literature. For this purpose a three-stage game theoretic model is established as in the first stage, our economic agents including two suppliers and their respected producers locate in two geographically different regions based on the framework of our model, then in the second stage they invest on R&D activities in the form of marginal cost reduction and finally in the third stage they compete on the amount of output they will produce strategically via Cournot market structure.

2. Literature Review

Several studies have been done so far in the appreciation of geographical concentration e.g. Krugman (1991) has mentioned three reasons for localization: first, the concentration of several firms in a single location offers a pooled market for workers with industry-specific skills, ensuring both a lower probability of unemployment and a lower probability of labor shortage; Second, localized industries can support the production of non tradable specialized inputs and third informational spillovers can give clustered firms a better production function than isolated producers.

Almazan, De Motta and Titman (2007) introduced a model which exhibits that the choice of locating within rather than away from industry clusters is influenced by the extent to which training costs are borne by firm versus employees. Moreover, the uncertainty about future productivity shocks and the ability of firms to modify the scale of their operations also influence location choice.

Moreover, several economists have investigated different aspects of investment on R&D activities e.g. Poyago-Theotoky (1991) established her static game theoretic model based on empirical evidence that the number of cooperative agreements in R&D has increased since 1980s. In her viewpoint R&D cooperation not only leads

Kashefi

firm to engage in more R&D and thus produce more R&D output (in the form of cost reduction) but, in addition, has also the beneficial effect of making firms fully disclose their information. This kind of R&D cooperation is seen to improve own firm profitability and social welfare as it involves lower prices and higher total output relative to non-cooperation. She considered knowledge spillovers endogenously in her model.

Gersbach and Schmutzler (2003) endogenized technological spillovers with a new approach via static game theoretic model in which firms compete for knowledge by making wage offers to each other's R&D employees. They showed that incentives to acquire spillovers and incentives to prevent spillovers are stronger under quantity competition than under price competition.

D'Aspremont and Jacquemin (1988) investigated the effect of cooperation level of firms on social welfare considering duopoly market in the presence of knowledge spillovers. They considered two types of agreements in which in the first one companies share basic information and efforts in the R&D stage but remain rival in the marketplace while in the second case, extended collusion between partners, creating common policies at the product level.

Dawid and Wersching (2007) showed that because of competition effects, technological spillovers as a technological coordination device negatively affect the profits of cluster firms. Moreover Dawid, Greiner and Zou (2010) established a dynamic model of a firm which is deciding whether to outsource parts of its production to a less developed economy where wages and the level of technology are lower. Outsourcing reduces production costs but is associated with spillovers to foreign potential competitors which increase productivity of those firms over time and make them stronger competitor on the common market.

Considering all above mentioned outstanding studies in this filed, this paper focuses on the effects of vertical knowledge spillover between a supplier and its respected producer -which may appear in the form of some R&D cooperation agreements in order to eliminate duplication of R&D efforts- plus horizontal knowledge spillover between two firms of the same stream of the market -which compete with each other in the same marketplace- on the location decision of these agents which may result geographical concentration or isolation. It is often pointed out in the literature that the close relationships between final-good producer and its respected supplier are important for successful innovation efforts. (See von Hippel 1988; Riggs and von Hippel, 1994)

The rest of the paper is organized as follows. In section 2, theoretical model and methodology is presented which will be analyzed in section 3 utilizing numerical approach. The last section concludes and points out possible extensions of the model as well as research limitations.

3. Model and Methodology

Consider an economy including two separated geographical regions $R_i, i = 1, 2$ but treated as one market. Four firms consisting of two suppliers and two producers from the same industry collaborate via their supply chain in the form that S_i is a supplier

Kashefi

of just P_i with $i = 1, 2$. Without loss of generality we assume that upstream suppliers S_i ($i = 1, 2$) produce homogeneous intermediate goods and downstream producers P_i ($i = 1, 2$) produce homogeneous final goods respectively which one unit of intermediate good is required to produce exactly one unit of final good. We investigate two scenarios which in the first one both suppliers are located in the same region, say R_1 , and in the other one suppliers act in different regions.

We utilize a three-stage static game with perfect information: In the first stage, firms locate in two regions R_i ($i = 1, 2$) based on our abovementioned scenarios about suppliers; in the second stage, firms choose their cost-reducing R&D expenditure (Innovation level) X_i for producers and Y_i for suppliers ($i = 1, 2$); in the third stage vertical and horizontal knowledge spillovers exogenously take place given the formation of firms in two regions as well as their innovation efforts and firms compete on standard Cournot market structure to choose the amount of output they will produce strategically.

Figure 2.1

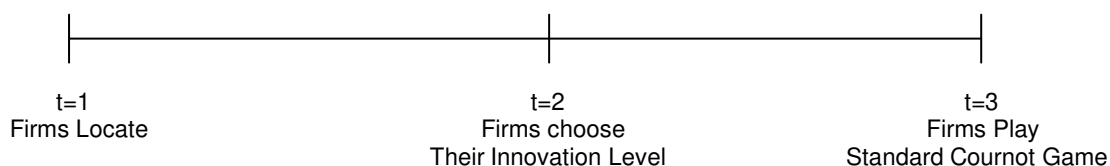

We define here vertical knowledge spillovers as knowledge spillovers between two firms of different stream (Supplier and Producer) via supply chain and can occur between two firms located in the same region β_r or between two firms of different regions β_t , but we assume that regional vertical knowledge spillovers are stronger than the trans-regional vertical one, so $\beta_r > \beta_t$. These exogenous parameters show the proportion of innovation efforts of a firm which might be absorbed by counterparty. Horizontal knowledge spillovers imply spillovers between two firms of a same stream (Two producers or two suppliers) and can happen only when both are located in the same region. We denote it with exogenous parameters $\tilde{\gamma}^p$ for producers and $\tilde{\gamma}^s$ for suppliers ($\tilde{\gamma}^p = \tilde{\gamma}^s = \gamma$ if exist). Moreover we assume that horizontal knowledge spillovers if exist are stronger than vertical one of both types since both producers act as same level firms in the same market, $0 \leq \beta_t < \beta_r < \tilde{\gamma}^p = \tilde{\gamma}^s = \gamma \leq 1$ (If $\tilde{\gamma}^p$, $\tilde{\gamma}^s$ or both exists). In this setting zero implies occurrence of no spillover and one implies perfect spillovers. Indeed the external effect of firm i 's innovation effort is to decrease firm j 's unit production cost.

Linear inverse demand function is utilized given by $P = a - bQ$ ($Q = q_1 + q_2$) and $a/b > 0$ shows the size of the market. $Q < a/b, b > 0$. The inverse demand function is useful in deriving the total and marginal revenue functions. Total revenue equals price P times quantity Q or $TR = P * Q = (a - bQ) * Q$. The marginal revenue function is the first derivative of the total revenue function with respect to Q , that is $MR = a - 2bQ$. The importance of being able to simply calculate MR is that the profit-maximizing

Kashefi

condition for firms regardless of market structure is to produce where marginal revenue equals marginal cost MC , that is $MR = MC$.

Our producers as well as our suppliers are supposed to have similar constant unit cost of transforming intermediate goods \bar{C}_p, \bar{C}_s respectively. By innovation efforts in second stage, their unit cost of production is reduced by X_i for producers and Y_i for suppliers. ($i = 1, 2$)

We assume that intermediate goods are sold by suppliers to producers with constant price \bar{P} , e.g. based on some long-term contractual commitments. $0 < \bar{C}_p + \bar{P} < a$

Therefore, unit cost of production is of the form $C_i = \bar{C}_p - X_i - \beta_i Y_i - \gamma^p X_j + \bar{P}$ such that

$$\beta_i = \begin{cases} \beta_r & \text{if } S_i \text{ and } P_i \text{ are in same region} \\ \beta_l & \text{if } S_i \text{ and } P_i \text{ are in different regions} \end{cases}, \quad \gamma^p = \begin{cases} \tilde{\gamma}^p & \text{if } P_1 \text{ and } P_2 \text{ are in same region} \\ 0 & \text{if } P_1 \text{ and } P_2 \text{ are in different regions} \end{cases} \quad \text{and}$$

$$\gamma^s = \begin{cases} \tilde{\gamma}^s & \text{if } S_1 \text{ and } S_2 \text{ are in same region} \\ 0 & \text{if } S_1 \text{ and } S_2 \text{ are in different regions} \end{cases}. \quad (i, j = 1, 2; X_i + \beta_i Y_i + \gamma^p X_j - \bar{P} \leq \bar{C}_p)$$

Following Qiu (1997), we assume that innovation costs are of the quadratic form $K(X_i) = v_{P_i} (X_i)^2, v_{P_i} > 0$ for producers and $K(Y_i) = v_{S_i} (Y_i)^2, v_{S_i} > 0$ for suppliers respectively ($i = 1, 2$) which implies diminishing returns in R&D.

Profit function of the producing firms $i = 1, 2$ will have the form of $\pi_i^p = (a - bQ)q_i - (\bar{C}_p - X_i - \beta_i Y_i - \gamma^p X_j + \bar{P})q_i - v_{P_i} (X_i)^2$ and for suppliers we have $\pi_i^s = \bar{P}q_i - (\bar{C}_s - Y_i - \gamma^s Y_j - \beta_i X_i)q_i - v_{S_i} (Y_i)^2$.

Methodology: Whereas solving final equation systems involves sophisticated parametric calculations which make the comparison of final payoff functions almost impossible, numerical approach is applied afterwards. Mathematica will be employed to depict us the role of each parameter of our model as well as the sensitivity of these results upon parametrical changes.

We categorize our parameters into three groups including 1. Market parameters: a, b, \bar{P}, \bar{C} 2. Knowledge spillovers parameter: β_r, β_l, γ and 3. Innovation cost parameter: v

For the purpose of simplicity we establish three *assumptions* which we release some of them completely or partially afterwards:

Assumption 1: At the first stage of the game -which firms locate- our first producer (P1), first supplier (S1) and second supplier (S2) has chosen their location exogenously based on the framework of our model in section 3; So we are supposed to investigate the location decision of our second producer (P2) in order to answer our research question upon geographical concentration.

Kashefi

Assumption 2: All parameters are considered to be correspondingly homogeneous. Later we release this assumption with respect to innovation's cost parameter ν .

Assumptions 3: Innovation's cost of our producers is assumed to be infinity so they will not invest on any innovation effort: $X_{P_i}^{jk} = 0$ for $i, j, k = 1, 2$. We will relax this assumption completely afterwards.

4. Analysis and Findings

In this chapter we analyze our model based on two scenarios which we have established on our model regarding the location decision of suppliers. Throughout we are going to find out the location decision of our producers and the postulated equilibrium. In fact we want to answer this question that under which circumstances knowledge spillovers via supply chain lead us to geographical concentration. Backward induction will be applied to find the SPE of our three-stage static game with perfect information. In each scenario, payoff function of both producers in two different cases will be analyzed parametrically; in the first case of each scenario we assume that both producers are located in different regions while in the second case geographical concentration of producers will be compared.

4.1 First Scenario: Two Suppliers are Located in Different Regions

In this scenario we assume that our suppliers have decided to locate in different regions, say R1 and R2. Consequently based on our model horizontal knowledge spillover between them will not appear in our calculations.

4.1.1 Case 1: Two Producers are Located in Different Regions

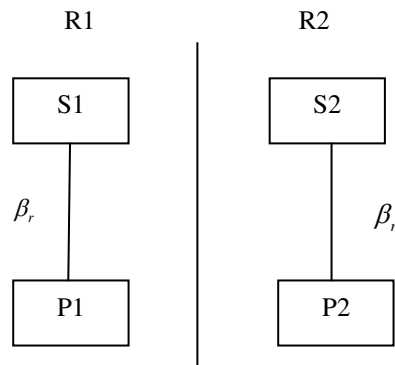

At $t=3$ producers play a standard Cournot duopoly game with the following payoff functions:

$$\pi_{P_1}^{11} = (a - bq_{P_1}^{11} - bq_{P_2}^{11})q_{P_1}^{11} - (\bar{C}_P - X_{P_1}^{11} - \beta_r Y_{S_1}^{11} + \bar{P})q_{P_1}^{11} - \nu_{P_1}^{11} (X_{P_1}^{11})^2$$

$$\pi_{P_2}^{11} = (a - bq_{P_1}^{11} - bq_{P_2}^{11})q_{P_2}^{11} - (\bar{C}_P - X_{P_2}^{11} - \beta_r Y_{S_2}^{11} + \bar{P})q_{P_2}^{11} - \nu_{P_2}^{11} (X_{P_2}^{11})^2$$

Kashefi

In this notation $\pi_{P_1}^{11}$ is the payoff function of the first producer in the first scenario as well as the first case respectively, for example $\pi_{P_2}^{12}$ shows the payoff of the second producer in the second case of the first scenario.

Finding out the optimal value of these payoff functions lead us to solving the following maximization problem:

$$\max_{q_{P_1}^{11}} \pi_{P_1}^{11} \text{ for the first producer and } \max_{q_{P_2}^{11}} \pi_{P_2}^{11} \text{ for the second one.}$$

By F.O.C. we have:

$$\frac{\partial \pi_{P_1}^{11}}{\partial q_{P_1}^{11}} = 0 \quad \text{and} \quad \frac{\partial \pi_{P_2}^{11}}{\partial q_{P_2}^{11}} = 0$$

Nash-Cournot quantities produced by both producers will be reached after some simple calculations,

$$q_{NC1}^{11} = \frac{a - \bar{C}_P + \beta_r (2Y_{S1}^{11} - Y_{S2}^{11}) + 2X_{P1}^{11} - X_{P2}^{11} - \bar{P}}{3b}$$

$$q_{NC2}^{11} = \frac{a - \bar{C}_P + \beta_r (2Y_{S2}^{11} - Y_{S1}^{11}) + 2X_{P2}^{11} - X_{P1}^{11} - \bar{P}}{3b}$$

Consequently optimal payoffs of our producers are:

$$\pi_{P_1}^{*11} = \frac{[a - \bar{C}_P + \beta_r (2Y_{S2}^{11} - Y_{S1}^{11}) + 2X_{P2}^{11} - X_{P1}^{11} - \bar{P}]^2}{9b} - v_{P_1}^{11} (X_{P_1}^{11})^2$$

$$\pi_{P_2}^{*11} = \frac{[a - \bar{C}_P + \beta_r (2Y_{S1}^{11} - Y_{S2}^{11}) + 2X_{P1}^{11} - X_{P2}^{11} - \bar{P}]^2}{9b} - v_{P_2}^{11} (X_{P_2}^{11})^2$$

At $t=2$ firms decide on their innovation level $X_{P_i}^{11}$ and $Y_{S_j}^{11}$ as well. ($i, j = 1, 2$) Payoff functions of suppliers are as follow:

$$\pi_{S_1}^{11} = \bar{P} \cdot q_{NC1}^{11} - (\bar{C}_S - Y_{S_1}^{11} - \beta_r X_{P_1}^{11}) q_{NC1}^{11} - v_{S_1}^{11} (Y_{S_1}^{11})^2$$

$$\pi_{S_2}^{11} = \bar{P} \cdot q_{NC2}^{11} - (\bar{C}_S - Y_{S_2}^{11} - \beta_r X_{P_2}^{11}) q_{NC2}^{11} - v_{S_2}^{11} (Y_{S_2}^{11})^2$$

Optimal innovation level of each firm arises from solving four maximization problems strategically as one system; indeed each one is going to maximize its payoff function as follow:

$$\begin{cases} \max_{X_{P1}^{11}} \pi_{P1}^{*11} \\ \max_{X_{P2}^{11}} \pi_{P2}^{*11} \\ \max_{Y_{S1}^{11}} \pi_{S1}^{11} \\ \max_{Y_{S2}^{11}} \pi_{S2}^{11} \end{cases}$$

Subject to four following constraints respectively:

$$\begin{cases} 0 \leq \bar{C}_P - X_{P1}^{11} - \beta_r Y_{S1}^{11} + \bar{P} \leq a \\ 0 \leq \bar{C}_P - X_{P2}^{11} - \beta_r Y_{S2}^{11} + \bar{P} \leq a \\ 0 \leq \bar{C}_S - Y_{S1}^{11} - \beta_r X_{P1}^{11} \leq \bar{P} \\ 0 \leq \bar{C}_S - Y_{S2}^{11} - \beta_r X_{P2}^{11} \leq \bar{P} \end{cases}$$

4.1.2 Case 2: Two Producers are Located in Same Region

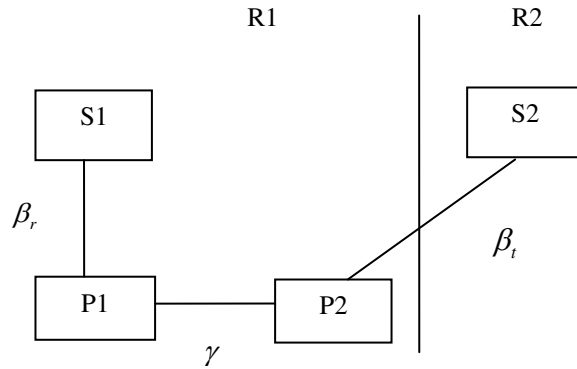

Geographical concentration of producers will be investigated by this case. Similarly, at $t=3$ producers play a standard Cournot duopoly game with the following payoff functions:

$$\pi_{P1}^{12} = (a - bq_{P1}^{12} - bq_{P2}^{12})q_{P1}^{12} - (\bar{C}_P - X_{P1}^{12} - \beta_r Y_{S1}^{12} - \gamma X_{P2}^{12} + \bar{P})q_{P1}^{12} - v_{P1}^{12} (X_{P1}^{12})^2$$

$$\pi_{P2}^{12} = (a - bq_{P1}^{12} - bq_{P2}^{12})q_{P2}^{12} - (\bar{C}_P - X_{P2}^{12} - \beta_t Y_{S2}^{12} - \gamma X_{P1}^{12} + \bar{P})q_{P2}^{12} - v_{P2}^{12} (X_{P2}^{12})^2$$

Maximization of these two payoff functions with respect to relevant quantities as we did in previous case give us Nash-Cournot quantities as follow:

$$q_{NC1}^{12} = \frac{a - \bar{C}_P + 2\beta_r Y_{S1}^{12} - \beta_t Y_{S2}^{12} + 2X_{P1}^{12} - (1-\gamma)X_{P2}^{12} - \bar{P}}{3b}$$

$$q_{NC2}^{12} = \frac{a - \bar{C}_P + 2\beta_r Y_{S2}^{12} - \beta_t Y_{S1}^{12} + 2X_{P2}^{12} - (1-\gamma)X_{P1}^{12} - \bar{P}}{3b}$$

Kashefi

Thus optimal values of our producers' payoff functions are as below:

$$\pi_{P1}^{*12} = \frac{[a - \bar{C}_P + 2\beta_r Y_{S1}^{12} - \beta_t Y_{S2}^{12} + 2X_{P1}^{12} - (1-\gamma)X_{P2}^{12} - \bar{P}]^2}{9b} - v_{P1}^{12} (X_{P1}^{12})^2$$

$$\pi_{P2}^{*12} = \frac{[a - \bar{C}_P + 2\beta_r Y_{S2}^{12} - \beta_t Y_{S1}^{12} + 2X_{P2}^{12} - (1-\gamma)X_{P1}^{12} - \bar{P}]^2}{9b} - v_{P2}^{12} (X_{P2}^{12})^2$$

Similarly proceeding backward, at t=2 firms decide on their optimal innovation level X_{Pi}^{12} and Y_{Sj}^{12} as well. ($i, j = 1, 2$) Payoff functions of suppliers are as follow:

$$\pi_{S1}^{12} = \bar{P} \cdot q_{NC1}^{12} - (\bar{C}_S - Y_{S1}^{12} - \beta_r X_{P1}^{12}) q_{NC1}^{12} - v_{S1}^{12} (Y_{S1}^{12})^2$$

$$\pi_{S2}^{12} = \bar{P} \cdot q_{NC2}^{12} - (\bar{C}_S - Y_{S2}^{12} - \beta_r X_{P2}^{12}) q_{NC2}^{12} - v_{S2}^{12} (Y_{S2}^{12})^2$$

Optimal innovation level of each firm arises from solving four maximization problems strategically as one system; indeed each one is going to maximize its payoff function as follow:

$$\left\{ \begin{array}{l} \max_{X_{P1}^{12}} \pi_{P1}^{*12} \\ \max_{X_{P2}^{12}} \pi_{P2}^{*12} \\ \max_{Y_{S1}^{12}} \pi_{S1}^{12} \\ \max_{Y_{S2}^{12}} \pi_{S2}^{12} \end{array} \right.$$

With respect to the following four constraints respectively:

$$\left\{ \begin{array}{l} 0 \leq \bar{C}_P - X_{P1}^{12} - \beta_r Y_{S1}^{12} - \gamma X_{P2}^{12} + \bar{P} \leq a \\ 0 \leq \bar{C}_P - X_{P2}^{12} - \beta_r Y_{S2}^{12} - \gamma X_{P1}^{12} + \bar{P} \leq a \\ 0 \leq \bar{C}_S - Y_{S1}^{12} - \beta_r X_{P1}^{12} \leq \bar{P} \\ 0 \leq \bar{C}_S - Y_{S2}^{12} - \beta_r X_{P2}^{12} \leq \bar{P} \end{array} \right.$$

4.2 Second Scenario: Two Suppliers are Located in Same Region

Contrary to the first scenario, in the second one whereas our suppliers are located in the same region, say R1, horizontal knowledge spillover between them emerges in both respective cases depicted with parameter γ .

4.2.1 Case 1: Two Producers are Located in Different Regions

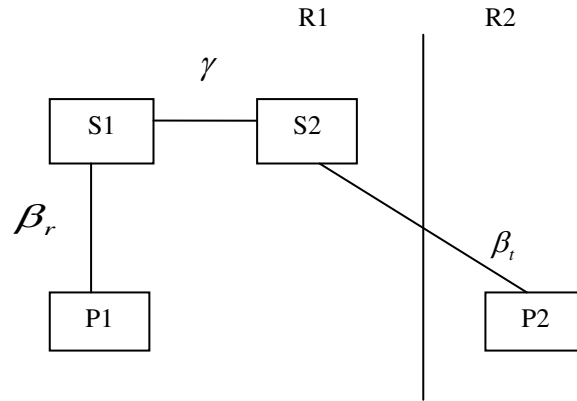

Applying backward induction, at t=3 producers play a standard Cournot duopoly game with the following payoff functions:

$$\pi_{P1}^{21} = (a - bq_{P1}^{21} - bq_{P2}^{21})q_{P1}^{21} - (\bar{C}_P - X_{P1}^{21} - \beta_r Y_{S1}^{21} + \bar{P})q_{P1}^{21} - v_{P1}^{21} (X_{P1}^{21})^2$$

$$\pi_{P2}^{21} = (a - bq_{P1}^{21} - bq_{P2}^{21})q_{P2}^{21} - (\bar{C}_P - X_{P2}^{21} - \beta_t Y_{S2}^{21} + \bar{P})q_{P2}^{21} - v_{P2}^{21} (X_{P2}^{21})^2$$

Nash-Cournot quantities are the result of maximization process over these payoff functions with respect to q_{P1}^{21} & q_{P2}^{21} respectively:

$$q_{NC1}^{21} = \frac{a - \bar{C}_P + 2\beta_r Y_{S1}^{21} - \beta_t Y_{S2}^{21} + 2X_{P1}^{21} - X_{P2}^{21} - \bar{P}}{3b}$$

$$q_{NC2}^{21} = \frac{a - \bar{C}_P + 2\beta_t Y_{S2}^{21} - \beta_r Y_{S1}^{21} + 2X_{P2}^{21} - X_{P1}^{21} - \bar{P}}{3b}$$

After plugging these optimal quantities into payoff functions of producers, following optimal values of them arise:

$$\pi_{P1}^{*21} = \frac{[a - \bar{C}_P + 2\beta_r Y_{S1}^{21} - \beta_t Y_{S2}^{21} + 2X_{P1}^{21} - X_{P2}^{21} - \bar{P}]^2}{9b} - v_{P1}^{21} (X_{P1}^{21})^2$$

$$\pi_{P2}^{*21} = \frac{[a - \bar{C}_P + 2\beta_t Y_{S2}^{21} - \beta_r Y_{S1}^{21} + 2X_{P2}^{21} - X_{P1}^{21} - \bar{P}]^2}{9b} - v_{P2}^{21} (X_{P2}^{21})^2$$

Proceeding backward, at t=2 firms decide upon their innovation level X_{Pi}^{21} and Y_{Sj}^{21} as well. ($i, j = 1, 2$) Profit functions of our suppliers are as follow:

$$\pi_{S1}^{21} = \bar{P} \cdot q_{NC1}^{21} - (\bar{C}_S - Y_{S1}^{21} - \beta_r X_{P1}^{21} - \gamma Y_{S2}^{21})q_{NC1}^{21} - v_{S1}^{21} (Y_{S1}^{21})^2$$

$$\pi_{S2}^{21} = \bar{P} \cdot q_{NC2}^{21} - (\bar{C}_S - Y_{S2}^{21} - \beta_t X_{P2}^{21} - \gamma Y_{S1}^{21})q_{NC2}^{21} - v_{S2}^{21} (Y_{S2}^{21})^2$$

Optimal innovation level of each firm will deduce from maximization of their respective payoff functions strategically as a four-equations-four-unknowns system:

$$\begin{cases} \max_{X_{P1}^{21}} \pi_{P1}^{*21} \\ \max_{X_{P2}^{21}} \pi_{P2}^{*21} \\ \max_{Y_{S1}^{21}} \pi_{S1}^{21} \\ \max_{Y_{S2}^{21}} \pi_{S2}^{21} \end{cases}$$

With respect to the following four constraints respectively:

$$\begin{cases} 0 \leq \bar{C}_p - X_{P1}^{21} - \beta_r Y_{S1}^{21} + \bar{P} \leq a \\ 0 \leq \bar{C}_p - X_{P2}^{21} - \beta_t Y_{S2}^{21} + \bar{P} \leq a \\ 0 \leq \bar{C}_s - Y_{S1}^{21} - \beta_r X_{P1}^{21} - \gamma Y_{S2}^{21} \leq \bar{P} \\ 0 \leq \bar{C}_s - Y_{S2}^{21} - \beta_t X_{P2}^{21} - \gamma Y_{S1}^{21} \leq \bar{P} \end{cases}$$

4.2.2 Case 2: Two Producers are Located in Same Region

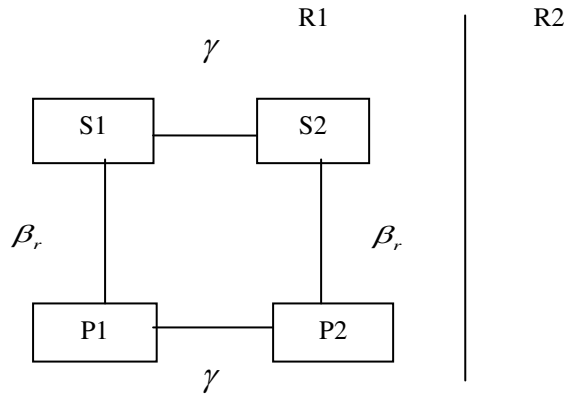

Geographical concentration of producers in the second scenario will be investigated via this case. Incidentally horizontal knowledge spillovers between two producers as well as two suppliers exist in this case which induce flow of knowledge through our four firms depicted by parameters β_r, γ .

By using backward induction, at $t=3$ producers play a standard Cournot duopoly game with the below mention payoff functions:

$$\begin{aligned} \pi_{P1}^{22} &= (a - bq_{P1}^{22} - bq_{P2}^{22})q_{P1}^{22} - (\bar{C}_p - X_{P1}^{22} - \beta_r Y_{S1}^{22} - \gamma X_{P2}^{22} + \bar{P})q_{P1}^{22} - v_{P1}^{22} (X_{P1}^{22})^2 \\ \pi_{P2}^{22} &= (a - bq_{P1}^{22} - bq_{P2}^{22})q_{P2}^{22} - (\bar{C}_p - X_{P2}^{22} - \beta_r Y_{S2}^{22} - \gamma X_{P1}^{22} + \bar{P})q_{P2}^{22} - v_{P2}^{22} (X_{P2}^{22})^2 \end{aligned}$$

By solving First-Order-Condition equations of both producers as a one system, maximum Nash-Cournot value of our quantities have the following form:

Kashefi

$$q_{NC1}^{22} = \frac{a - \bar{C}_P + 2\beta_r Y_{S1}^{22} - \beta_r Y_{S2}^{22} + 2X_{P1}^{22} - (1-\gamma)X_{P2}^{22} - \bar{P}}{3b}$$

$$q_{NC2}^{22} = \frac{a - \bar{C}_P + 2\beta_r Y_{S2}^{22} - \beta_r Y_{S1}^{22} + 2X_{P2}^{22} - (1-\gamma)X_{P1}^{22} - \bar{P}}{3b}$$

Consequently optimal payoff functions of our producers are as follow:

$$\pi_{P1}^{*22} = \frac{[a - \bar{C}_P + 2\beta_r Y_{S1}^{22} - \beta_r Y_{S2}^{22} + 2X_{P1}^{22} - (1-\gamma)X_{P2}^{22} - \bar{P}]^2}{9b} - v_{P1}^{22} (X_{P1}^{22})^2$$

$$\pi_{P2}^{*22} = \frac{[a - \bar{C}_P + 2\beta_r Y_{S2}^{22} - \beta_r Y_{S1}^{22} + 2X_{P2}^{22} - (1-\gamma)X_{P1}^{22} - \bar{P}]^2}{9b} - v_{P2}^{22} (X_{P2}^{22})^2$$

Proceeding backward, at t=2 firms decide on their innovation level X_{Pi}^{22} and Y_{Sj}^{22} as well. ($i, j = 1, 2$) Payoff functions of suppliers are as follow:

$$\pi_{S1}^{22} = \bar{P} \cdot q_{NC1}^{22} - (\bar{C}_S - Y_{S1}^{22} - \beta_r X_{P1}^{22} - \gamma Y_{S2}^{22}) q_{NC1}^{22} - v_{S1}^{22} (Y_{S1}^{22})^2$$

$$\pi_{S2}^{22} = \bar{P} \cdot q_{NC2}^{22} - (\bar{C}_S - Y_{S2}^{22} - \beta_r X_{P2}^{22} - \gamma Y_{S1}^{22}) q_{NC2}^{22} - v_{S2}^{22} (Y_{S2}^{22})^2$$

Similar to our previous cases, optimal level of innovation of our firms will be resulted by strategically solving a four-equations-four-unknowns system of equations as follow:

$$\left\{ \begin{array}{l} \max_{X_{P1}^{22}} \pi_{P1}^{*22} \\ \max_{X_{P2}^{22}} \pi_{P2}^{*22} \\ \max_{Y_{S1}^{22}} \pi_{S1}^{22} \\ \max_{Y_{S2}^{22}} \pi_{S2}^{22} \end{array} \right.$$

Providing the satisfaction of the four below mention constraints respectively:

$$\left\{ \begin{array}{l} 0 \leq \bar{C}_P - X_{P1}^{22} - \beta_r Y_{S1}^{22} - \gamma X_{P2}^{22} + \bar{P} \leq a \\ 0 \leq \bar{C}_P - X_{P2}^{22} - \beta_r Y_{S2}^{22} - \gamma X_{P1}^{22} + \bar{P} \leq a \\ 0 \leq \bar{C}_S - Y_{S1}^{22} - \beta_r X_{P1}^{22} - \gamma Y_{S2}^{22} \leq \bar{P} \\ 0 \leq \bar{C}_S - Y_{S2}^{22} - \beta_r X_{P2}^{22} - \gamma Y_{S1}^{22} \leq \bar{P} \end{array} \right.$$

4.3 Findings

4.3.1 Producers Do NOT Invest on any Innovation Effort

In the first phase of our analysis for the purpose of simplicity and based on assumption 3, we ignore any innovation effort of our both producers. Obviously with this assumption in hand horizontal knowledge spillovers between producers will not occur. We will relax this assumption for broader analysis later.

Kashefi

Observation 1: In the first scenario and in the absence of innovation efforts of both producers, the first case which shows the geographical isolation is the equilibrium.

As we have established in the first scenario both suppliers are located in different regions and consequently there is no horizontal knowledge spillover between them. As a result the only channel of innovation's disclosure is through vertical knowledge spillovers characterized by parameters β_r & β_t which $0 \leq \beta_t < \beta_r \leq 1$. Comparison between two cases of this scenario shows us that the second producer will find it more profitable locating itself in the different region in order to obtain innovation effort of its respective supplier via regional -rather than trans regional- vertical knowledge spillover which will decline its costs more. Obviously the first producer will prefer the second case over the first one. Because he will compete with a producer who could reduce his costs with the factor $\beta_t < \beta_r$, but it is not equilibrium while second producer will tend to deviate to the first case and locate in different region.

More precisely speaking, we can consider following graphs showed in figure 4.3.1.1 which help us to compare the payoffs of producers in these cases. As depicted in this set of graphs, the first producer clearly prefers the occurrence of second case in which he will obtain more profit from the market while the second producers dominantly prefers the first case getting more payoffs. Suppliers have the same behavior symmetrically.

Observation 2: In the second scenario and in the absence of innovation efforts of both producers, the second case which shows the geographical concentration is the equilibrium.

In this scenario horizontal knowledge spillovers between two suppliers which is characterized by γ , exist. Similar to the interpretation of the previous observation, in this scenario our second producer dominantly prefers geographical concentration which depicted in the second case. Consequently he is able to reduce his costs based on the knowledge spillovers factor $\beta_r > \beta_t$ which will not be in the favor of first producer who prefers to be alone in the first region as depicted in the first case. But based on assumption 1 second case of this scenario would be the equilibrium. Although locating of both suppliers is exogenous, their behavior can be interpreted similarly. On the other hand first producer prefers first case in which his competitor is able to share his knowledge with second supplier via trans-regional vertical knowledge spillover that is smaller than regional one.

Figure 4.3.1.2 exhibits the comparison of payoffs of our economic agents in two different cases of this scenario which support above mentioned reasoning.

When R&D efforts of both producers were ignored as we did in this subsection, our observations show strong robustness upon parametrical changes. Broad ranges of parameters have been checked numerically in this part in order to guarantee the final results.

Kashefi

Figure 4.3.1.1:
First Scenario: Two Suppliers are located in Different Regions (Yellow: Case1 & Red: Case2)

$$(a = 100, b = 2, \beta_i = 0.05, \gamma = 0.2, v_{P_1} = v_{P_2} = v_{S_1} = 0.7)$$

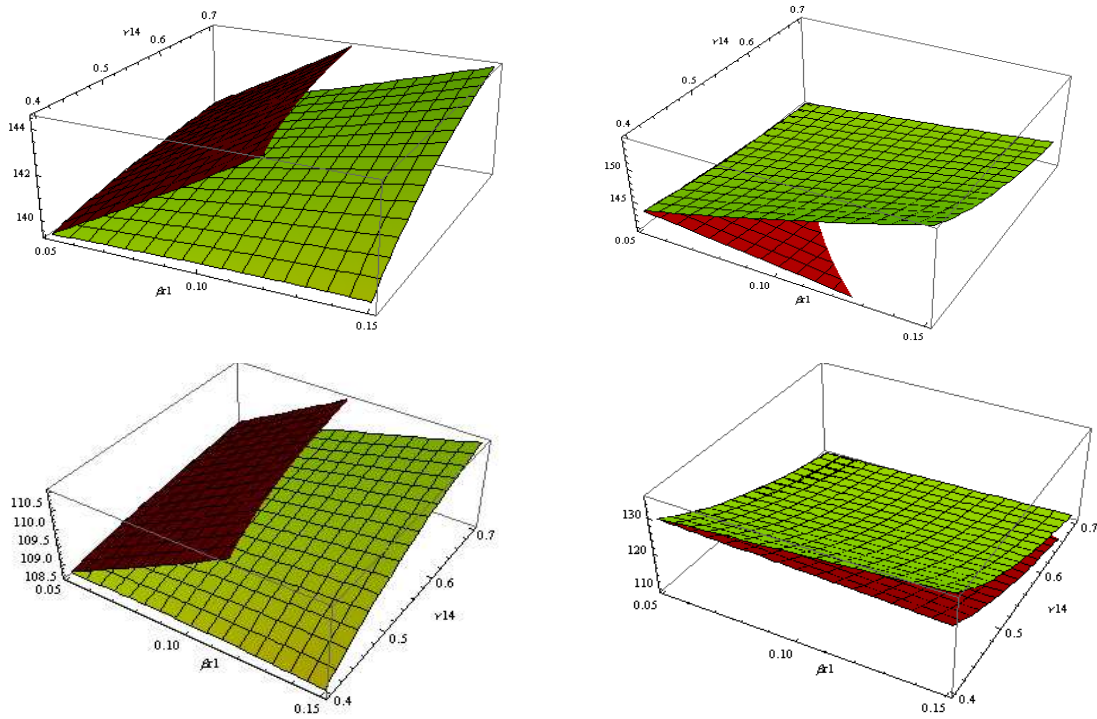
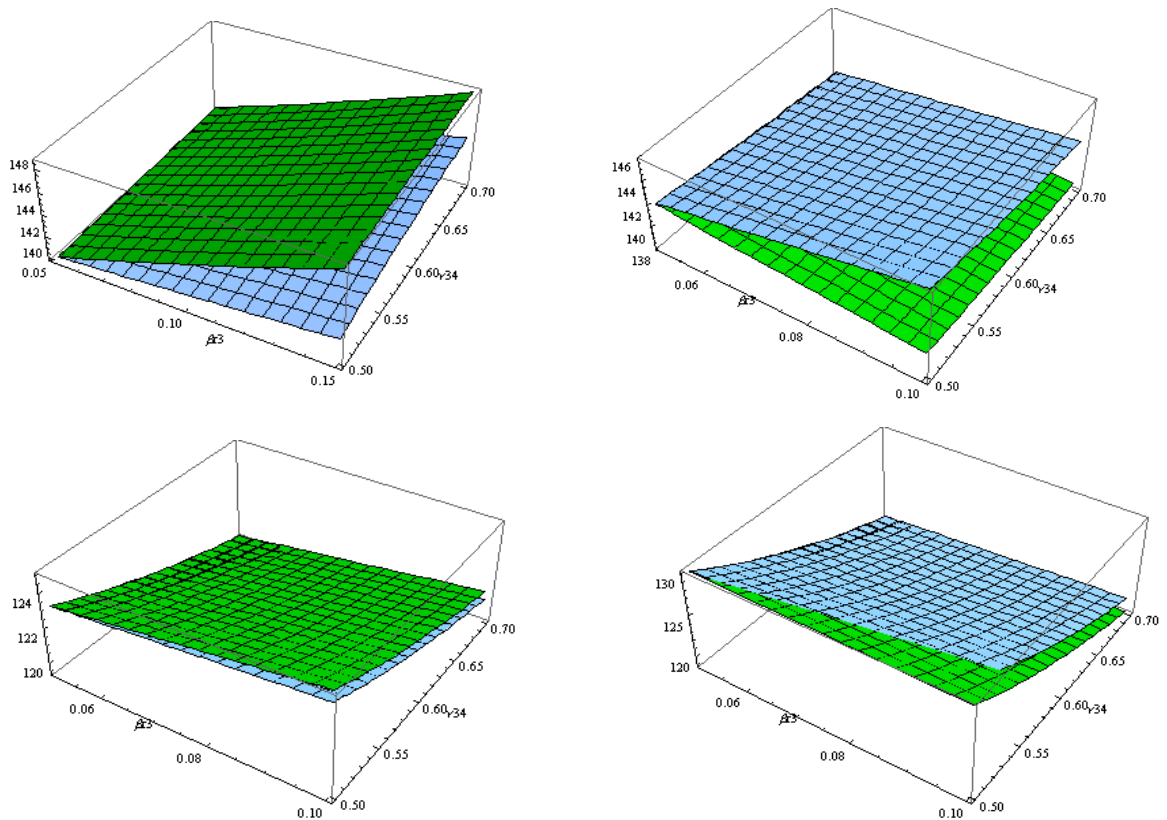

Figure 4.3.1.2:
Second Scenario: Two Suppliers are located in Same Region (Green: Case1 & Blue: Case2)

$$(a = 100, b = 2, \beta_i = 0.05, \gamma = 0.2, v_{P_1} = v_{P_2} = v_{S_1} = 0.7)$$



4.3.2 Producers Enter Innovation Efforts

In this section we relax assumption 3 and consider the innovation efforts of both producers in our analysis. Obviously in this situation horizontal knowledge spillovers between two producers which characterized by γ will play an important role affecting final outcomes. Furthermore based on assumption 2, horizontal knowledge spillovers between two suppliers as well as two producers are assumed to be homogeneous, that is $\gamma_{suppliers} = \gamma_{producers} = \gamma$.

In the previous section 4.3.1 the results were completely robust with respect to postulated parameters which categorized in section 3 and no deviation from our mentioned equilibrium occurred during numerical analysis and parametric changes, but in this section we examine the robustness and sustainability of our observations according to categorization of our parameters.

Observation 3: In the first scenario and in the presence of innovation efforts of both producers, the second case which shows the geographical concentration is the equilibrium.

Observation 4: In the second scenario and in the presence of innovation efforts of both producers, the second case which shows the geographical concentration is the equilibrium.

4.3.2.1 Comparative Static

In order to realize the effect of each parameter on our outcomes, and supporting the robustness of observations 3 and 4, we investigate comparative static in this subsection. For this purpose two sets of parameters –based on our categorization in section 3 - are being fixed and the parametrical effects of the third set are being analyzed. Broad ranges of parameters have been checked in order to ensure us about robustness of our observation upon parametrical changes, but some limited examples could be mentioned here.

4.3.2.1.1 Market Parameters

Providing other parameters are supposed to be fixed, we investigate the effect of our market parameters which characterized by a, b, \bar{P}, \bar{C} on equilibria and location decision of our agents. Utilizing numerical approach we consider the impact of altering the market parameters on equilibrium expressed in observations 3 and 4. In the first scenario as depicted in figures 4.3.2.1.1.1 and 4.3.2.1.1.2 second producer prefers second case over the first one implying geographical concentration. Altering the size of the market as well as the unit cost of production and price does not affect the location decision of our producers.

Altering the size of the market indeed just affect the profit value of agents proportionally and has not any effect on location decision of them. Actually paying attention to 'Markup' index of agents in this model clarifies this matter more. In fact any reduction in the size of the market will decline the quantity produced by our agents which cause them to decrease innovation efforts in order to reach marginal profits in the market. Contrary is valid when market size goes up, but whereas our agents doing business in the same market, these changes affect all proportionally.

Kashefi

Similar interpretations could be applied for the second scenario in which all agents dominantly prefer clustering structure over the first case. Figures 4.3.2.1.1.3 and 4.3.2.1.1.4 confirm our claim.

Comprehensive parametric analysis has been done in this subsection to ensure us upon robustness of observations including broad range of reservation price, market size, unit cost of transforming intermediate goods \bar{C} and different value of intermediate good's price \bar{P} .

4.3.2.1.2 Knowledge Spillover Parameters

For the sake of more accurate analysis we arrange a relation between knowledge spillover parameters based on the framework of our model, in which we have assumed that $0 \leq \beta_i < \beta_r < \gamma \leq 1$. Hence we suppose that $\beta_r = \alpha\beta_i = \delta\gamma$ such that $\alpha > 1$ and $0 < \delta < 1$.

In the first scenario second producer would be able to decline its costs from two source of knowledge, its relevant supplier in the different region as well as the first producer in the same region with knowledge spillover factors β_i and γ respectively. Numerical analysis shows that the effect of these two factors is more than the effect of regional vertical knowledge spillover factor β_r alone. Figures 4.3.2.1.2.1 – 4.3.2.1.2.3 exhibit the different selection of knowledge spillover parameters subject to holding the other parameters fixed. Moreover as depicted in these figures the first producer also prefers second case over the first one which demonstrate his tendency to geographical concentration in which he is able to obtain knowledge from two sources with the factors β_r and γ while his competitor will lose some customers of the common market because of higher costs of production. Thus although the second producer will obtain lower payoff than his competitor he will locate himself near him in order to exploit his innovation efforts which would create better outcome for both of them.

The behavior of our suppliers is a little bit more interesting. The first supplier dominantly prefers the second case over the first one in which he will always have competitive advantage over his rival. He obtains cost-reducing knowledge with two factors β_r and γ while his competitor just can do it via β_i and γ . Our respected figures depict that clearly, but in figure 4.3.2.1.2.3 where we have no explicit difference between knowledge spillover parameters β_r, β_i, γ the second producer will also reach more profit in the second case. Consequently our second supplier prefers the symmetric structure of first case when the amount of our knowledge spillover factors is meaningfully different.

In the second scenario all of our agents do agree to compete and collaborate with each other in a cluster, so geographical concentration would be dominantly preferred by them. If second producer chooses the isolated region, directly he could be able just to obtain the knowledge via his relevant supplier with the parameter β_i . Moreover he will lose the chance to exchange his knowledge with his competitor in the market. When second producer were a stronger innovative firm in the market with higher technology level, this kind of isolation decision might mean more, but in this section based on assumption 2 we have assumed that innovation costs is similar between all

agents. We will relax this assumption later. This equilibrium shows strong robustness upon changing the parameters.

4.3.2.1.3 Innovation Cost Parameter

The last group of parameter which we are going to analyze is innovation cost characterized by ν and assumed to be homogenous. We will investigate the heterogeneity of this parameter which means different technological level between our agents in the next section.

Following Qiu (1997) we have assumed that innovation cost are of the form $K(X_{Pi}^{jk}) = \nu(X_{Pi}^{jk})^2$, $\nu > 0$ and $i, j, k = 1, 2$ for producers as well as $K(Y_{Si}^{jk}) = \nu(Y_{Si}^{jk})^2$, $\nu > 0$ and $i, j, k = 1, 2$ for suppliers which implies diminishing returns in R&D.

Figure 4.3.2.1.3.1 depicts that in the first scenario if innovation cost is altered homogeneously second producer prefers geographical concentration over isolation which is also a preferred situation for the first producer and supplier and our second supplier is somewhat indifferent between two cases.

Providing innovation cost assumed to be homogenous, any increase in this cost enforces our agents to decline R&D efforts which decline their final profit proportionally, but does not affect location decision of them. Inversely high technological firms with lower level of innovation cost will do more R&D activities which decline their total costs and consequently increase the final payoff.

Similarly as depicted in figure 4.3.2.1.3.2 in the second scenario all agents prefer to compete and collaborate with each other in the same geographical region.

Figure 4.3.2.1.1.1:
First Scenario: Two Suppliers are located in Different Regions with a=100, b=2
(Green: Case1 & Red: Case2)

$$(\beta_r = 0.1, \beta_t = 0.05, \gamma = 0.2, \nu_{P_i} = \nu_{S_i} = 0.7)$$

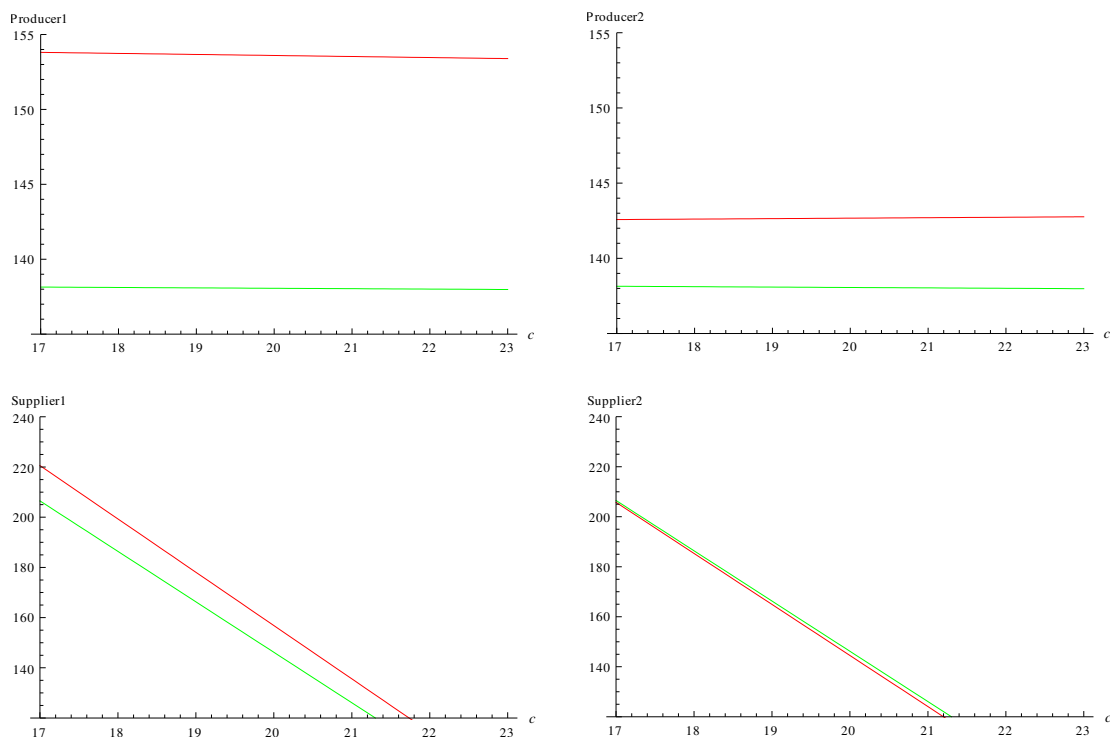

Kashefi

Figure 4.3.2.1.1.2:

First Scenario: Two Suppliers are located in Different Regions with $a=40$, $b=2$
 (Black: Case1 & Blue: Case2)

$$(\beta_r = 0.1, \beta_t = 0.05, \gamma = 0.2, v_{P_i} = v_{S_i} = 0.7)$$

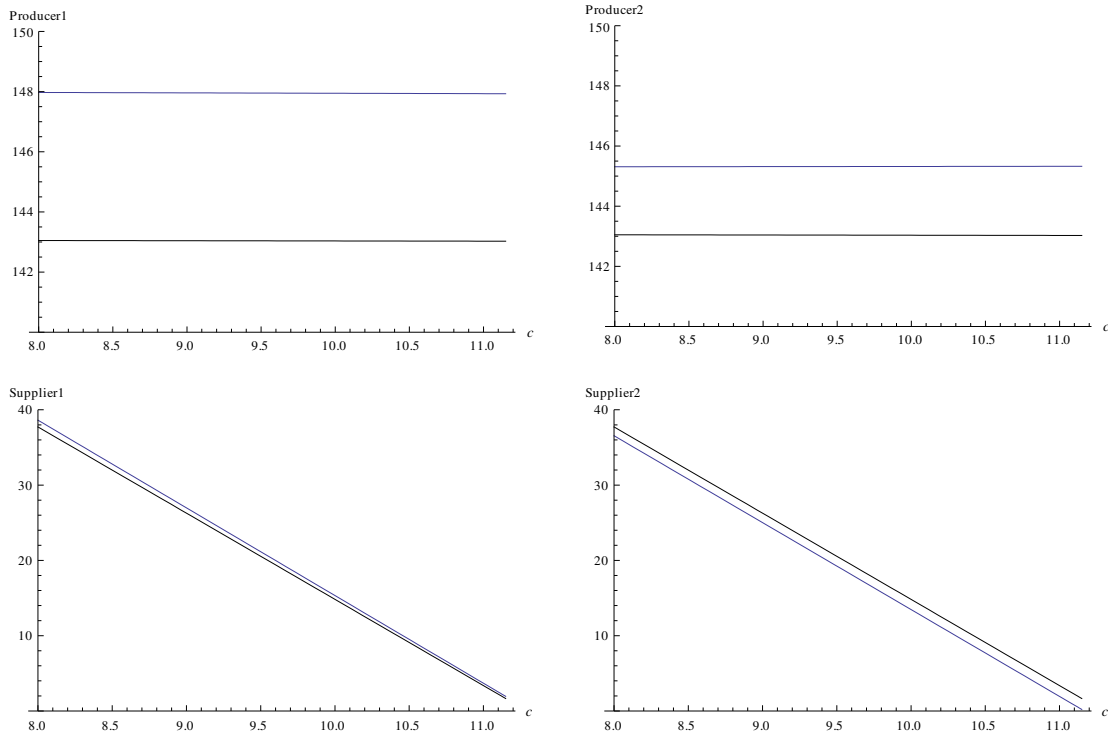
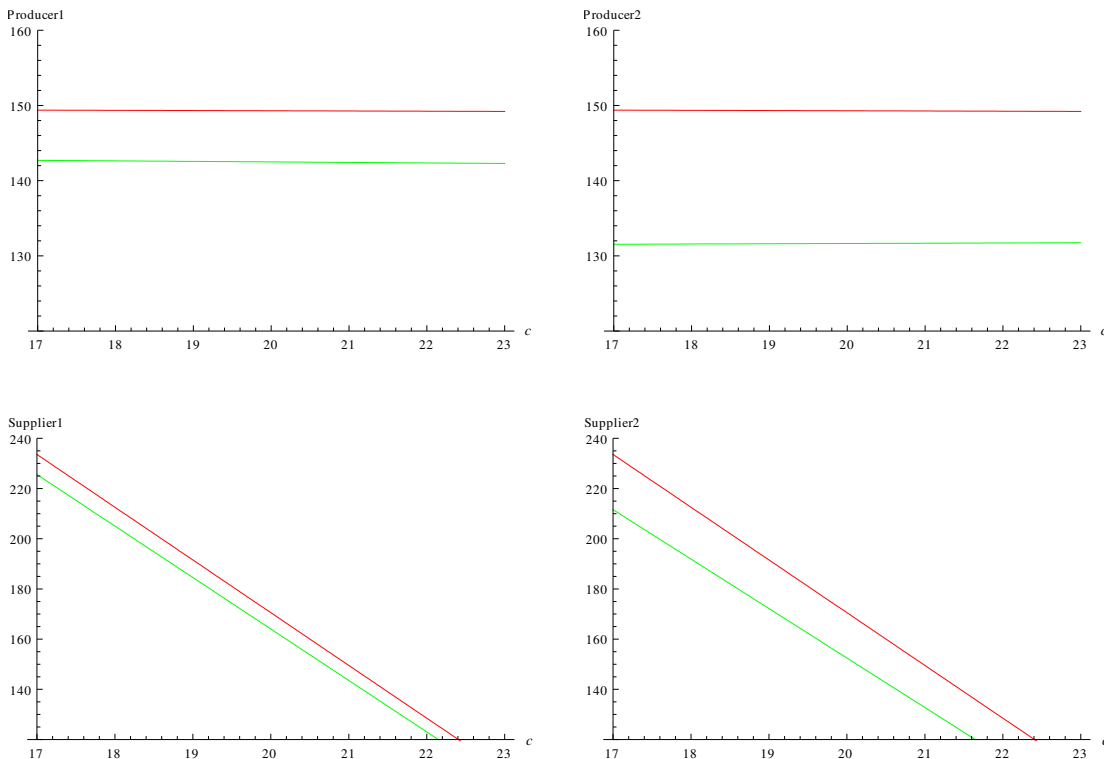

Figure 4.3.2.1.1.3:

Second Scenario: Two Suppliers are located in Same Region with $a=100$, $b=2$
 (Green: Case1 & Red: Case2)

$$(\beta_r = 0.1, \beta_t = 0.05, \gamma = 0.2, v_{P_i} = v_{S_i} = 0.7)$$



Kashefi

Figure 4.3.2.1.1.4:
Second Scenario: Two Suppliers are located in Same Region with $a=40, b=2$
(Black: Case1 & Blue: Case2)

$$(\beta_r = 0.1, \beta_t = 0.05, \gamma = 0.2, v_{P_i} = v_{S_i} = 0.7)$$

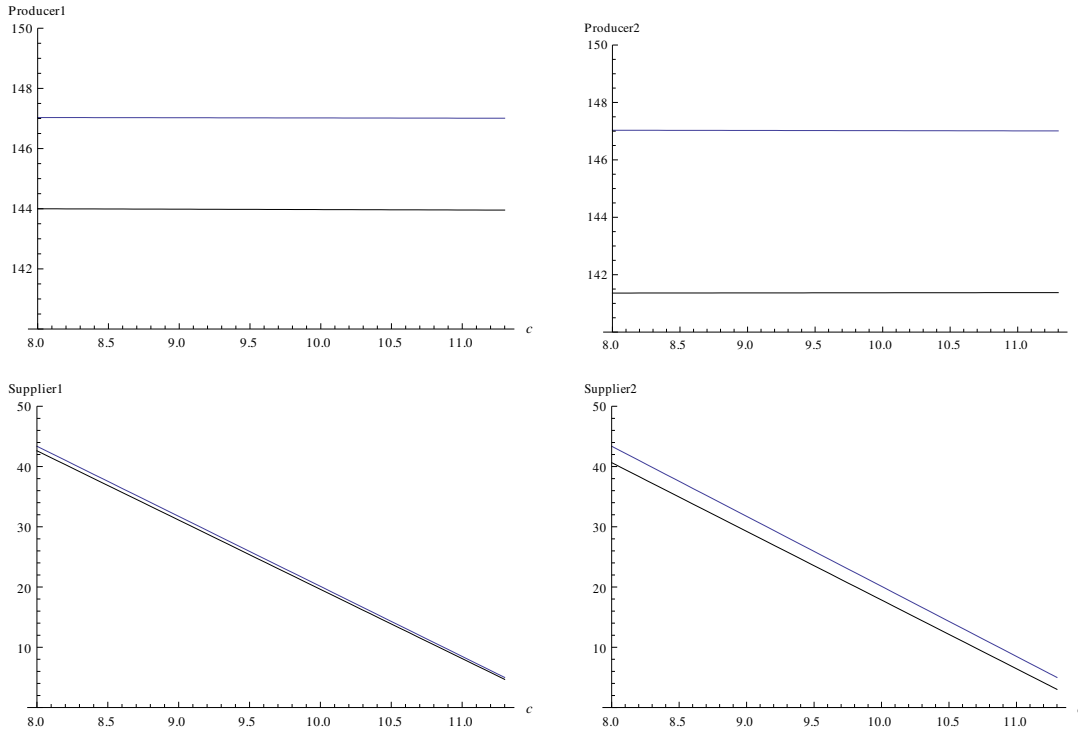
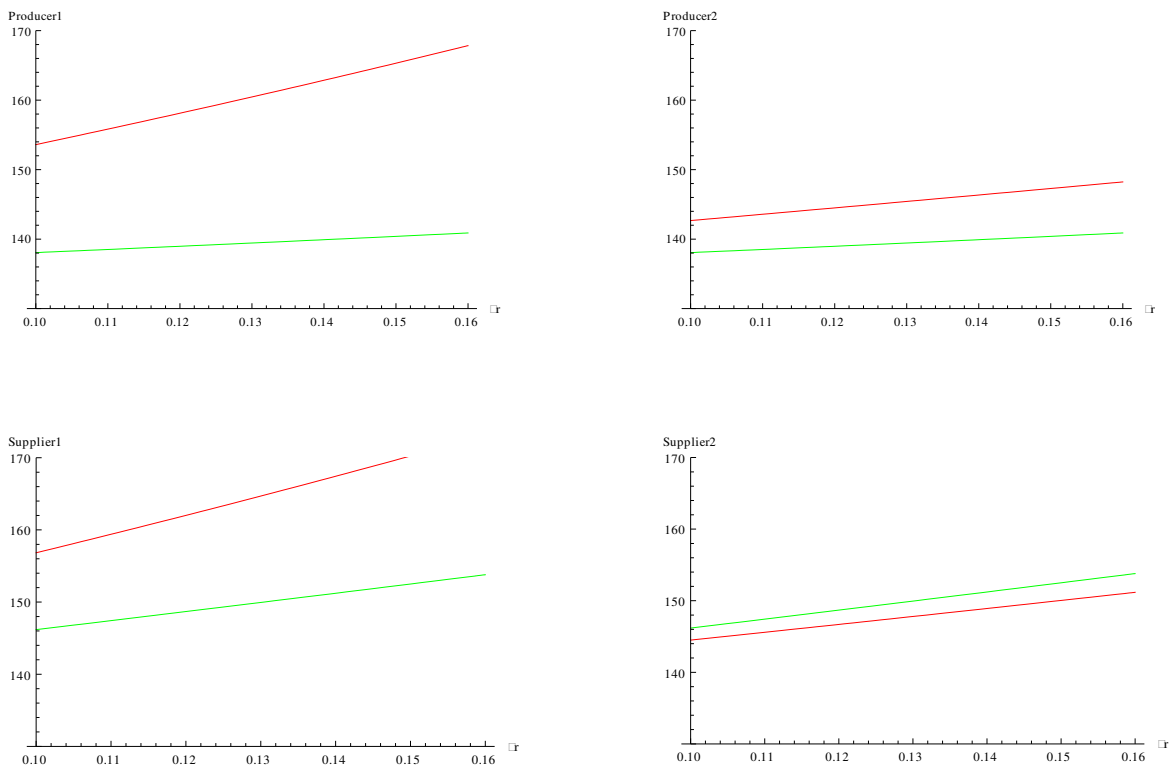

Figure 4.3.2.1.2.1:
First Scenario: Two Suppliers are located in Different Regions with
 $\alpha = 2, \delta = 0.5$ (Green: Case1 & Red: Case2)

$$(a = 100, b = 2, \bar{P} = 30, \bar{C} = 20, v_{P_i} = v_{S_i} = 0.7)$$



Kashefi

Figure 4.3.2.1.2.2:
First Scenario: Two Suppliers are located in Different Regions with
 $\alpha = 1.1, \delta = 0.9$ (Black: Case1 & Blue: Case2)

$$(a = 100, b = 2, \bar{P} = 30, \bar{C} = 20, v_{P_i} = v_{S_i} = 0.7)$$

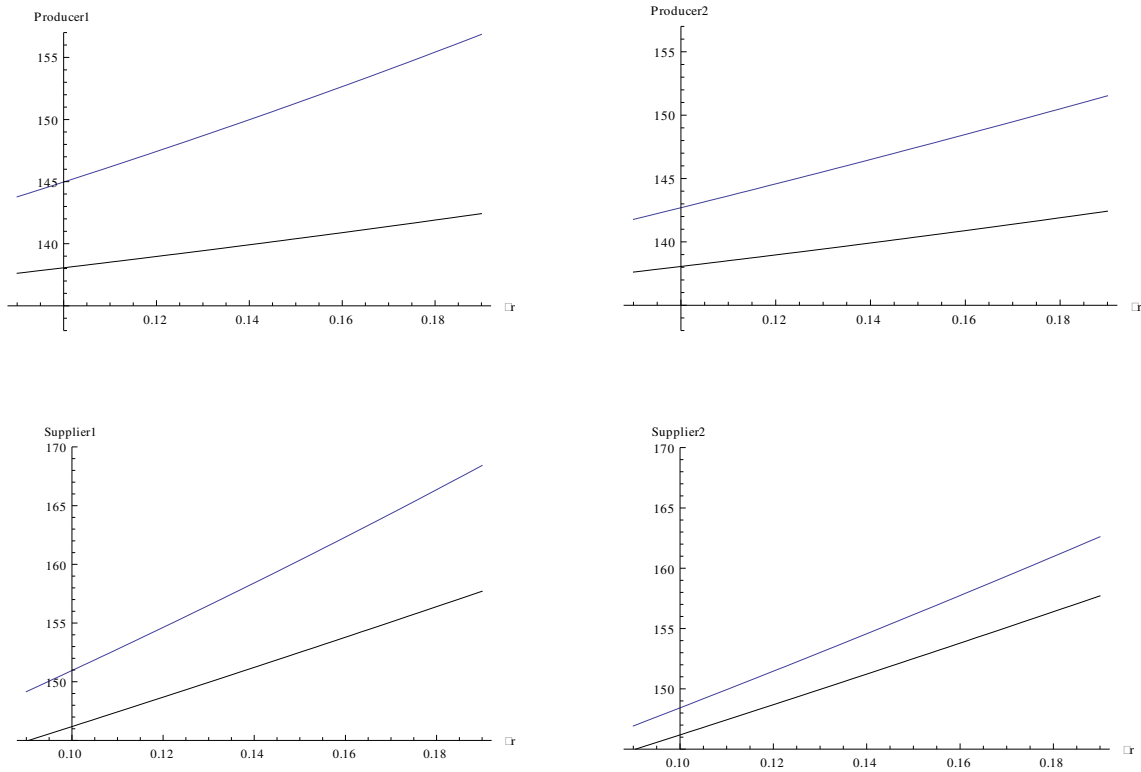
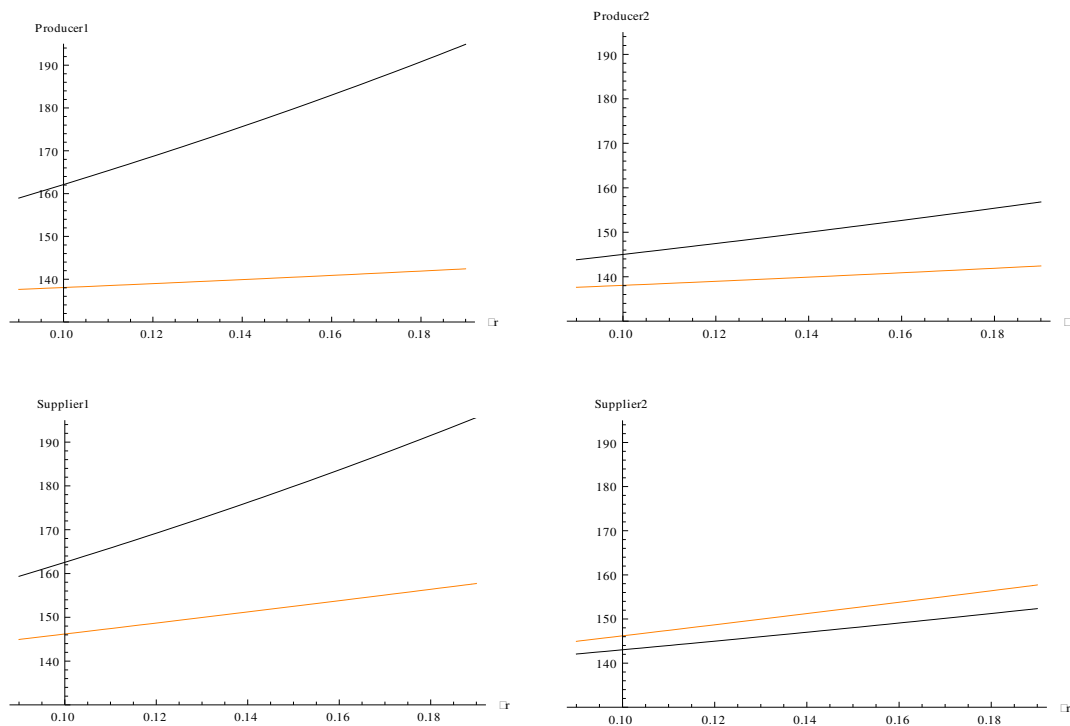

Figure 4.3.2.1.2.3:
First Scenario: Two Suppliers are located in Different Regions with
 $\alpha = 5, \delta = 0.33$ (Orange: Case1 & Black: Case2)

$$(a = 100, b = 2, \bar{P} = 30, \bar{C} = 20, v_{P_i} = v_{S_i} = 0.7)$$



Kashefi

Figure 4.3.2.1.2.4:
Second Scenario: Two Suppliers are located in Same Region with $\alpha = 2, \delta = 0.5$
(Green: Case1 & Red: Case2)

$$(a = 100, b = 2, \bar{P} = 30, \bar{C} = 20, v_{P_i} = v_{S_i} = 0.7)$$

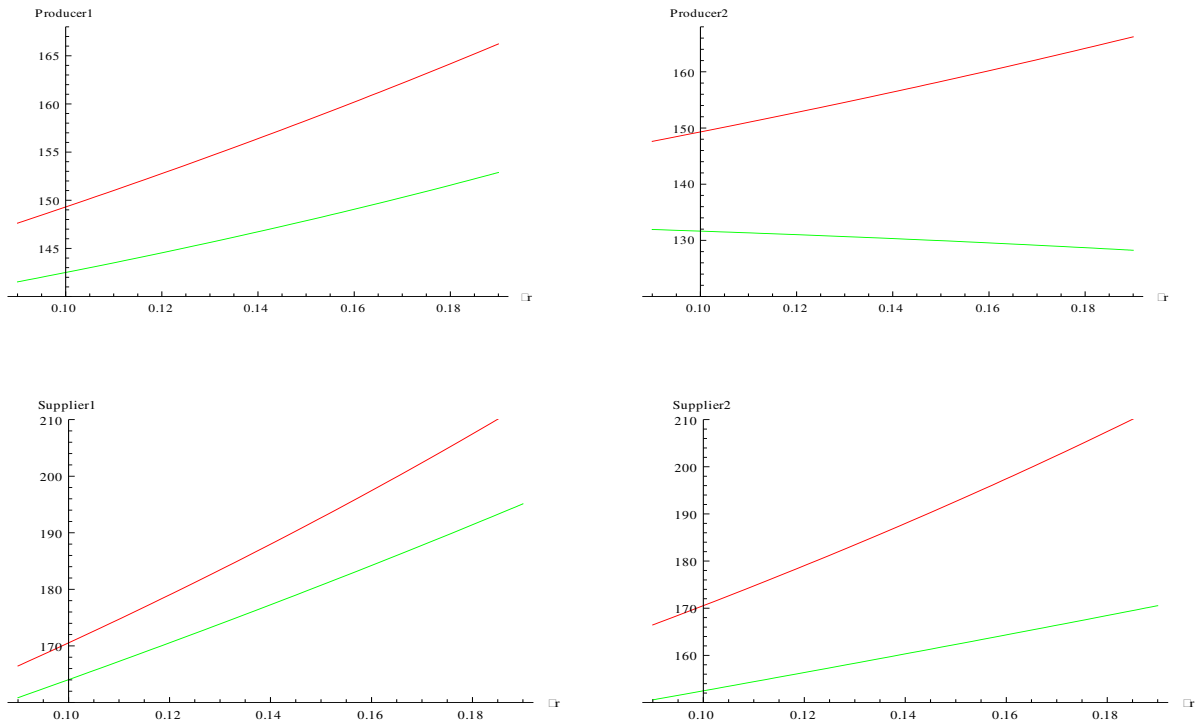
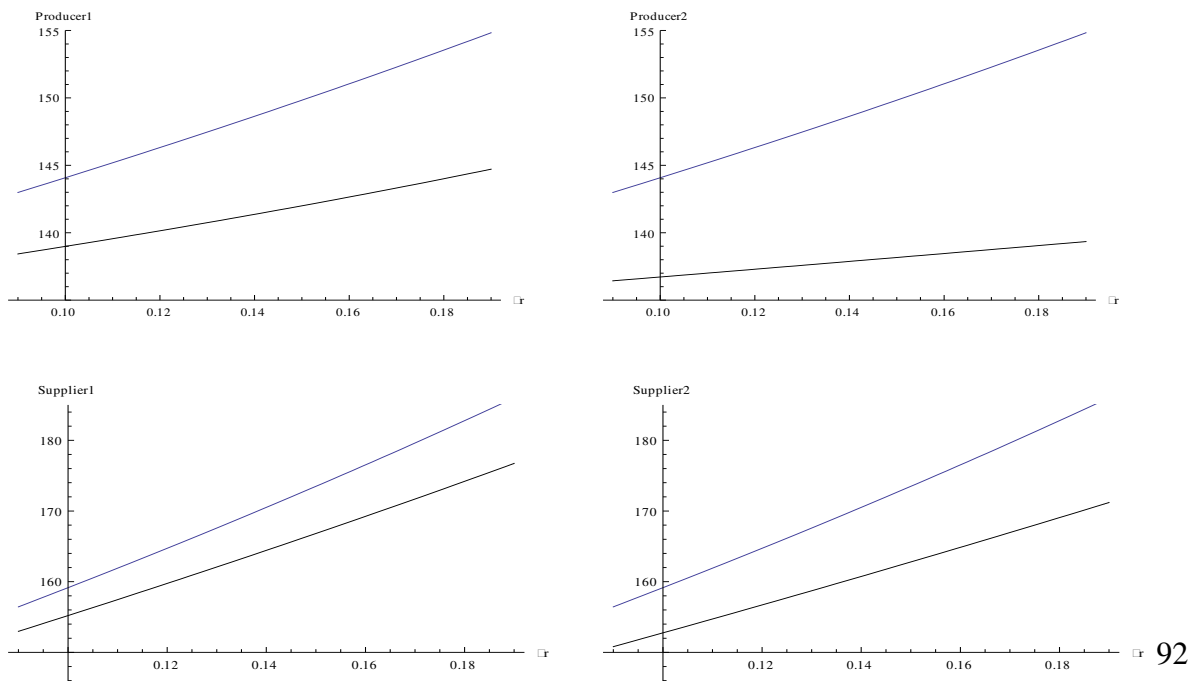

Figure 4.3.2.1.2.5:
Second Scenario: Two Suppliers are located in Same Region with
 $\alpha = 1.1, \delta = 0.9$ (Black: Case1 & Blue: Case2)

$$(a = 100, b = 2, \bar{P} = 30, \bar{C} = 20, v_{P_i} = v_{S_i} = 0.7)$$



Kashefi

Figure 4.3.2.1.2.6:
Second Scenario: Two Suppliers are located in Same Region with $\alpha = 5, \delta = 0.33$
(Orange: Case1 & Black: Case2)

$$(a = 100, b = 2, \bar{P} = 30, \bar{C} = 20, v_{P_i} = v_{S_i} = 0.7)$$

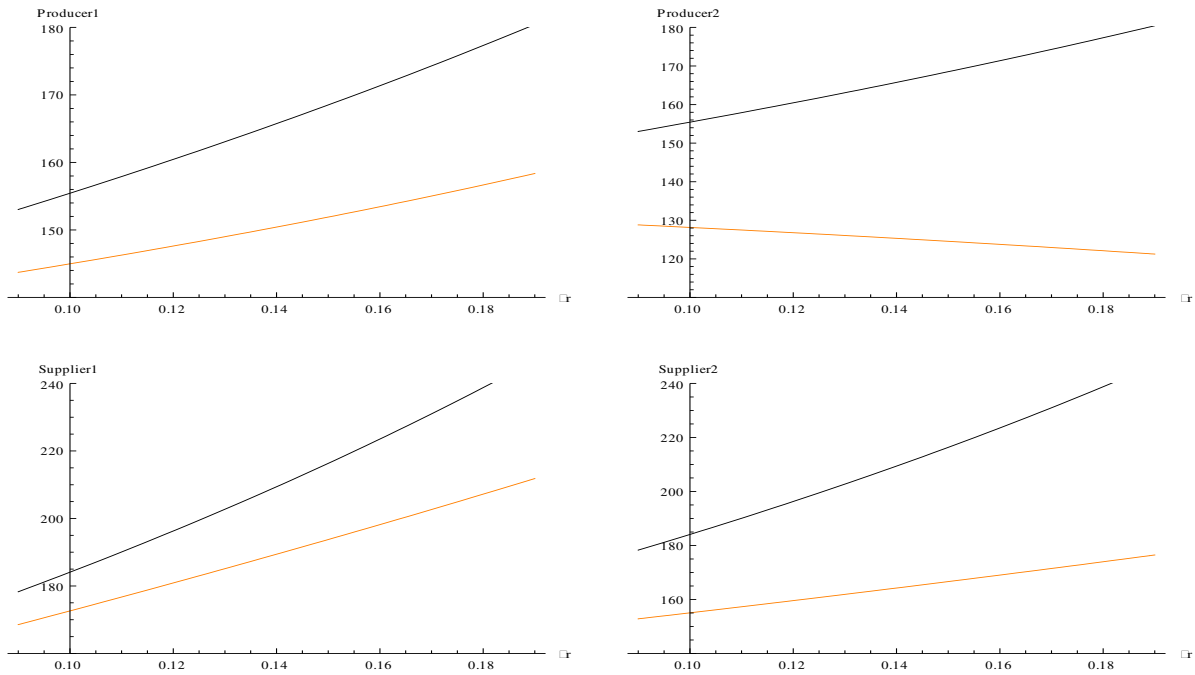
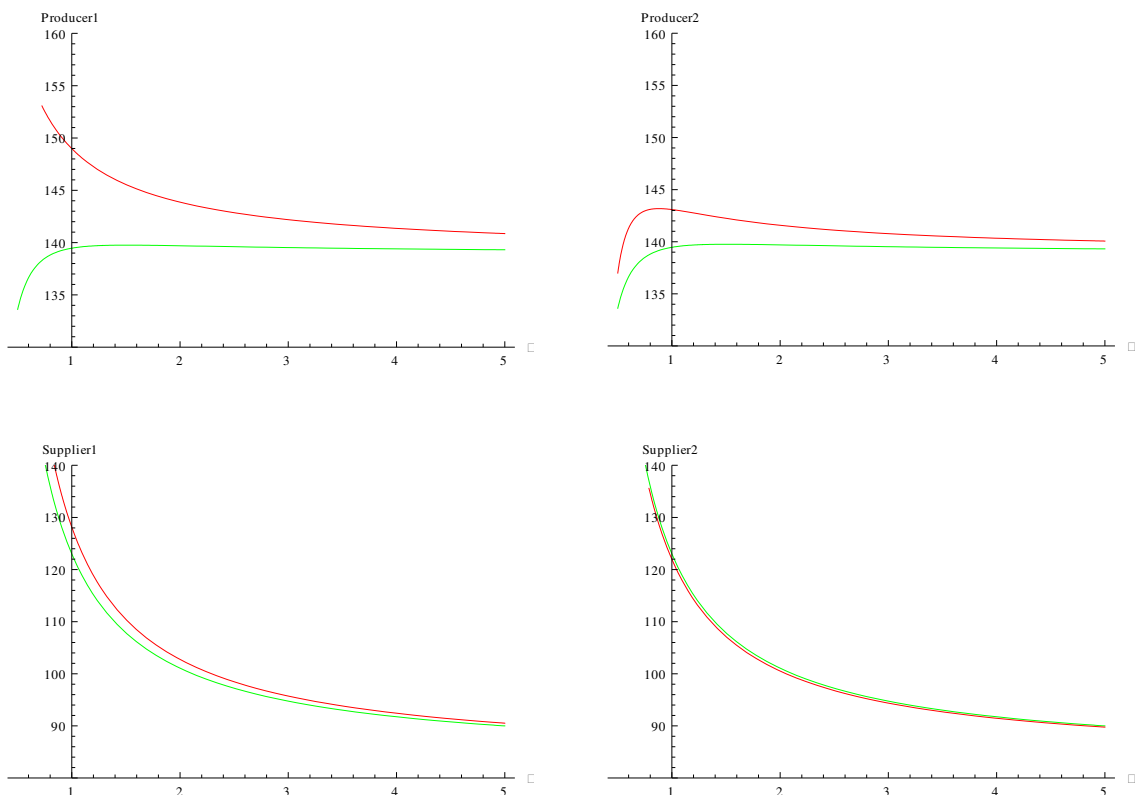

Figure 4.3.2.1.3.1:
First Scenario: Two Suppliers are located in Different Regions (Green: Case1 & Red: Case2)

$$(a = 100, b = 2, \bar{P} = 30, \bar{C} = 20, \beta_r = 0.1, \beta_l = 0.05, \gamma = 0.2)$$



Kashefi

Figure 4.3.2.1.3.2:
Second Scenario: Two Suppliers are located in Same Region (Green: Case1 & Red: Case2)

$$(a = 100, b = 2, \bar{P} = 30, \bar{C} = 20, \beta_r = 0.1, \beta_t = 0.05, \gamma = 0.2)$$

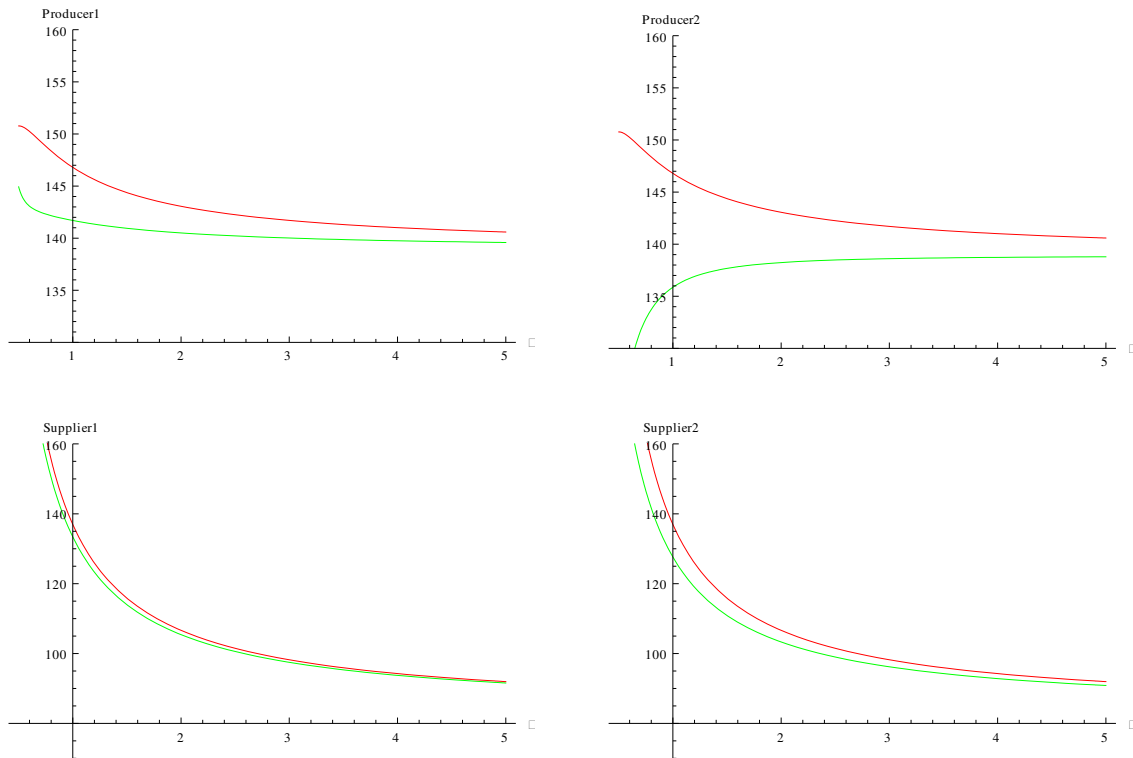

4.3.3 Heterogeneity of Innovation Cost

So far we assumed that technological level of our four agents is similar and characterized by homogeneous innovation cost, but in this section we relax assumption 2 partially and investigate the effect of heterogeneous innovation cost on location decision of firms. In fact we move one step toward real world businesses in which companies actually act with different technological level and there are some evidences that these differences can affect the location decision of firms as well. A prominent example in this regard is Microsoft, which became the industry leader after locating in Seattle, which at the time was not a centre for software development (Almazan 2007). For this purpose we consider two different scenarios which may exist and analyze the model accordingly.

4.3.3.1 Innovation Cost is Heterogeneous just among Different Producer-Supplier Pair

In this subsection we suppose that homogenous innovation cost imposes to first supplier and his respected producer in supply chain as well as the second supplier-producer set while we have heterogeneity of innovation cost among these both pairs. So we normalize the innovation cost of second producer and his respected supplier to one while vary the innovation cost of first pair over an interval $\{0.5, 5\}$. The reason of choosing this interval is that innovation costs which are less than half will not

Kashefi

satisfy our constraints in optimization problem and amounts more than 5 will decline R&D efforts of firms dramatically such that the impact of knowledge spillovers goes down.

Observation 5: In the first scenario considering conditions of subsection 4.3.3.1, when $v_{P_1} = v_{S_1} < \rho$, second case which shows geographical concentration is the equilibrium, while with $\rho \leq v_{P_1} = v_{S_1}$, first case which shows geographical isolation is the equilibrium such that the exact amount of ρ depends on the value of our parameters.

In the first scenario for our first pair of producer-supplier is always of preference to act within concentration structure because regardless of the technological level of both pair, they obtain knowledge via γ which reduce their cost and increase their final outcome. On the other hand our second pair alters his location decision based on the level of technological differences, that is our second producer when encounter a technological level ρ times higher than his respected rival will find it more profitable to keep his physical distance from him and act in isolation as depicted in the first case to avoid any horizontal information disclosure. Figure 4.3.3.1.1 demonstrates the schematic results in which $\rho = 1.8$.

Observation 6: In the Second scenario considering conditions of subsection 4.3.3.1, second case which shows geographical concentration is the equilibrium. Here our second producer dominantly prefers geographical concentration which enables him to receive knowledge from other agents with higher disclosure rate. Figure 4.3.3.1.2 depicts the result.

4.3.3.2 Heterogeneous Innovation Cost Imposes just on Second Producer

Now we investigate whether a very high-tech firm, that is here our second producer, with low innovation cost choose isolation structure to keep its knowledge capital or not. Hence, homogeneous innovation cost for first producer and both suppliers has been set to five and we change the innovation cost of second producer over the interval $\{0.5, 0.7\}$ parametrically. In fact by setting the innovation cost of other agents to a big value like five, we treat them as low technological level firms. On the other hand we change the innovation cost of our second producer over the interval $\{0.5, 0.7\}$ which implies higher technological level in comparison with other agents. For the sake of more accurate results we consider two different levels of horizontal knowledge spillover $\gamma = 0.2$ and $\gamma = 0.12$ to be more sensitive on the effect of innovation cost. Indeed by choosing $\gamma = 0.12$ rather than $\gamma = 0.2$ we try to investigate the situation of more outward knowledge spillovers' protection.

Observation 7: In the first scenario considering conditions of subsection 4.3.3.2, first case is weakly preferred by the second producer which resulted geographical isolation as equilibrium.

Here our second producer weakly prefers to locate himself far from first producer in order to avoid leakage of information to his rival. Although the results are not strong here and when innovation cost of second producer tend to 0.7 we face some kind of

Kashefi

indifference behavior, but dominant preference of second supplier who really makes profit by being alone with his customer might cause some agreements in the real world which commit our first producer to stay in isolation. Figures 4.3.3.2.1 and 4.3.3.2.3 show the graphs for $\gamma = 0.2$ and $\gamma = 0.12$, and the result is robust upon parametrical changes.

Observation 8: In the Second scenario considering conditions of subsection 4.3.3.2, second case which shows geographical concentration is the equilibrium.

Although our second producer is more high-tech against other agents but he prefers to stay in concentration structure to benefit from disclosure of knowledge, but our numerical analysis show a weak preferences in this situation. Clearly other agents appreciate his presence near them.

Figure 4.3.3.2.2 and 4.3.3.2.4 exhibit the results for $\gamma = 0.2$ and $\gamma = 0.12$ respectively, and the result is completely robust upon parametrical changes.

Figure 4.3.3.1.1:
First Scenario: Two Suppliers are located in Different Regions (Black: Case 1 & Blue: Case 2)

$$(a = 100, b = 2, \bar{C} = 20, \bar{P} = 30, \beta_r = 0.1, \beta_t = 0.05, \gamma = 0.2, v_{P_2} = v_{S_2} = 1)$$

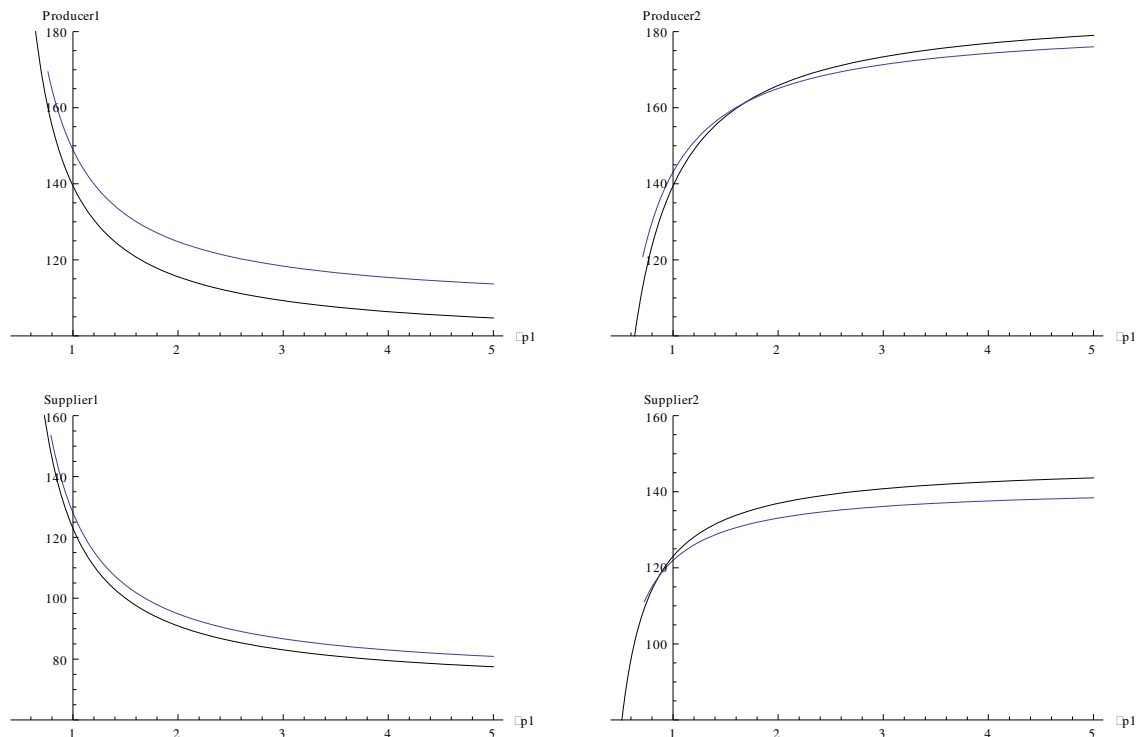

Kashefi

Figure 4.3.3.1.2:
Second Scenario: Two Suppliers are located in Same Region (Black: Case 1 & Blue: Case 2)

$$(a = 100, b = 2, \bar{C} = 20, \bar{P} = 30, \beta_r = 0.1, \beta_l = 0.05, \gamma = 0.2, v_{P_2} = v_{S_2} = 1)$$

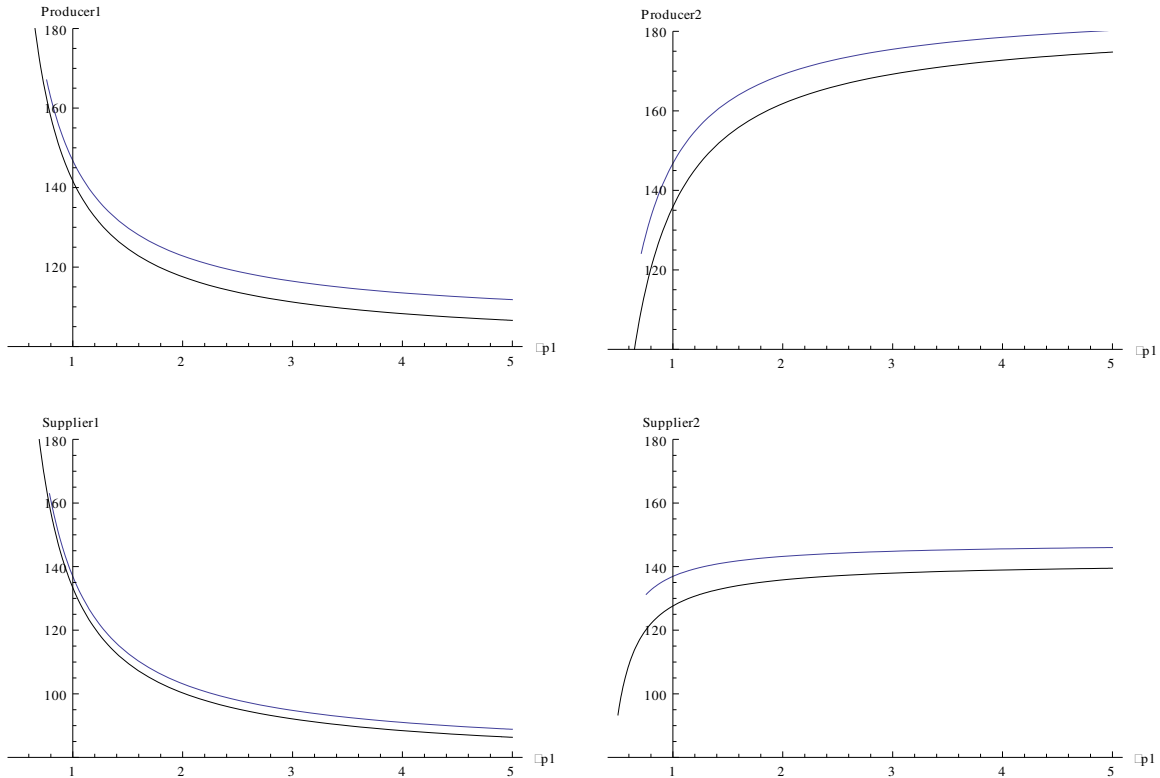
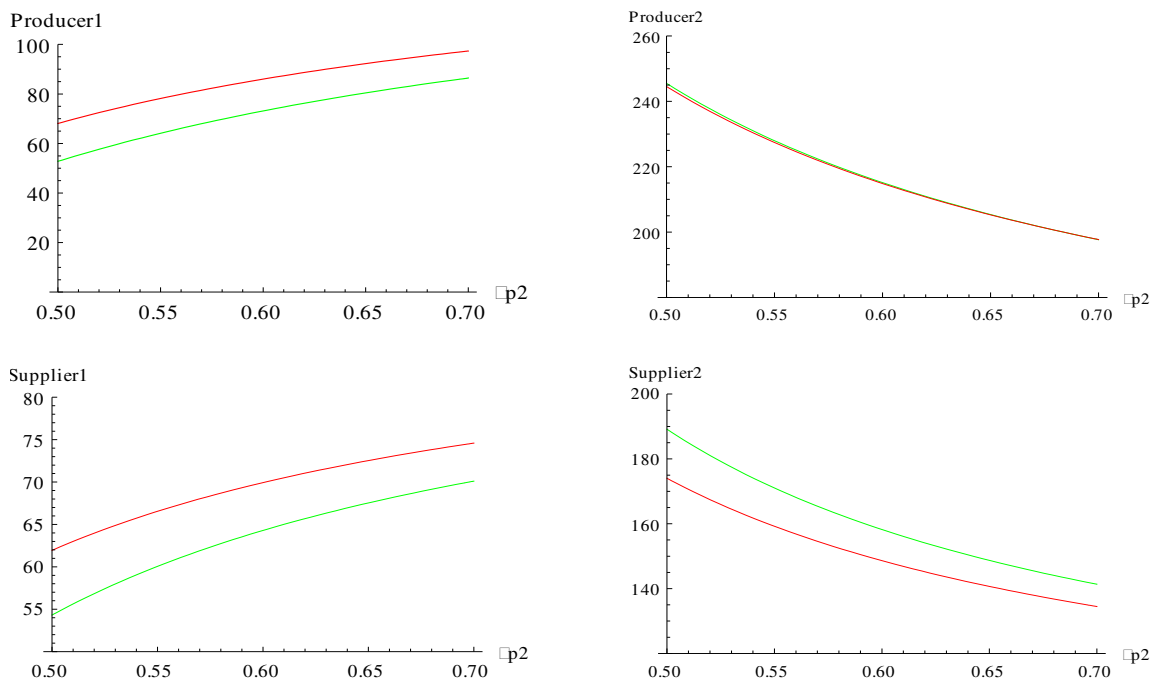

Figure 4.3.3.2.1:
First Scenario: Two Suppliers are located in Different Regions with $\gamma = 0.2$
(Green: Case 1 & Red: Case 2)

$$(a = 100, b = 2, \bar{C} = 20, \bar{P} = 30, \beta_r = 0.1, \beta_l = 0.05, v_{P_1} = v_{S_1} = v_{S_2} = 5)$$



Kashefi

Figure 4.3.3.2:
Second Scenario: Two Suppliers are located in Same Region with $\gamma = 0.2$
(Green: Case 1 & Red: Case 2)

$$(a=100, b=2, \bar{C}=20, \bar{P}=30, \beta_r=0.1, \beta_t=0.05, v_{p_1}=v_{s_1}=v_{s_2}=5)$$

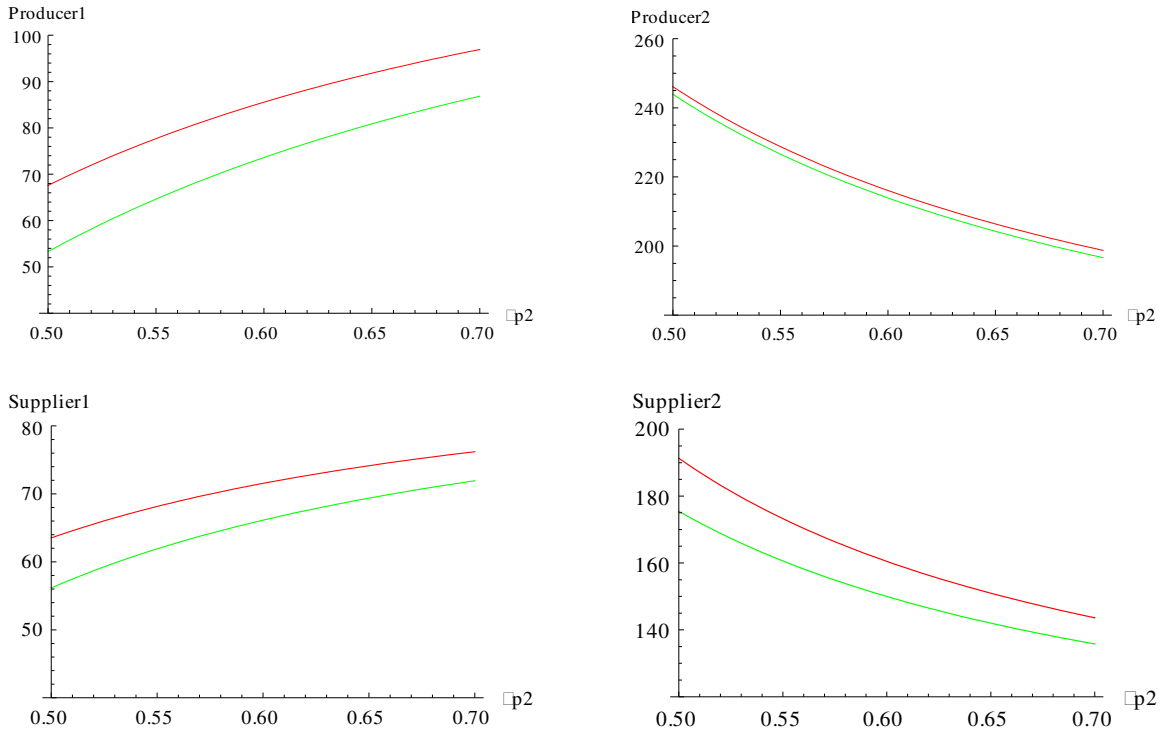

Figure 4.3.3.3:
First Scenario: Two Suppliers are located in Different Regions with $\gamma = 0.12$
(Black: Case 1 & Blue: Case 2)

$$(a=100, b=2, \bar{C}=20, \bar{P}=30, \beta_r=0.1, \beta_t=0.05, v_{p_1}=v_{s_1}=v_{s_2}=5)$$

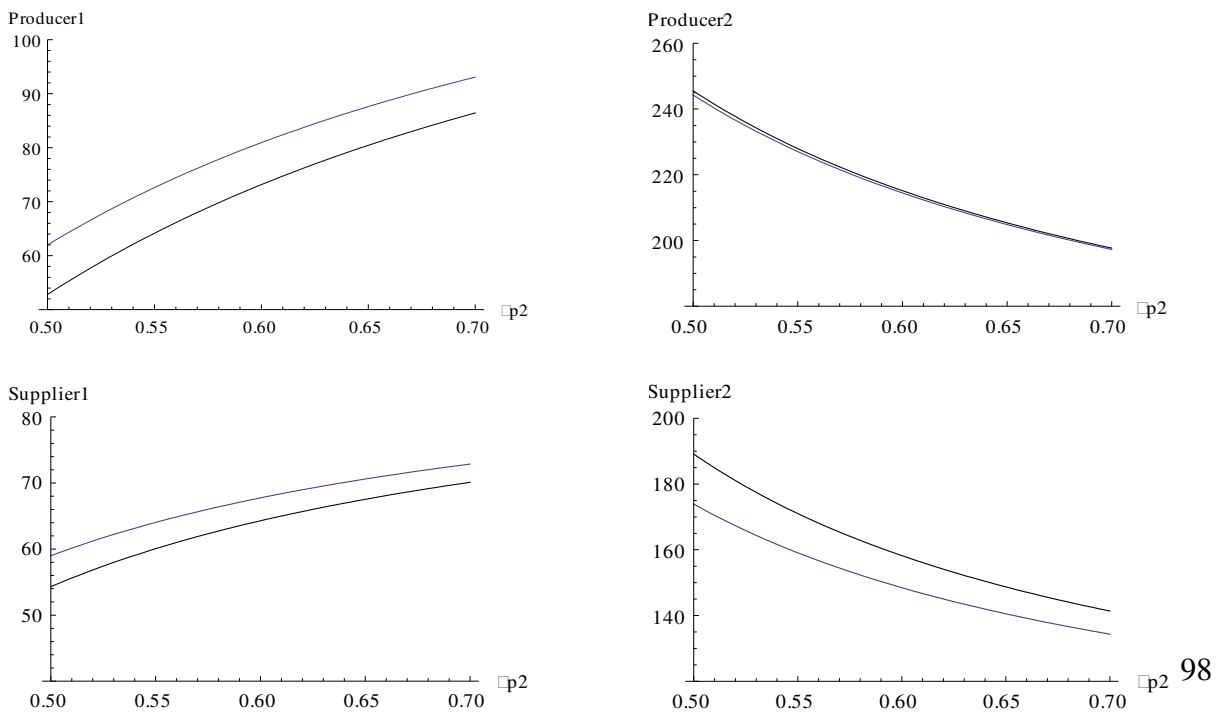
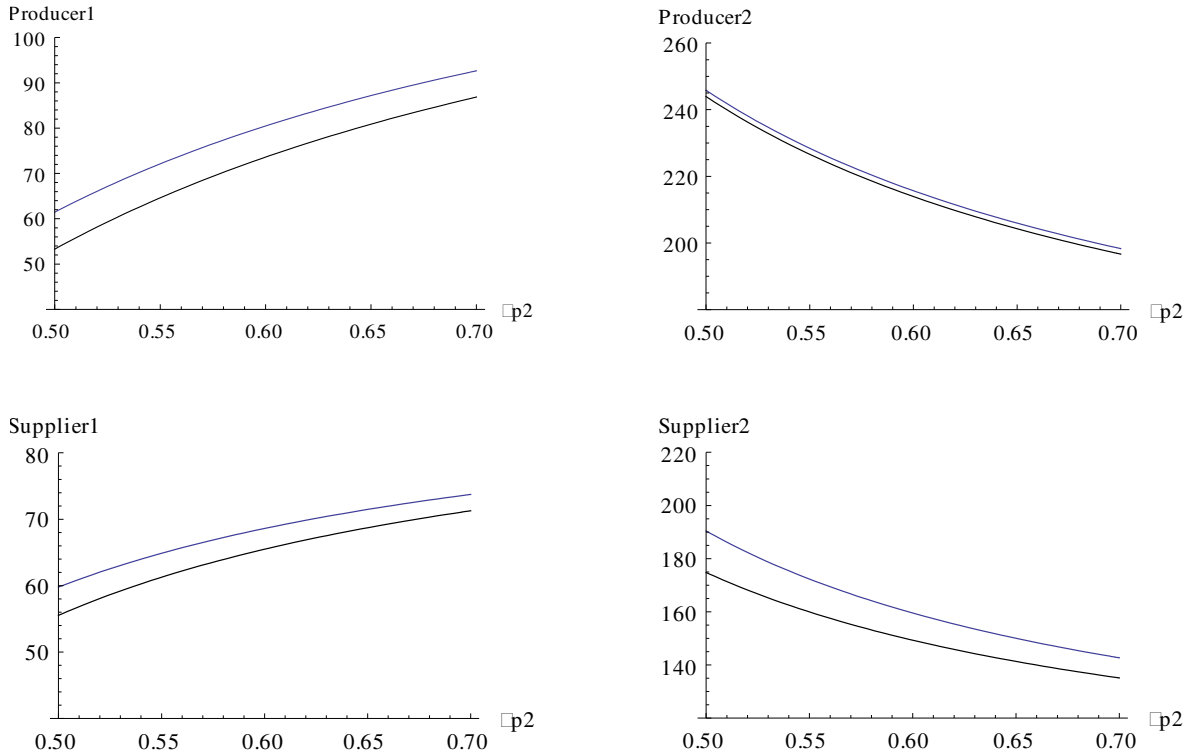

Figure 4.3.3.2.4:
Second Scenario: Two Suppliers are located in Same Region with $\gamma = 0.12$
(Black: Case 1 & Blue: Case 2)

$$(a=100, b=2, \bar{C}=20, \bar{P}=30, \beta_r=0.1, \beta_i=0.05, v_{r_1}=v_{s_1}=v_{s_2}=5)$$



5. Conclusion

Knowledge as a source of competitive advantage plays a vital role in nowadays business affairs such that in many cases affects the location decision of firms directly. Particularly, when we consider the location decision of innovative technology-based companies, the issue becomes more significant.

In this research we tried to answer the question that under which circumstances vertical knowledge spillover via supply chain lead us to geographical concentration which Porter (1998) named it cluster.

For this purpose a three-stage game theoretic model based on the inspiration of existing model in the literature of innovation, knowledge spillovers and economic geography has been established to empower us analyzing the subject more accurate. In our model we distinguished vertical knowledge spillover which occurs between a producer and its respected supplier from horizontal one happening between two firms of the same stream of the market. Moreover different technological level of our players was analyzed separately. Numerical approach with the utilization of Mathematica is applied to solve our strategic optimization problem.

Results show that based on the selected values of parameters, imposed assumptions, and designed scenarios, different location decision might be made in

Kashefi

which firms act within clusters or isolation. Observations 1-8 express the results which have been supported by graphs induced from our programming. Because of having reliability on our observations, broad ranges of parameters have been examined in order to guarantee the robustness of equilibrium outcomes.

A main limitation of this paper which leads the research to enter numerical analysis was the mathematically complicated nature of final equations. This made the comparison between different scenarios completely intractable. Another limitation was the number of scenarios that we have considered that is more probable scenarios could enrich the results.

Finally it might be useful to mention that different approaches can be applied to extend this work. Altering or relaxing each of our established assumptions in section 3 would open a new door, e.g. specific designed scenarios upon disposal of our supplier, assuming exogenous knowledge spillovers, can be developed. Moreover we have assumed that each producer is able just to provide his intermediate goods from his respected supplier and also each supplier can sell it only to his respected producer which would be an appropriate aspect of extension.

References

- Alcacer, J & Chung, W 2007, 'Location Strategies and Knowledge Spillovers', *Management Science*, vol. 53, no. 5, pp. 760-776.
- Audretsch, D & Feldman, M 2004, 'Knowledge Spillovers and Geography of Innovation', in JV Henderson & JF Thisse (eds.), *Handbook of Regional and Urban Economics*, vol. 4, North-Holland Press, Amsterdam, pp. 2714-2739.
- Almazan, A, De Motta, A & Titman, S 2007, 'Firm Location and the Creation and Utilization of Human Capital', *Review of Economic Studies*, vol. 74, pp. 1305-1327.
- Baldwin, RE & Martin, PH 2004, 'Agglomeration and Regional Growth', in JV Henderson & JF Thisse (eds.), *Handbook of Regional and Urban Economics*, vol. 4, North-Holland Press, Amsterdam, pp. 2671-2711.
- Belderbos, R, Lykogianni, E & Veugelers, R 2008, 'Strategic R&D Location by Multinational Firms: Spillovers, Technology Sourcing, and Competition', *Journal of Economics and Management Strategy*, vol. 17, no. 3, pp. 759-779.
- Beugelsdijk, S, Smeets, R & Zwinkels, R 2008, 'The Impact of Horizontal and Vertical FDI on Host's Country Economic Growth', *International Business review*, vol. 17, pp. 452-472.
- Cantwell, J 2009, 'Location and the Multinational Enterprise', *Journal of International Business Studies*, vol. 40, pp. 35-41.
- D'aspremont, C & Jacquemin, A 1988, 'Cooperative and Noncooperative R&D in Duopoly with Spillovers', *American Economic Review*, vol. 78, no. 5, pp. 1133-1137.
- Dawid, H, Greiner, A & Zou, B 2010, 'Optimal Foreign Investment Dynamics in the Presence of Technological Spillovers', *Journal of Economic Dynamics and Control*, vol. 34, no. 3, pp. 296-313.
- Dawid, H & Wersching, K 2007, 'On Technological Specialization in Industrial Clusters', in JP Rennard (ed.), *Handbook of Research on Nature-Inspired Computing for Economic and Management*, vol. 1, Idea Group, London, pp. 367-378.

Kashefi

- Feinberg, SE & Gupta, AK 2004, 'Knowledge Spillovers and the Assignment of R&D Responsibilities to Foreign Subsidiaries', *Strategic Management Journal*, vol. 25, pp. 823-845.
- Fujita, M & Thisse, JF 2009, 'New Economic Geography: An Appraisal on the Occasion of Paul Krugman's 2008 Nobel Prize in Economic Sciences', *Regional Science and Urban Economics*, vol. 39, pp. 109-119.
- Gersbach, H & Schmutzler, A 2003, 'Endogenous Spillovers and Incentives to Innovate', *Economic Theory*, vol. 21, pp. 59-79.
- Ishii, A 2004, 'Cooperative R&D Between Vertically Related Firms with spillovers', *International Journal of Industrial Organization*, vol. 22, pp. 1213-1235.
- Krugman, P 1991a, *Geography and Trade*, MIT Press, Cambridge.
- Krugman, P 1991b, 'Increasing Returns and Economic Geography', *Journal of Political Economy*, vol. 99, pp. 483-499.
- Krugman, P & Venables, AJ 1995, 'Globalization and the Inequality of Nations', *The Quarterly Journal of Economics*, vol. 110, no. 4, pp. 857-880.
- Matouschek, N & Robert-Nicoud, F 2005, 'The Role of Human Capital Investment in the Location Decision of Firms', *Regional Science and Urban Economics*, vol. 35, pp. 570-583.
- Porter, ME 1998, 'Clusters and the New Economics of Competition', *Harvard Business Review*, vol. 76, no. 6, pp. 77-90.
- Porter, ME & Stern, S 2001, 'Innovation: Location Matters', *MIT Sloan Management Review*, vol. 42, no. 42, pp. 27-37.
- Poyago-Theotoky, J 1999, 'A Note on Endogenous Spillovers in a Non-Tournament R&D Duopoly', *Review of Industrial Organization*, vol. 15, pp. 253-262.
- Riggs, W & Von Hippel, E 1994, 'Incentives to Innovate and the Sources of Innovation: The Case of Scientific Instruments', *Research Policy*, vol. 43, pp. 209-226.
- Shy, O 1995, *Industrial Organization*, MIT Press, Cambridge.
- Von Hippel, E 1998, *The Source of Innovation*, Oxford University Press, New York.