



Munich Personal RePEc Archive

**On the winning virtuous strategies for
ultra high frequency electronic trading in
foreign currencies exchange markets**

Ledenyov, Dimitri O. and Ledenyov, Viktor O.

James Cook University, Townsville, Australia

3 July 2014

Online at <https://mpra.ub.uni-muenchen.de/59770/>

MPRA Paper No. 59770, posted 09 Nov 2014 08:18 UTC

On the winning virtuous strategies for ultra high frequency electronic trading in foreign currencies exchange markets

Dimitri O. Ledenyov and Viktor O. Ledenyov

Abstract – In the Schumpeterian creative disruption age, the authors firmly believe that an increasing application of electronic technologies in the finances opens a big number of new unlimited opportunities toward a new era of the ultra high frequency electronic trading in the foreign currencies exchange markets in the conditions of the discrete information absorption processes in the diffusion - type financial systems with the induced nonlinearities. Going from the academic literature, we discuss the probability theory and the statistics theory applications to accurately characterize the trends in the foreign currencies exchange rates dynamics in the short and long time periods. We consider the financial analysis methods, including the macroeconomic analysis, market microstructure analysis and order flow analysis, to forecast the volatility in the foreign currencies exchange rates dynamics in the short and long time frames. We discuss the application of the Stratanovich-Kalman-Bucy filtering algorithm in the Stratanovich – Kalman – Bucy filter and the particle filter to accurately estimate the financial time series and predict the trends in the foreign currencies exchange rates dynamics in the time domain. We research the influence by the discrete information absorption on the ultra high frequency electronic trading strategies creation and execution during the electronic trading in the foreign currencies exchange markets. We formulate the Ledenyov law on the limiting frequency (the cut-off frequency) for the ultra high frequency electronic trading in the foreign currencies exchange markets.

JEL: G1, G10, G12, G14, G15, G20, C40, C42, C82, D0, D82, E42, F3, F4, F31 .

PACS numbers: 89.65.Gh, 89.65.-s, 89.75.Fb .

Keywords: absorption of information, diffusion of information, transmission of information, information theory, asymmetric information, ultra high frequency electronic trading, processing frequency, algorithmic trading, informed trading, noise trading, currencies exchange rate, vehicle currency, interest rate, retail aggregator, liquidity aggregator, interdealer trade orders flow direction, stop-loss order, bid - ask spreads, price discovery process, capital inflow, capital outflow, carry trade strategy, financial liquidity, foreign currencies exchange market micro structure, foreign currencies exchange rate dynamics, Wiener filtering theory, Stratanovich-Kalman-Bucy filtering algorithm, Stratanovich – Kalman – Bucy filter, particle filter, nonlinearities, artificial intelligence, Ledenyov law on limiting frequency for ultra high frequency electronic trading in foreign currencies exchange markets, econophysics, econometrics, global foreign exchange market, global capital market.

Introduction

Since the time, when the *first financial transactions* were completed in the *financial markets* in *Joseph Penso de la Vega* (1668, 1996), the investors have been thinking about the optimal solutions finding for the *complex investments decision making problems*, the *foreign currencies exchange rates estimation problems*, and the *financial risks assessment problems* in the *finances* in *Bernoulli* (1738, 1954), *Bagehot* (1873, 1897). The application of the *financial mathematics* in the *theory of value and prices* by *Fisher* (1892) led to more accurate assessment of various financial variables in the process of evolution of the *money market* in *Bagehot* (1873, 1897). The intensive development of the *probability theory* in the *mathematics* in *De Laplace* (1812), *Bunyakovsky* (1846), *Chebyshev* (1846, 1867, 1891), *Markov* (1890, 1899, 1900, 1906, 1907, 1908, 1910, 1911, 1912, 1913), encouraged the adaptation of more sophisticated mathematical techniques to evaluate the *financial risks*, forecast the *foreign currencies exchange rates* and predict the *returns-on-investments* in the *finances*, namely *Bachelier* (1900) proposed his original idea to estimate the *valuable financial papers prices evolution* with the help of the *probability theory* in the *mathematics*. The ingenious research ideas on the application of *probability theory* in *finances* have been further developed in *Slutsky* (1922a, b, 1925a, b, 1927a, 1937a, b). In addition, in the course of development of the *theory of financial speculations* in *Bachelier* (1900), it was understood that a possible characterization of the *complex financial systems* within the *financial markets* can be done much more accurately, considering the *existing theoretical models* in the *physics*, for example: the *model on the Brownian motion of molecules at the heat transfer process in the solids* in *Bunyakovsky* (1825) as well as the *Brownian movement of small particles suspended in a stationary liquid demanded by the molecular-kinetic theory of heat* in *Einstein* (1905, 1956), *Einstein, Smolukhovsky* (1936). Sometime later, the role of the *Brownian motion* in the *random processes* has been summarized in *Brush* (1968, 1977). Moreover, *Shiryayev, Grossinho, Oliveira, Esquível* (editors) (2006) write: “A.N. Kolmogorov, in his own landmark work *Über die analytischen Methoden in der Wahrscheinlichkeitsrechnung, Math. Annalen* 104 (1931), pp.415-458, credits *Bachelier* with the first systematic study of *stochastic processes in continuous time*.” The research propositions in *Bachelier* (1900) have been further developed in the *mathematical theory of the Wiener processes* in *Wiener* (1923, 1930, 1949). At later date, aiming to surpass the critical limitations of *classical theoretical models* like the *fractional Brownian motion*, the *multi-fractals* have been introduced in the *finances* from the *physics* in *Mandelbrot* (1960, 1963a, b, 1965, 1965, 1967a, b, 1969, 1971, 1972, 1975a, b, 1977, 1982, 1997), *Mandelbrot, Taylor* (1967), *Mandelbrot, van Ness* (1968),

Mandelbrot, Wallis (1969), Ausloos (2000), Kantelhardt, Zschiegner, Koscielny-Bunde, Havlin, Bunde, Stanley (2002), Norouzzadeh, Rahmani (2006), Kim, Yoon (2004), Jiang, Ma, Cai (2007), Jiang, Zhou (2009), Liu, Qian, Lu (2010), Wang, Yu, Suo (2012), Trenca, Plesoianu, Căpusan (2012). The intensive research on the application of the *Markov switching models* to forecast the *exchange rates fluctuations* has been conducted in Engel (1992), Dewachter (2001), Dueker, Neely (2005).

The formulation of both the *foreign exchange theory* in Machlup (1949), Robinson (1949) and the *theory of value* in Debreu (1959) in the frames of the *modern finances theory* in Bagehot (1873, 1897), von Böhm-Bawerk (1884, 1889, 1921), von Mises (1912) was a significant step forward in the *knowledge based society* in Hayek (1945). The new theories to forecast the *exchange rates trends behaviour* in the *foreign exchange markets* have been created in Machlup (1949), Robinson (1949), Friedman (editor) (1953), Brunner, Meltzer (editors) (1979), Allen, Kenen (1980), Loosignian (1981), Frankel (editor) (1983), Bigman, Taya (editors) (1983), Bilson, Marston (editors) (1984), Amihud, Ho, Schwartz (editors) (1985), Jones, Kenen (editors) (1985), Stoll (1985), Goodhart (1989), Miller, Eichengreen, Portes (editors) (1989), Courakis, Taylor (editors) (1990), Edwards (1991), Khonry (editor) (1991), Guillaume, Dacorogna, Dave, Muller, Olsen, Hamon, Jacquillat (1992), Frankel (editor) (1993), Amihud, Levich (editors) (1994), Bakker, Boot, Sleijpen, Vanthoor (editors) (1994), Brousseau, Czarnecki (1994), Almekinders (1995), Isard (1995), Grossman, Rogoff (editors) (1995), O'Hara (1995, 1998), Goodhart, Ito, Payne (1995, 1996), Frankel, Galli, Giovannini (editors) (1996), Rosenberg (1996), Campbell, Lo, MacKinlay (1997), Hartmann (1998), Lee (1998), Shiryayev (1998a), Helpman, Sadka (editors) (1998), Isard, Razin, Rose (editors) (1999), Collins, Rodrik (editors) (2001), Mark (2001), Bergsten, Williamson (2003, 2005), Mizen (editor) (2003), DeGrauwe (editor) (2005), Lyons (2006), De Grauwe, Grimaldi (2006), Acemoglu, Rogoff, Woodford (editors) (2008), Evans (2011), James, Marsh, Sarno (editors) (2012). In the *global monetary economics* in Claassen (1996), the *electronic trading in the foreign currencies exchange market* increases rapidly up to *US\$4 trillion* in 2010 in King, Rime (2010), King, Osler, Rime (2011), and it continues to evolve toward the introduction of the *high frequency electronic trading* in the *foreign currencies exchange market* in Goodhart (1992), Goodhart, Hall, Henry, Pesaran (1993), Goodhart, O'Hara (1995), Goodhart, O'Hara (1997). Indeed, the *high frequency finance* in Dacorogna, Gencay, Mueller, Olsen, Pictet (2001) has reached a state, when the *global foreign exchange markets* are trading at *5.3 trillion US dollars* per day and the *global monetary base* is *6.6 trillion US dollars* in 2014 in Sheng (2014).

During the *capitalism evolution process* with the *continuous innovation* and the *creative disruption*, the *disruptive innovation* is frequently generated by the means of the *innovation breakthrough processes* in Schumpeter (1911, 1939, 1947). The multiple discoveries of the *innovative disruptive technological advancements* in the *information communication technologies* in Shannon (1948), Ledenyov D O, Ledenyov V O (2012e) have been introduced in the *Schumpeterian creative destruction age*, resulting in the appearance of the technological and scientific advancements toward the ***ultra high frequency electronic trading in the foreign currencies exchange markets***. In this empirical research article, we would like to discuss comprehensively the modern theories and practices toward the *ultra high frequency electronic trading in the foreign exchange markets* at an influence by the *discrete information absorption processes* in the *diffusion – type financial systems* with the *induced nonlinearities*, using the *econometrical* and *econophysical* principles, theories and perspectives in Schumpeter (1906, 1933), Bowley (1924), Box, Jenkins (1970), Grangel, Newbold (1977), Van Horne (1984), Taylor S (1986), Tong (1986, 1990), Judge, Hill, Griffiths, Lee, Lutkepol (1988), Hardle (1990), Grangel, Teräsvirta (1993), Pesaran, Potter (1993), Banerjee, Dolado, Galbraith, Hendry (1993), Hamilton (1994), Karatzas, Shreve (1995), Campbell, Lo, MacKinlay (1997), Rogers, Talay (1997), Hayashi (2000), Durbin, Koopman (2000, 2002, 2012), Ilinski (2001), Greene (2003), Koop (2003), Davidson, MacKinnon (2004), Campbell, Lo, MacKinlay (1996). In the conditions of the *highly volatile dynamics* of *global financial system* in Aliber (2002), we would like to focus specifically on the application of the *probability theory* in De Laplace (1812), Bunyakovsky (1846), Chebyshev (1846, 1867, 1891), Markov (1890, 1899, 1900, 1906, 1907, 1908, 1910, 1911, 1912, 1913), Kolmogorov (1938, 1985, 1986), Wiener (1949), Brush (1968, 1977), Shiryayev (1995), Ledenyov (2004) to analyze the *nonlinear financial systems dynamics*, aiming to predict the *trends* in the *foreign currencies exchange rates* at an influence by the *discrete information absorption processes* in the *diffusion – type financial systems* with the *induced nonlinearities*.

Researching the *international financial markets* in Grabbe (1991), we are particularly interested in the research results on the modern applications of the *optimal filtering and prediction algorithms* in the frames the *theory of optimal non-linear filtering of random functions* in Stratonovich (1959a, b, 1960 a, b), aiming to forecast the *foreign exchange rates* at the *ultra high frequency electronic trading in the foreign currencies exchange markets* at an influence by the *discrete information absorption processes* in the *diffusion – type financial systems* with the *induced nonlinearities*. The *Stratonovich – Kalman – Busy filtering algorithm* would be a main subject of our research interest, when attempting to solve the *foreign currencies*

exchange rates forecast problem in Bode, Shannon (1950), Zadeh, Ragazzini (1950), Booton (1952), Davis (1952), Bartlett (1954), Doob (1955), Franklin (1955), Laning, Battin (1956), Lees (1956), Solodovnikov, Batkov (1956), Pugachev (1956a, b), Newton, Gould, Kaiser (1957), Tukey (1957), Rytov (1957), Bellman, Glicksberg, Gross (1958), Blum (1958), Darlington (1958), Davenport, Root (1958), Sherman (1958), Shinbrot (1958), Smith (1958), Merriam (1959), Stratonovich (1959a, b, 1960 a, b), Kalman, Koepcke (1958), Kalman, Koepcke (1959), Kalman, Bertram (1958), Kalman, Bertram (1959), Kalman (1960a, b), Kalman, Bucy (1961), Kalman (1963), US Air Forces Office of Scientific Research (1960 – 2014), Wright-Patterson Air Forces Base (AFB) (1970 – 2014), Friedman (1962), Kushner (1967), Kushner, Budhiraja (2000), Bryson, Ho (1969), Jazwinski (1970), Sorenson (1970), Bucy, Joseph (1970), Chow, Lin (1971), Chow, Lin (1976), Maybeck (1972, 1990), Willner (1973), Leondes, Pearson (1973), Akaike (1974), Athans (1974), Dempster, Laird, Rubin (1977), Griffiths (1977), Schwarz (1978), Falconer, Ljung (1978), Anderson, Moore (1979), Bozic (1979), Julier, Uhlmann (1997), Priestley (1981), Geweke, Singleton (1981), Fernandez (1981), Meinhold, Singpurwalla (1983), Harvey, Pierse (1984), Harvey (1987, 1989), Lewis (1986), Watson (1986), Lanning (1986), Burrige, Wallis (1988), Proakis, Manolakis (1988), de Jong (1988, 1989, 1991), de Jong P, Chu-Chun-Lin (1994), de Jong, Penzer (2004), Franklin, Powell, Workman (1990), Brockwell, Davis (1991), Jang (1991), Doran (1992), Brown, Hwang (1992, 1997), Gordon, Salmond, Smith (1993), Tanizaki (1993), Pinheiro, Coimbra (1993), Bar-Shalom, Xiao-Rong Li (1993), Farhmeir, Tutz (1994), Grimble (1994), Bomhoff (1994), Lee, Ricker (1994), Ricker, Lee (1995), Kleeman (1995), Shiryayev (1995), Venegas, de Alba, Ordorica (1995), Golub, van Loan (1996), Hayes (1996), Haykin (1996), Fuller (1996), Roncalli (1996), Wells (1996), Hodrick, Prescott (1997), Krelle (1997), Babbs, Nowman (1999), Kim, Nelson (1999), Pitt, Shephard (1999), Wanhammar (1999), Durbin, Koopman (2000, 2002, 2012), Cuche, Hess (2000), Ito, Xiong (2000), Doucet, de Freitas, Gordon (2001), Haykin (editor) (2001), Welch, Bishop (2001), Arulampalam, Maskell, Gordon, Clapp (2002), Javaheri, Lautier, Galli (2002), Doucet, Tadic (2003), Bahmani, Brown (2004), Broto, Ruiz (2004), Ristic, Arulampalam, Gordon (2004), Cappé, Moulines (2005), Ozbek, Ozale (2005), Poyiadjis, Doucet, Singh (2005a, b), Proietti (2006), Litvin, Konrad, Karl (2003), van Willigenburg, De Koning (2004), Voss, Timmer, Kurths (2004), Cappé, Moulines, Rydén (2005), Fernández-Villaverde, Rubio-Ramirez (2005, 2007), Fernández-Villaverde (2010), Frühwirth-Schnatter (2006), Pasricha (2006), Misra, Enge (2006), Gamerman, Lopes (2006), Pasricha (2006), Rajamani (2007), Bignasca, Rossi (2007), Andreasen (2008), Olsson, Cappé, Douc, Moulines (2008), Roncalli, Weisang (2008), Rajamani, Rawlings (2009), Bationo, Hounkpodote (2009), Chang, Miller, Park (2009), Mapa, Sandoval,

Yap (2009), Winschel, Kratzig (2010), Francke, Koopman, de Vos (2010), Theoret, and Racicot (2010), Xia, Tong (2011), Jungbacker, Koopman, van der Wel (2011), Moghaddam, Haleh, Ebrahimijam (2011), Darvas, Varga (2012), Hang Qian (2012), Proietti, Luati (2012a, b), Creal (2012), Matisko, Havlena (2012), Wikipedia (2014), Ledenyov D O, Ledenyov V O (2013g, h). Pursuing these research goals, we will apply the *differential equations theory* in Gikhman, Skorohod (1968), Sharkovsky, Maistrenko, Romanenko (1986), Protter (2005) with the purpose to accurately characterize the *time-dependent random processes with the independent increments* in Skorohod (1967), Ledenyov V O, Ledenyov O P, Ledenyov D O (2002) during the *ultra high frequency electronic trading in the foreign currencies exchange markets* at an influence by the *discrete information absorption processes in the diffusion – type financial systems with the induced nonlinearities*.

Let us begin the innovative advanced research by making a short introductory review on the subject of our research interest, following by both the thoughtful consideration on the modern technological trends in the *ultra high frequency electronic trading in the foreign exchange markets*, and the discussion on the possible impacts by the *various information absorption processes on the ultra high frequency electronic trading strategy creation and execution in the foreign exchange markets* at an influence in the *diffusion – type financial systems with the induced nonlinearities*. We would like to note that some additional attention would also be paid to the innovative research proposals, regarding the possible improvement of the existing *electronic trading systems in the foreign exchange economics* in DeGrauwe (editor) (2005). Thus, we would like to move forward by providing a few concise definitions on the *electronic trading in the foreign exchange markets* by various authors, aiming to clarify the term's meaning from the scientific point of view.

Gençay, Gradojevic (2009) write: “The *FX market* can generally be described as decentralized and worldwide, but the actual trading is processed in the bookkeeping of particular markets, with the major ones being *London, New York* and *Tokyo*. Thus, the total trading activity of informed and uninformed traders is comprised of the geographic contributions of individual market centers. The hours of operation of the market centers are different, but they jointly contribute to the aggregate market trading activity. For instance, the *London Stock Exchange (LSE)* and the *New York Stock Exchange (NYSE)* are both open from 09:30 to 11:30 EST. In contrast, the lowest market presence outside weekends can be found during the lunch break at the *Tokyo Stock Exchange (TSE)*, when it is night in *North America* and *Europe*.”

Gallardo, Heath (2009) continue to explain: “The development of *electronic broking and trading systems* represents one of the most significant catalysts of structural change in *foreign exchange markets* over the past decade or so.”

Heath, Whitelaw (June 2011) state: “The introduction of *electronic broking* to the *foreign exchange market* in the early 1990s signaled the start of a process of innovation that has driven significant change.” Heath, Whitelaw (June 2011) continue to write: “*Electronic trading* has been a significant factor behind a number of changes in the structure of the *foreign exchange market* and the way the market operates. These developments include improvements in the price discovery process, a concentration of activity among a relatively small number of large global banks, a blurring of the traditional activities of different market participants, a marked increase in the activity of non-bank participants and the emergence of new market segments.”

The research article will cover the following research topics:

1. Introduction.
2. The discussion on the *probability theory* and the *statistics theory* to accurately characterize the trends in the *foreign currencies exchange rates dynamics* at the *electronic trading* in the *foreign currencies exchange markets* over a *selected time period*.
3. The discussion on the *financial analysis methods*, including the *macroeconomic analysis*, *market microstructure analysis* and *order flow analysis*, to forecast the *foreign currencies exchange rates dynamics* during the *electronic trading process* in the *foreign currencies exchange markets*.
4. The discussion on the application of the *Stratanovich-Kalman-Bucy filtering algorithm* in the *Stratanovich – Kalman – Bucy filter* and the *particle filter* to accurately estimate the *time series* and predict the *trends in the foreign currencies exchange rates dynamics* during the *electronic trading* in the *foreign currencies exchange markets*.
5. The discussion on the influence by *discrete information absorption* on the *ultra high frequency electronic trading strategies creation and execution* during the *electronic trading* in the *foreign currencies exchange markets* in the *diffusion - type financial system* with the *induced nonlinearities*.
6. The discussion on the *Ledenyov law* on the *limiting frequency* (cut off frequency) for the *ultra high frequency electronic trading* in the *foreign currencies exchange markets* in conditions of the *discrete information absorption processes* in the *diffusion - type financial systems* with the *induced nonlinearities*.
7. Concluding remarks.

Probability theory and statistics theory application to accurately characterize trends in foreign currencies exchange rates dynamics in foreign currencies exchange markets in short and long time periods

Let us begin our research on the various aspects of the *electronic trading* in the *foreign currencies exchange markets* at an influence by the *nonlinear information absorption, diffusion and transmission processes* by making a comprehensive historical overview on the subject of our research interest with a particular accent on the original contributions to the field of research.

In a *more safer and stable global financial system*, which is regulated by the *Basel III* agreement, in *Ingves, Danielsson, Goodhart (2014)*, the *authors* believe that the *electronic trading* in the *foreign currencies exchange market* creates the new opportunities and challenges, which must be accurately defined and comprehensively researched in the *finances*.

Yamaguchi (2001) states: “An *ET system* is a facility that provides some or all of the following services:

- 1) *electronic order routing* (the delivery of orders from users to the execution system),
- 2) *automated trade execution* (the transformation of orders into trades), and
- 3) *electronic dissemination of pre-trade* (bid/offer quotes and depth) and *post-trade information* (transaction price and volume data).”

Yamaguchi (2001) explains: “*Electronic systems* are currently used to varying degrees for trading in the markets for *foreign exchange* and fixed income. Penetration differs between markets, between market segments, between instruments, between types of trading and between the various stages of the trading process. Moreover, the situation is changing rapidly; a dominant system can give way to another in as quickly as a few months. The main impact of *ET* so far relates to the inter-dealer (voice) broker, who is increasingly being replaced by *electronic systems*. This does not necessarily imply that brokerage firms are going out of business as they may reinvent themselves by offering an electronic service. Furthermore, *electronic trading* makes the direct dealing relationships redundant, i.e. the interaction in the inter-dealer market is becoming increasingly multilateral.”

Fig. 1 shows the *interaction between the market participants prior to the electronic trading*, and Fig. 2 depicts the *interaction between the market participants after the introduction of electronic trading* in *Yamaguchi (2001)*.

Fig. 3 displays the evolution of *FX market structure* in *King, Osler, Rime (2011)*.

Interaction between market participants prior to electronic trading

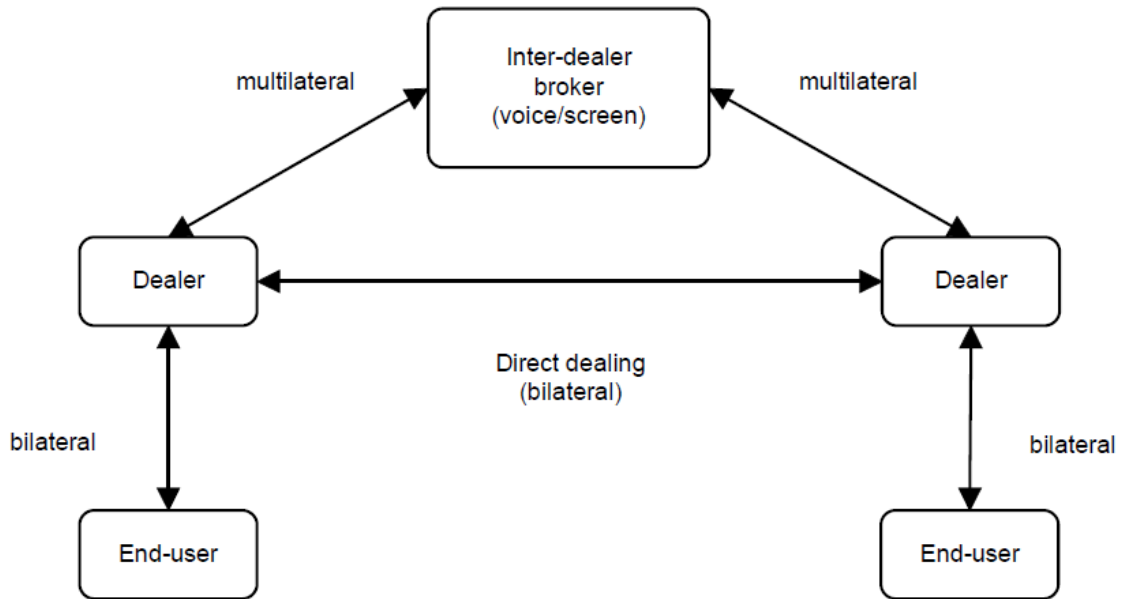

Fig. 1. Interaction between market participants prior to electronic trading (after Yamaguchi (2001)).

Interaction between market participants after the introduction of electronic trading

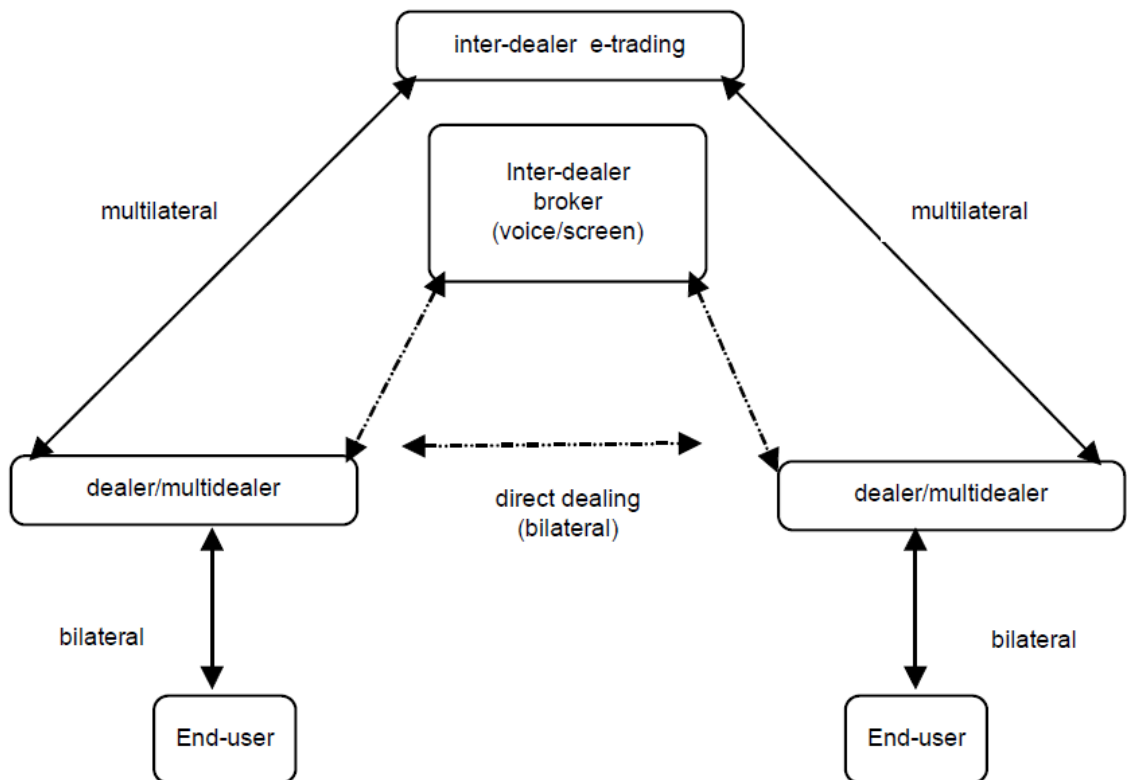

Fig. 2. Interaction between market participants after introduction of electronic trading (after Yamaguchi (2001)).

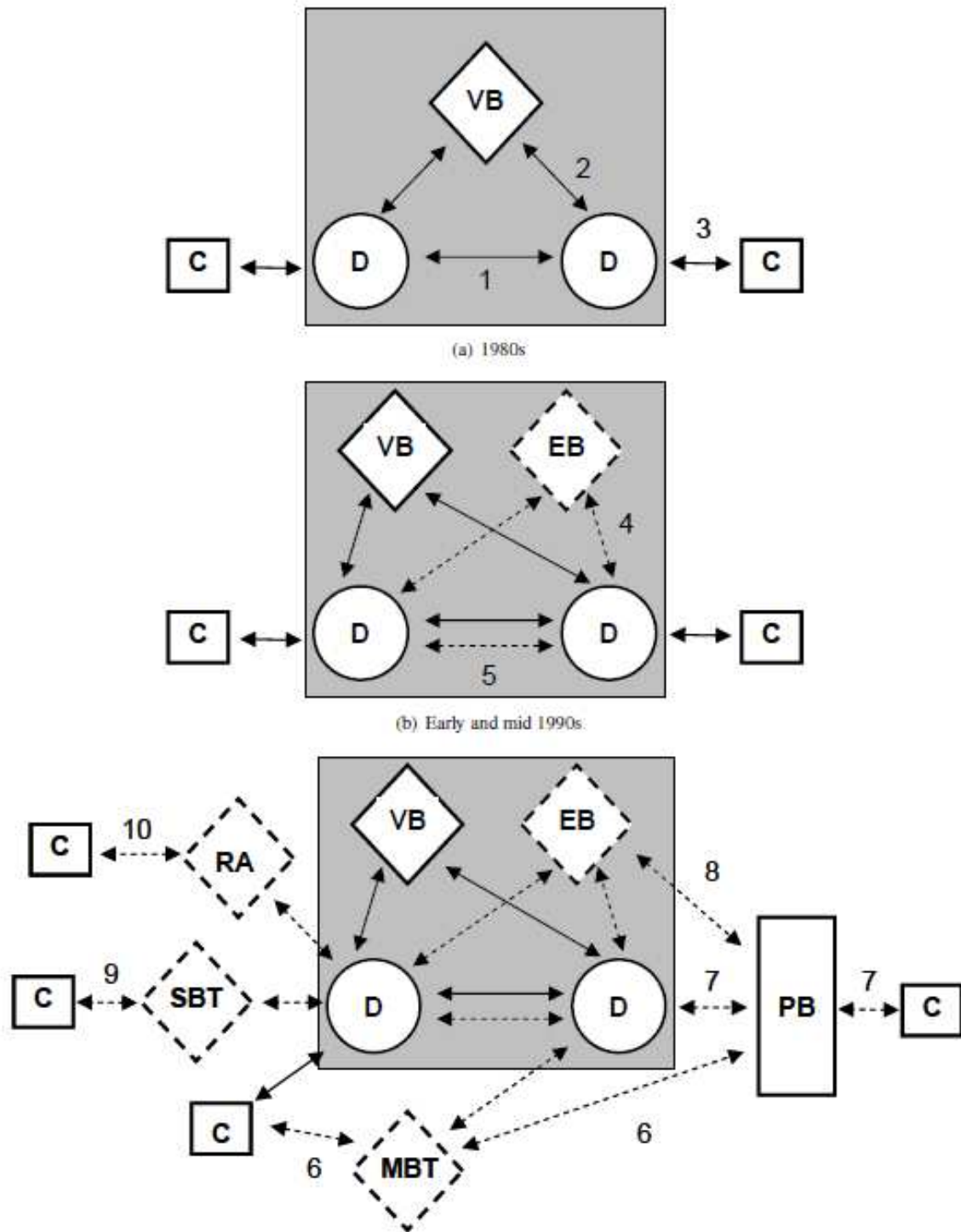

Fig. 3. Evolution of FX market structure: D=dealer, C=client, VB=voice broker, EB=electronic broker, PB=prime broker, MBT = multibank trading system, SBT=single-bank trading system, RA=retail aggregator. Solid lines represent voice execution methods. Dashed lines represent electronic execution methods (after King, Osler, Rime (2011)).

Stoll (2006) explains: “The idea of *electronic trading* is not new. In 1971, *Fischer Black* suggested steps toward a *fully automated exchange* that would eliminate the need for *specialists* and *market-makers*. He noted that “a stock exchange can be embodied in a network of computers, and the costs of trading can be sharply reduced, without introducing any additional instability in stock prices, and without being unfair either to small investors or large investors” *Black (1971, part II)*. He had in mind a world in which investors would interact with one another with little or no human intervention. That world is near, but *Fischer Black* (were he still alive) would be surprised at how long it has taken. The automation at *ECNs* has achieved what *Fischer Black* had in mind...”. *Stoll (2006)* lists the following *ECN* advantages: “*ECNs* have a number of advantages.

1) They are *automatic*. Once an order is submitted, trade execution proceeds without human intervention according to price/time priority, unlike traditional markets, where orders might be held by dealers.

2) They are *anonymous*. The identity of traders is not revealed, which can be of importance to certain traders.

3) They are *low cost*. *ECNs* earn income by charging a fee to market orders of about 3 cents per share, while they pay for orders that supply liquidity.

4) They are *fast*. Execution and confirmation are electronic and occur in less than a second.

5) They can be *programmed to offer complex orders*. For example, *ECNs* can offer contingent trades where the price is adjusted for changes in index prices or in the prices of other stocks.”

Gallardo, Heath (2009) write: “One of the most significant developments in the *foreign exchange market* over recent decades has been the introduction and growth of new *electronic trading technologies*. In addition to increasing the efficiency of *foreign exchange markets*, the diffusion of this technology has allowed new market segments to develop.” *Gallardo, Heath (2009)* continue to explain: “In 1989 *Reuters* began offering participants in the *interbank market* a so-called *electronic broking service*, whereby trading is carried out through a network of computer terminals linked among participating users, and new orders are matched with outstanding orders already in the system. In the early 1990s a consortium of banks launched *EBS* to provide a similar service. *Electronic broking* systems allow banks to make a “one-way” price quote and, in addition to the best bid and offer prices, display information about the closest bids and offers in the system. The resulting transparency of prices obviates the need to spend resources on price discovery activities, as interbank price quotes are now available at all times to

participating interbank dealers. Another important feature of these systems is that a large order can be matched with several small ones, which allows banks to make a one-way price quote for smaller amounts. Access to these systems therefore enabled smaller institutions to deal at more favourable spreads that had previously been available only to large institutions. *Reuters Matching* and *EBS* continue to dominate in the interdealer market, although they cover somewhat different currencies: while *Reuters Matching* specializes in major *Commonwealth currencies*, *EBS* has much more trading in the *US dollar, Euro, Yen* and *Swiss Franc*.”

Gallardo, Heath (2009) mention: “The downward trend in *bid-ask spreads* had leveled off by the *mid-2000s* but increased significantly following the failure of *Lehman Brothers* in *September 2008*. As volatility in foreign exchange markets spiked to nearly three times normal levels (*Reserve Bank of Australia (2009)*), *bid-ask spreads* for many major *currency pairs* more than doubled between *September* and *December* (Graph 1, left-hand panel),” as vividly demonstrated in Fig. 3. *Gallardo, Heath (2009)* note: “The high fixed costs of making the investment required to put in place and maintain the systems that can handle high volumes of transactions have been one of the factors behind the increased concentration of liquidity provision and market making in the interbank market (*ECB (2003)*; see also Graph 1, right-hand panel),” as presented in Fig. 3.

Characterizing the *interbank spot foreign exchange market* activity, *Gallardo, Heath (2009)* comment: “Turnover on *EBS* and *Reuters*, which grew rapidly over most of the past decade, also reversed course in late *2008* (Graph 2). Though activity in interbank markets in many *currency pairs* leveled off in *mid-2007*, growth resumed in some major *currency pairs*, such as the *euro/US dollar*, in *2008*. But in late *2008*, activity levels dropped sharply across the board: turnover for the three most traded *currency pairs* in *EBS* roughly halved between the end of *September* and the end of the year,” as shown in Fig. 4.

Fig. 4 presents the *bid-ask spreads* and the *foreign exchange market concentration*, and Fig. 5 shows the *interbank spot foreign exchange market* activity in *Gallardo, Heath (2009)*.

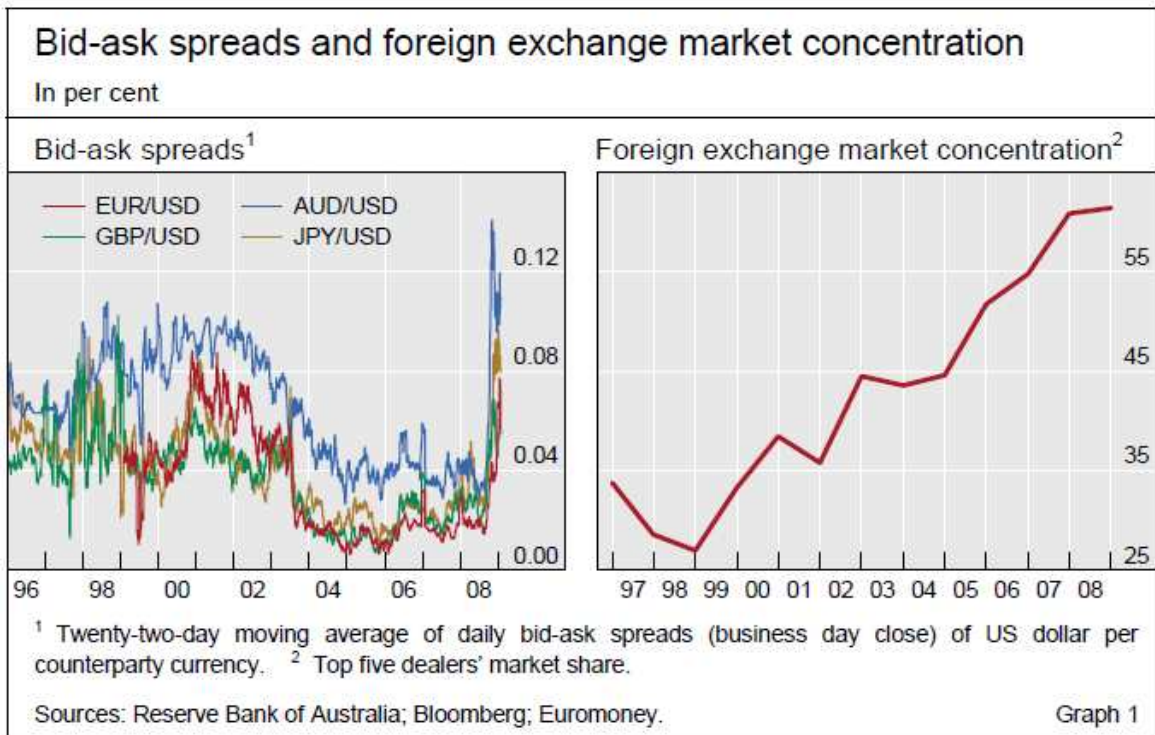

*Fig. 4. Bid-ask spreads and foreign exchange market concentration
(after Gallardo, Heath (2009)).*

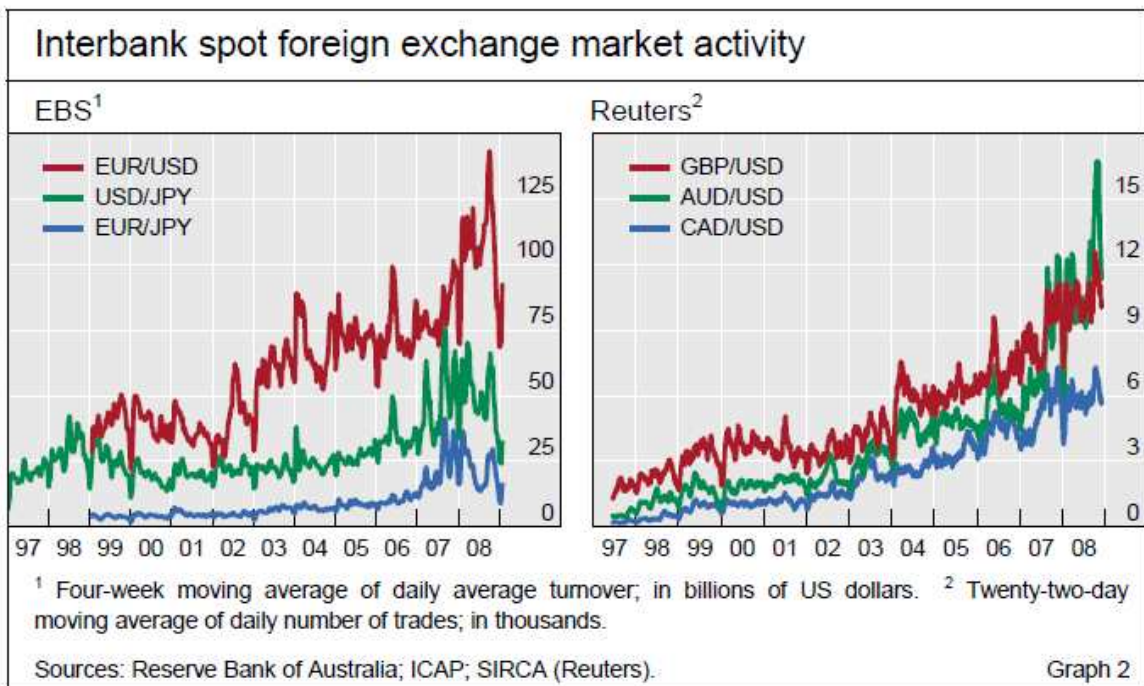

Fig. 5. Interbank spot foreign exchange market activity (after Gallardo, Heath (2009)).

Let us demonstrate that the rapid expansion of the *electronic trading* in the *foreign exchange markets* takes place in the *finances* in various countries, using the data analytics in *Gallardo, Heath (2009)*: “In total, around one third of all *foreign exchange transactions* are executed electronically. Disaggregating the triennial survey by transaction type shows that *electronic execution methods* are most prevalent in the spot market, accounting for over half of turnover on a global basis (Table 1). *Electronic broking systems*, such as *Reuters Matching* or *EBS*, account for around 32% of all spot market transactions, while single- and multibank electronic trading platforms represent 17% and 8%, respectively. Among non-electronic methods, the most important way of executing spot transactions is directly between banks and their customers (“customer direct”).” The foreign exchange market turnover by the execution method is shown in Tab. 1 in *Gallardo, Heath (2009)*.

Gallardo, Heath (2009) state: “*Electronic execution methods* are extensively used across all counterparties. Around 35% of interbank transactions are executed electronically, with almost two thirds of this accounted for by electronic broking systems (Table 2). Almost half of all interbank transactions occur directly between dealers (the category “inter-dealer direct”), and voice brokers execute the remainder.” The foreign exchange market turnover by counterparty is shown in Tab. 2 in *Gallardo, Heath (2009)*.

Gallardo, Heath (2009) write: “Given the relatively rapid growth in turnover between banks and other financial institutions as well as non-financial customers (*BIS (2007)*), and the importance of multibank and single-bank trading systems for these counterparty categories, these data suggest that turnover through these trading systems has increased significantly faster than that executed on electronic broking systems. Data from the *Foreign Exchange Committee* on foreign exchange turnover in the *United States*, which show that turnover through electronic trading systems (both multibank and single-bank) has grown at an exceptionally rapid pace, support this conjecture (Graph 3).” The *FX* turnover in the *United States* by execution method is presented in Fig. 6 in *Gallardo, Heath (2009)*.

Gallardo, Heath (2009) explain: “The importance of *electronic execution* in *foreign exchange markets* across different economies varies widely (Table 3). In a number of cases, the share of electronic methods is consistently high (or low) across all instruments and counterparties. For example, it is consistently high across all market segments for *Switzerland* and *Germany*, but consistently low for *Denmark*, *Latin America* and smaller financial centres in *Asia*.” The global *foreign exchange market* turnover by *execution method* is shown in Tab. 3 in *Gallardo, Heath (2009)*.

Foreign exchange market turnover by execution method ¹							
Daily averages in April 2007, percentage share by transaction type							
	Inter-dealer direct	Voice broker	Customer direct	Electronic methods			Total
				Broking systems	Multibank trading systems	Single-bank trading systems	
Spot transactions	13	2	28	32	8	17	57
Outright forwards	17	8	45	7	11	12	30
FX swaps	22	27	25	13	6	6	25
OTC FX options	26	16	51	4	2	2	8
Total	19	17	30	17	7	10	34

¹ Adjusted for local and cross-border inter-dealer double-counting, "net-net".
Source: BIS Triennial Survey. Table 1

Tab. 1. Foreign exchange market turnover by execution method (after Gallardo, Heath (2009)).

Foreign exchange market turnover by counterparty ¹							
Daily averages in April 2007, percentage share by counterparty							
	Inter-dealer direct	Voice broker	Customer direct	Electronic methods			Total
				Broking systems	Multibank trading systems	Single-bank trading systems	
Reporting dealers (interbank)	45	20	–	23	5	7	35
Other financial institutions (non-bank)	–	18	48	15	8	11	34
Non-financial customers	–	7	62	9	8	14	31
Total	19	17	30	17	7	10	34

¹ Adjusted for local and cross-border inter-dealer double-counting, "net-net".
Source: BIS Triennial Survey. Table 2

Tab. 2. Foreign exchange market turnover by counterparty (after Gallardo, Heath (2009)).

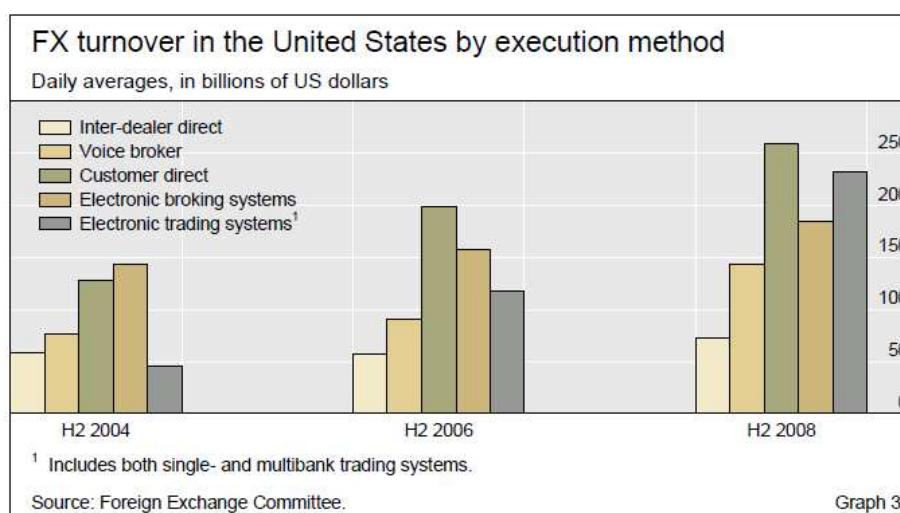

Fig. 6. FX turnover in the United States by execution method after Gallardo, Heath (2009)).

Global foreign exchange market turnover by execution method ¹					
Daily averages in April 2007, percentage share by location					
	Inter-dealer direct	Voice	Customer direct	Electronic methods	Economy share ²
United Kingdom	22.9	18.8	27.9	30.4	34.1
United States	12.2	15.7	31.9	40.2	16.6
Switzerland	8.9	22.4	14.5	54.2	6.1
Japan	31.5	18.8	17.4	32.3	6.0
Singapore	34.4	17.5	12.4	35.6	5.8
Hong Kong SAR	45.5	19.5	9.9	25.0	4.4
Australia	33.0	20.2	15.2	31.6	4.3
France	16.6	33.3	16.7	33.4	3.0
Germany	22.6	2.2	12.4	63.7	2.5
Denmark	67.2	1.4	17.2	14.1	2.2
Canada	29.2	11.3	26.7	32.8	1.5
Russia	28.1	9.5	27.6	34.8	1.3
Other industrialised ^{3, 4}	35.0	8.4	22.2	34.4	6.7
Other Asia ^{3, 5}	29.8	17.2	26.2	26.8	2.4
Latin America ^{3, 6}	24.3	14.3	36.7	24.7	0.6
Central and eastern Europe ^{3, 7}	40.7	6.9	25.0	27.5	0.8
Other ^{3, 8}	32.1	5.4	18.6	43.8	0.5
Average ³	32.8	11.5	23.8	31.8	–
Aggregate	19.1	16.7	30.2	34.0	–

¹ Adjusted for local double-counting, "net-gross". ² Total country turnover as a share of global turnover. ³ Average of component shares. ⁴ Austria, Belgium, Finland, Greece, Ireland, Italy, Luxembourg, the Netherlands, New Zealand, Norway, Portugal, Spain and Sweden. ⁵ Chinese Taipei, India, Indonesia, Korea, Malaysia, the Philippines and Thailand. ⁶ Brazil, Chile, Colombia, Mexico and Peru. ⁷ Bulgaria, the Czech Republic, Estonia, Hungary, Latvia, Lithuania, Poland, Romania, Slovenia and Turkey. ⁸ Bahrain, Saudi Arabia and South Africa.

Source: BIS Triennial Survey. Table 3

Tab. 3. *Global foreign exchange market turnover by execution method*
(after Gallardo, Heath (2009)).

Gençay, Gradojevic (2009) conclude with a comment: “EBS operates as an *electronic limit order book* and is used for global interdealer spot trading. It is dominant for the *EUR-USD* and *USD-JPY* currency trading, while the *GBP-USD* currency pair is traded primarily on *Reuters Chaboud et al* (2008). The average daily *EUR-USD* trading volume (in *USD*) on *EBS* in 2003 was between 50-70 billion dollars, which is well above that of the *NYSE* (40 billion dollars).”

Heath, Whitelaw (June 2011) make the following statements: “*Electronic trading* in the *foreign exchange market* effectively began in the interdealer market with the introduction of *electronic broking systems* provided by *Reuters* (in 1992) and *EBS* (in 1993). Demand for these services came from institutions participating in the interdealer market looking for efficiency gains they were already realizing from electronic trading in other markets, in particular the equity market. The *electronic broking systems* offered by *Reuters* and *EBS* largely replicated the role played by the existing brokers (now differentiated by the term ‘voice brokers’) but provided an enhanced service. The platforms displayed, in real time, the best bid and offer as well as the

depth of the market, based on the orders posted by participating banks. As each bank entered counterparty credit limits into the systems prior to trading, the post-trade credit problem encountered when using the voice brokers was eliminated. The two broking systems greatly improved transparency of the price discovery process thereby facilitating more efficient offsetting of net foreign currency positions in the interdealer market.”

Heath, Whitelaw (June 2011) describe the advantages of *electronic trading* in Figs. 7 - 10: “The increased penetration of *electronic trading* in the *foreign exchange market* has led, directly or indirectly, to several important changes in the way the market is structured and operates:

1. *The increased efficiency and transparency of price discovery delivered initially by the electronic broking systems and then by the single-bank and multi-bank trading platforms have driven a marked decline in transaction costs, as measured by the difference between the price at which participants can buy and sell a currency at a point in time, known as the bid-ask spread* (Fig. 7).

2. *Price discovery now takes place across multiple venues, a development sometimes described as ‘liquidity fragmentation’.* In a margin trading model, the retail investor places a deposit with the broker in a margin account. The broker lends additional funds to the investor against the security of the funds in the margin account. The investor can then establish positions in the *foreign exchange market* up to the sum of their own funds and the funds provided by the broker. If the investor’s position sustains revaluation losses, these will be set off against the funds in the margin account and the investor will be required to deposit additional funds. The broker protects its exposure to the investor by ensuring the position is unwound prior to the loss exceeding the margin account balance. Fragmentation could make price discovery less efficient. However, market participants can now aggregate real-time price streams from multiple venues and execute on any one of them, effectively treating multiple markets as one. Some have also argued that the ability to post prices for a single trade across multiple venues creates the perception of greater market liquidity than is actually available. The implications of this ‘liquidity mirage’ are not entirely clear.

3. *There has been a marked increase in the concentration of foreign exchange activity across the books of a relatively small number of large global banks* in Fig. 8 in *Gallardo and Heath (2009)*. This reflects, to a large extent, the impact of the single-bank platforms on the distribution of *foreign exchange business*. It is notable that the most recent surveys of market concentration indicate a modest decline in concentration as other global banks look to emulate the success of the early movers using this model *Euromoney (2011)*.

4. Increasingly, banks are sourcing foreign currency liquidity for their customers from the large global banks. In some cases, this can involve an arrangement known as *white labeling*, where a bank provides streaming prices to its customer through a proprietary electronic interface. The streaming prices appear to be from the customer's bank but are, in fact, being provided directly but anonymously by another bank. In other cases, banks have become customers of the global banks for some foreign currency liquidity, particularly in the major currency pairs, but they continue to provide liquidity directly to their customers and to other banks, including the global banks, in their domestic currencies.

5. There has been some breakdown in the distinction between the traditional interdealer and customer markets. With direct electronic access and, where required, prime broker sponsorship, some non-banks can now directly access pricing and liquidity that was traditionally only available to banks. In addition, there has been some blurring between the roles of banks and their customers. As noted, many banks now participate in the foreign exchange market as customers of the largest banks while some non-banks now post bids and offers on electronic platforms, effectively competing with banks as market makers.

6. There has been a significant increase in the volume of foreign exchange business undertaken by dealers with their customers, which include other financial institutions, such as hedge funds, and non-financial institutions (Fig. 9, left panel). Greater access to both single-bank and multi-bank platforms, broader support from prime brokers and reduced transaction costs are among the factors behind this trend. The increase in the volume of customer business is also reflected in a rise in the share of total *foreign exchange activity* globally that is executed by dealers with their customers (Fig. 10, right panel). However, this increase also reflects the increasing internalization of customer business by the large dealers; a given volume of customer business will now lead to less activity between dealers than it would have 10 years ago.

7. Electronic trading has also enabled new customer market segments to develop. As noted earlier, retail investors have become an increasingly important part of the market. This is particularly true in *Japan* where retail margin trading has generated large enough foreign exchange flows to help explain developments in specific exchange rate pairs *Terada, Higashio and Iwasaki (2008); D'Arcy and Zurawski (2009)*. More recently, attention has increasingly focused on the role of high-frequency traders, for whom the ability to trade electronically is a precondition. Although the development of high-frequency trading was noted as an important new market segment before 2007 *Galati and Heath (2007)*, there appears to have been particularly strong growth in this market segment between 2007 and 2010 *Nightingale et al (2010); King and Rime (2010)*.

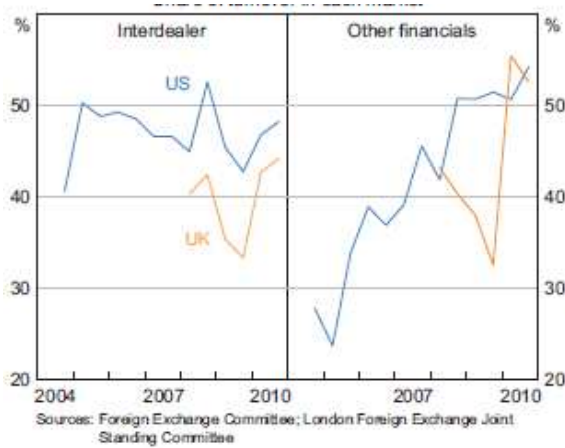

Fig. 7. Electronic execution: Share of turnover in each market (after Heath, Whitelaw (2011)).

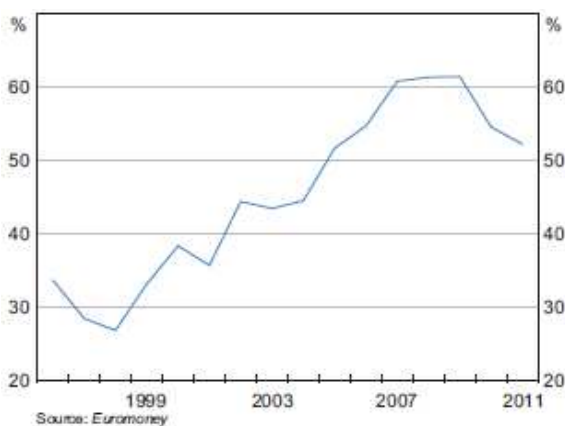

Fig. 9. Foreign exchange market concentration: Top five dealers' market share (after Heath, Whitelaw (2011)).

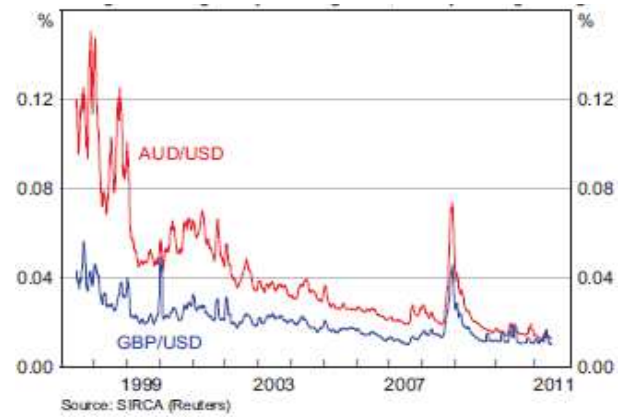

Fig. 8. Average daily bid-ask spreads: Percentage of average daily exchange rate, 22-day moving averages (after Heath, Whitelaw (2011)).

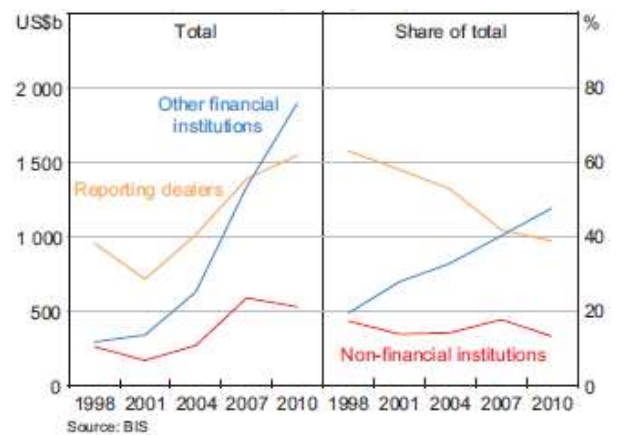

Fig. 10. Global foreign exchange turnover: By counterparty, average daily turnover (after Heath, Whitelaw (2011)).

Heath, Whitelaw (June 2011) summarize their most important research findings on the *electronic trading* by saying that: “Developments in *electronic trading* technologies over the past two decades have been an important driver of change in the *global foreign exchange market*. For banks, three key developments have been

- 1) a marked increase in the concentration of foreign exchange activity,
- 2) a change in the relationship between banks in the interdealer market, and
- 3) a significant increase in the volume and share of business conducted with non-bank customers.”

King, Osler, Rime (2012) describe the *electronic trading evolution*: “When introduced on FX trading floors in the late 1980s, Thomson Reuters Dealing replaced the telephone with an electronic system for dealers to exchange messages, allowing for speedier and more efficient interdealer trading. The more important change occurred in the early 1990s when Reuters

introduced the *first electronic limit-order market* for *FX*, now known as *Thomson Reuters Matching*, while a consortium of dealers launched a competing platform, *Electronic Broking Service (EBS)*. These systems revolutionized the interdealer segment, but remained inaccessible to end-customers. The landscape changed dramatically in the *late-1990s*, however, when a number of multibank trading platforms were launched that targeted end-customers directly. These systems enhanced transparency, improved operating efficiency, and reduced trading costs at the expense of greater concentration among the top dealers who streamed quotes to these platforms. Over the next decade, massive investments in the *IT* infrastructure by dealers and market participants opened the door to *algorithmic trading*, with *hedge funds* and *high-frequency traders* gaining direct access to interdealer markets from 2005 onwards *King and Rime (2010)*. Starting in the early 2000s, the top banks launched *proprietary single-bank trading platforms* for their customers, allowing them to create pools of liquidity that are not visible to the market.”

King, Osler, Rime (2012) write: “*Electronic trading* has enabled individuals of modest wealth, previously shut out of the market, to trade speculatively for their own account. This trading generally takes place over a new type of *electronic trading platform* known as the *retail aggregator*. By bundling many small retail trades into trades that meet the minimum \$1 million size for *interdealer trades*, *retail aggregators* can provide narrow spreads on even tiny trades. Retail trading has grown rapidly and was estimated to have reached \$125–150 billion per day by 2010, or 8 to 10 percent of the market *King and Rime (2010)*. Since retail *customer order flow* is generally uninformed *Heimer and Simon (2011)*, these customers are a profitable group to serve. Currently there is fierce competition for such business among the large banks, since they can effectively use these traders to provide liquidity for more informed customers. Evidence on *retail trading* remains quite limited, and represents a potentially fruitful area for future research.”

Discussing the *short-run exchange-rate dynamics*, *King, Osler, Rime (2012)* explain: “It is now recognized that currency traders hold heterogeneous beliefs and have access to different information, some of which is *private*. While financial customers appear to be the best informed, their trades have only a transitory impact. Corporations are typically less informed, provide liquidity in overnight markets, and may contribute to the persistent impact of *order flow* on *exchange rates*. *This interaction between informed and uninformed agents is key to modeling short-run exchange-rate dynamics.*”

Fig. 11 shows the average daily interdealer trading activity by the hour across the different currencies in *King, Osler, Rime (2012)*.

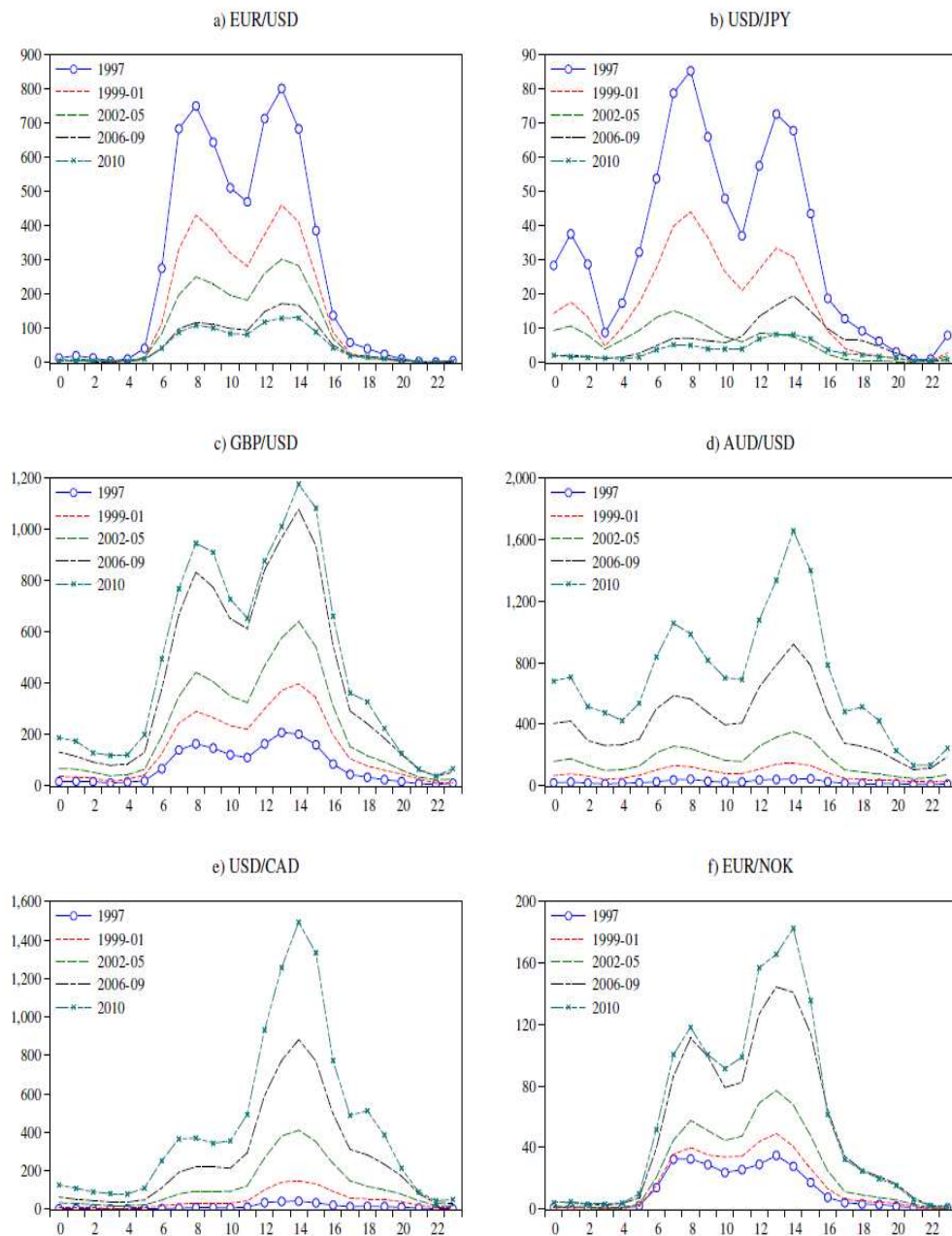

Note: The horizontal axis shows hour of day (GMT), and the vertical axis shows the average number of trades. The five lines are for 1997, the three 4-year average for 1998-01, 2002-05, and 2006-09, respectively, and finally for 2010. From e.g. GBP/USD (figure c) we see the growth in number of trades since 1997. The exchange rates EUR/USD and USD/JPY are now primarily traded on the competing platform EBS, hence the decrease in number of trades from 1997 to 2010 for these two exchange rates. Source: Thomson Reuters Matching.

Fig. 11. Average daily interdealer trading activity by the hour across different currencies (after King, Osler, Rime (2012)).

Maurer, Schäfer (2010) take a one step further and provide a definition of the **algorithmic trading**: “Algorithmic trading covers all trading activities where a computer algorithm autonomously decides on certain characteristics of an order. These characteristics

include but are not limited to the *instrument(s) to be traded, order limit, order volume, timing of order insertion, and choice of execution venue*. However, an *algorithm* does not need to decide on *all* of these characteristics in order to represent *algorithmic trading*. **Key to algorithmic trading, however, is the usage of strategies implemented on computer systems and the fact that the computer represents a driving element in order placement.**

The above definition encompasses – but is not limited to – the following practices:

- 1) Automated identification of investment opportunities (e.g. through statistical arbitrage);
- 2) Activities targeting optimal placement of orders created outside of the algorithm, e.g. placed with the trading desk by an external customer, with respect to time and order volume (e.g. volume weighted average-strategies);
- 3) Deciding optimal order placement with respect to execution venue taking into account potential execution price including implicit and explicit transaction costs (smart order routing).”

King, Osler, Rime (2011) suggest the following definition: “Algorithmic trading is a form of *electronic trading* where a computer algorithm (or program) determines an order-submission strategy and executes trades without human intervention Chaboud, Chiquoine, Hjalmarsson and Vega (2009). Human involvement is limited to designing the *algorithm* (or *algo*), monitoring it, and occasionally adjusting the trading parameters. Some *algos* simply automate existing strategies – for example, they break up large trades to minimize transaction costs – while others take advantage of superior execution speeds such as high-frequency trading.” The share of the algorithmic trading increases exponentially in Fig. 12 in King, Osler, Rime (2011).

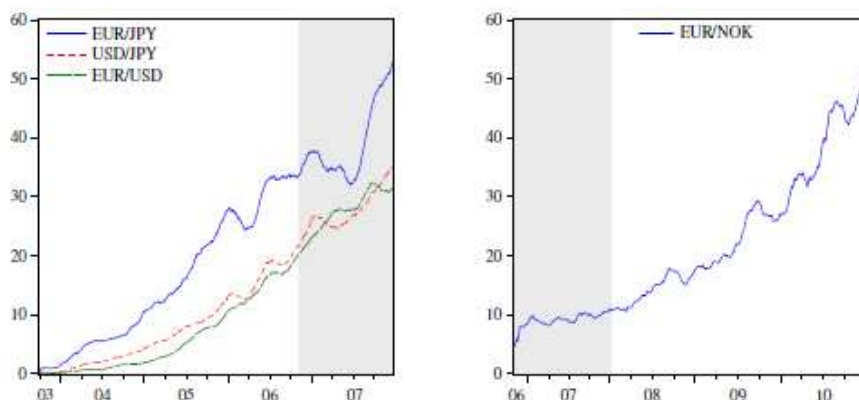

Fig. 12. Share of algorithmic trading on EBS and Thomson Reuters Dealing. Moving-average of share of trades involving at least one machine using gross volumes. Panel a: Fifty-day moving average of machine share on EBS for EUR/USD, USD/JPY and EUR/JPY. Source: Chaboud et al. (2009). Panel b: 7-week moving average of machine-share on Reuters D3000 for EUR/NOK.

The shaded area marks where the two graphs have overlapping observations.

(after King, Osler, Rime (2011)).

Let us point out to the fact that *Hong Kong* has a *well developed stable financial market* in *Lo (2000)*. *Yiu, Ho, Ma, Tsang (2010)* wrote an article, explaining that the **exchange rates and the economic fundamentals are interconnected nonlinearly**. *Yiu, Ho, Ma, Tsang (2010)* write: “The modified [target zone] model allows non-trivial portfolio choices between risk-free monetary assets and risky equities. In the model, the *Hong Kong-dollar exchange rate* movements depend on both the changes in the expected equity-return differential between *Hong Kong* and the *US* (i.e. the equity fundamental) and in the monetary fundamental. The typical **S-shaped relationship** between the *exchange rate* and the *economic fundamentals* in a *target zone model* becomes steeper taking into consideration the equity fundamental. In other words, the exchange-rate dynamics are more sensitive to the underlying movements of the fundamentals than implied by the conventional target zone models.”

The interest rates differential can be written as in *Yiu, Ho, Ma, Tsang (2010)*

$$\frac{1 + i_{t,m}^{HKD}}{1 + i_{t,m}^{USD}} = \frac{E[S_t^{t+m}]}{S_t},$$

where $i_{t,m}$ stands for *LIBOR* or *HIBOR* with a maturity of m months, E is the expectation of the m -month forward exchange rate; S is the spot exchange rate.

Fig. 13 shows the *Hong Kong-dollar exchange rate* in *Yiu, Ho, Ma, Tsang (2010)*.

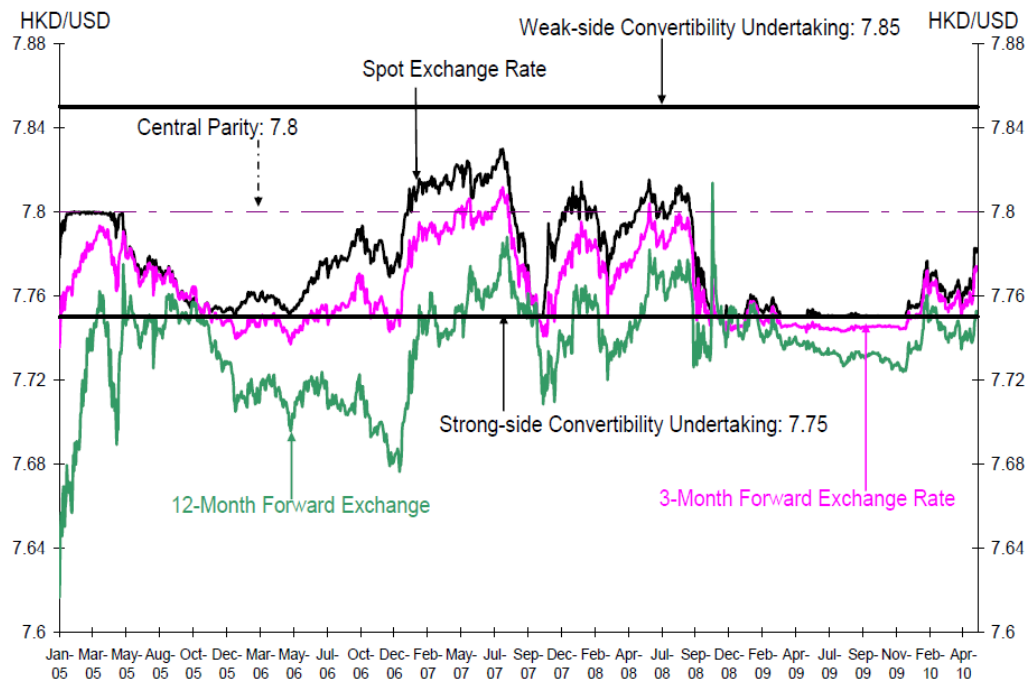

Fig. 13. *Hong Kong-dollar exchange rate (after Yiu, Ho, Ma, Tsang (2010)).*

Fig. 14 shows the *S-shaped* relationship between the *Hong Kong-dollar* exchange rate and the monetary fundamental; Fig. 15 depicts the tilted *S-shaped* relationship at the different correlations between the monetary and the equity fundamentals in *Yiu, Ho, Ma, Tsang (2010)*.

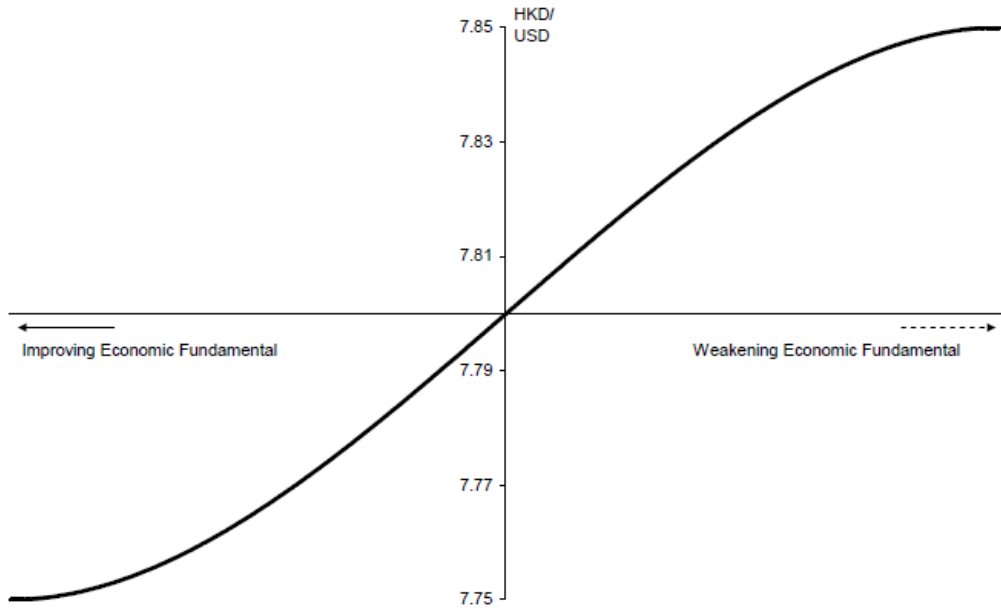

Fig. 14. *S-shaped relationship between the Hong Kong-dollar exchange rate and monetary fundamental (after Yiu, Ho, Ma, Tsang (2010)).*

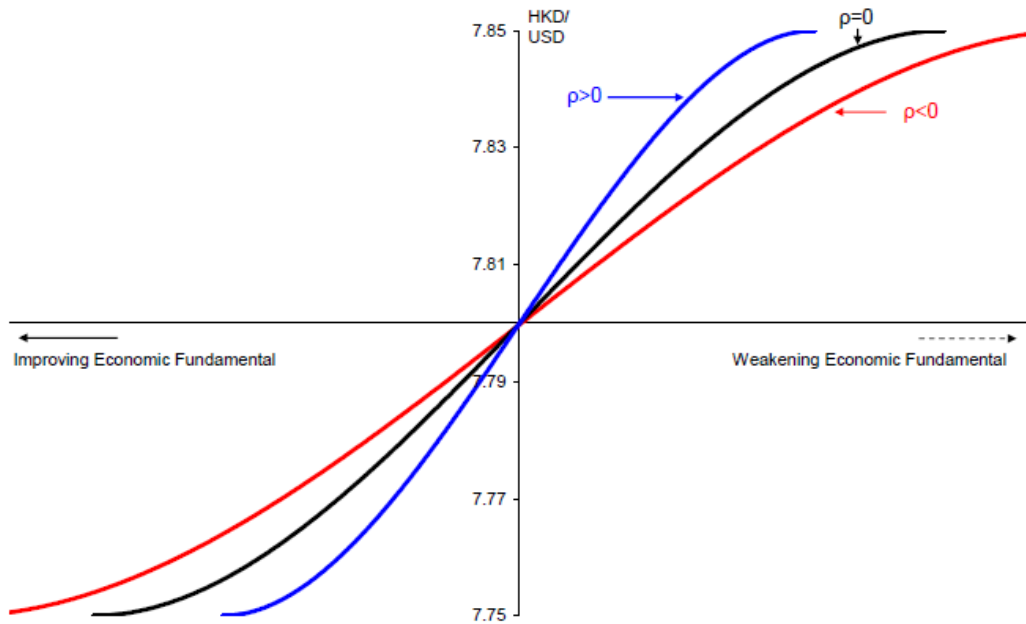

Fig. 15. *Tilted S-shaped relationship under different correlations between monetary and equity fundamentals (after Yiu, Ho, Ma, Tsang (2010)).*

The *accurate characterization of the foreign currencies exchange rates dynamics* in *foreign currencies exchange markets* over the *certain time period* can be done with an application of the *probability theory* and the *statistics theory*. The significant research achievements in the *probability theory* in the *mathematics* in *De Laplace (1812)*, *Bunyakovsky (1846)*, *Chebyshev (1846, 1867, 1891)*, *Markov (1890, 1899, 1900, 1906, 1907, 1908, 1910, 1911, 1912, 1913)*, *Kolmogorov (1938, 1985, 1986)*, *Wiener (1949)*, *Brush (1968, 1977)*, *Shiryayev (1995)*, *Ledenyov (2004)* made it possible to estimate the *valuable financial papers prices evolutions* in *Bachelier (1900)*. Presently, there is a considerable number of theoretical models with the application of the *probability theory* and the *statistics theory* in the *finances* to predict the *foreign currencies exchange rates evolutions* in the *foreign currencies exchange markets* in *Morgenegg (1990)*, *Müller, Dacorogna, Olsen, Pictet, Schwarz, Morgenegg (1990)*, *Dacorogna, Müller, Nagrel, Olsen, Pictet (1993)*, *Peters (1994)*, *Ghysels, Jasiak (1995)*, *Schnidrig, Würtz (1995)*, *Mantegna, Stanley (1995)*, *Guillaume, Dacorogna, Dave, Muller, Olsen, Pictet (1997)*, *Shiryayev (1995, 1998a)*.

Let us write the *mathematical formulas* and provide some *graphical illustrations* to review the *modern theoretical conceptions* on the *electronic trading* in the *foreign exchange markets*. To achieve this goal, we prefer to rely on the consistent scientific explanations with mathematical formulas by *Prof. Albert N. Shiryayev, Steklov Mathematical Institute and Moscow State University* in *Shiryayev (1998a, 1999)*. Before starting the review, let us note that the *DEM* currency is no longer in the use in *Germany*. In a general case, the “ask price” S_t^a of the *Currency¹* in relation to the *Currency²* can be written as in the proposed formula, and the dynamics of the *foreign currencies exchange rate* can change approximately as in Fig. 16 in *Shiryayev (1998a)*

$$S_t^a = \left(\frac{\text{Currency}^1}{\text{Currency}^2} \right)_t^a, \quad t \geq t_0.$$

The *foreign currencies exchanges rates dynamics* is usually characterized by the high frequency changes, which are called the *ticks*, as explained in *Goodhart (1988, 1989, 1992)*, *Goodhart, Demos (1990, 1991a, b)*, *Goodhart, Curcio (1991)*, *Goodhart, Figliuoli (1991)*, *Goodhart, Hall, Henry, Pesaran (1993)*, *Goodhart, Hesse (1993)*, *Goodhart, Ito, Payne (1995, 1996)*, *Goodhart, O'Hara (1995)*, *Goodhart, O'Hara (1997)*, *Goodhart, Love, Payne, Rime (2002)*. The *statistics of ticks* is analyzed with the purpose to understand the nature of the *foreign currencies exchanges rates dynamics*. The graph with the average number of ticks over the certain time period is shown in Fig. 17 in *Ghysels, Jasiak (1995)*, *Shiryayev (1998a)*, aiming to

illustrate the exchange rate activity at the *FX* market from *Monday* to *Friday* with *5min* time interval.

In addition, the change dynamics of an *average number of ticks* of the *selected foreign currencies exchange rate* over 24 hours from 05.10.92 to 26.09.93 is demonstrated in Fig. 18 in *Schnidrig, Würtz (1995), Shiryayev (1998a)*.

Speaking about of the discrete statistical data, let us assume that $S_t^a = S_0^a e^{H_t^a}$ is the *ask price*, $S_t^b = S_0^b e^{H_t^b}$ is the *bid price*, $S_t^a - S_t^b$ is the *difference* or the *spread*, then we can write in *Shiryayev (1998a)*

$$S_t = \sqrt{S_t^a \cdot S_t^b}$$

The modification of the *discrete-change process* (S_t) on the *continuous-change process* (\tilde{S}_t) in the *foreign currencies exchange rate dynamics* over the *time* is presented in Fig. 19 in *Shiryayev (1998a)*, where the *discrete-change process* in the *foreign currencies exchange rate dynamics* over the *time* is given as in *Shiryayev (1998a)*

$$S_t = S_0 + \sum_{k \geq 1} \xi_k \mathbf{I}(\tau_k \leq t),$$

the *continuous-change process* in the *foreign currencies exchange rate dynamics* over the *time* can be written as in *Shiryayev (1998a)*

$$\tilde{S}_t = S_{\tau_k} \frac{\tau_{k+1} - t}{\tau_{k+1} - \tau_k} + S_{\tau_{k+1}} \frac{t - \tau_k}{\tau_{k+1} - \tau_k}, \quad \tau_k < t \leq \tau_{k+1}.$$

During the statistical analysis of financial data, the various types of statistical distributions can be applied, and the possible deviations of registered parameters can be measured with the $\mathbf{Q}\hat{\mathbf{Q}}$ *quantile analysis method* as shown in Figs. 20 and 21. In Fig. 20, we can see the $\mathbf{Q}\hat{\mathbf{Q}}$ *quantile analysis* of the *DEM/USD* currencies exchange rate with the interval $\Delta=20$ *min* , using the data by the *Reuters* agency from 05.10.92 to 26.09.93, where the quantiles $\hat{\mathbf{Q}}_p$ of empirical distribution of the values $\tilde{h}_k = \tilde{h}_{t_k}^{(\Delta)}$, $t_k = k\Delta$, $k = 1, 2, \dots$ are shown along the vertical axis; the quantiles \mathbf{Q}_p of normal distribution are depicted along the horizontal axis in *Schnidrig, Würtz (1995), Shiryayev (1998a)*. In Fig. 21, the typical graphs of the empirical density $\tilde{h}_k = \tilde{h}_{t_k}^{(\Delta)}$, $k = 1, 2, \dots$, and the corresponding theoretical (normal) density are presented in *Shiryayev (1998a)*.

Discussing the one dimensional distributions of the relative changes of prices, it is necessary to note the two things, namely that the “*long tails*” effect can be approximated with the

application of a number of different statistical distributions; and the *scaling behaviour* can be observed in the *foreign currencies exchange rates changes dynamics*, the schematic graph of behaviour of $\log_{10} p_0^{(\Delta)}(\mathbf{x})$ at the two various values of Δ is drawn in Fig. 22 in *Mantegna, Stanley (1995), Shiryayev (1998a)*.

Speaking about the volatility, the Figs. 23 and 24 illustrate the daily inhomogeneity and periodicity of volatility in the selected week $v_{((k-1)\Delta, k\Delta]}(\mathbf{H}; \Delta) = |\tilde{\mathbf{h}}_k|$ on the time intervals $((k-1)\Delta, k\Delta], k = 1, 2, \dots$ during the week. Fig. 23 shows the daily volatility of the *DEM/USD* exchange rate $\Delta = 1 \text{ hour}$, going from the data by the *Reuters* agency from 05.10.92 to 26.09.93 in *Schnidrig, Würtz (1995), Shiryayev (1998a)*. Fig. 24 depicts the weekly volatility of the *DEM/USD* exchange course $\Delta = 1 \text{ hour}$ during the week in *Schnidrig, Würtz (1995), Shiryayev (1998a)*. The intervals $(0,1], \dots, (167, 168]$ correspond to the time intervals $(0:00, 1:00], \dots, (23:00, 24:00]$ in the *Greenwich mean time*. The data belong to the *Reuters* agency (05.10.1992 - 26.09.1993).

Discussing the *statistics of volatility*, Fig. 25 illustrates the fractal structure of Δ volatility $\hat{v}_T(\Delta)$ in *Shiryayev (1998a)*. The $\ln \hat{v}_T(\Delta)$ values are placed along the vertical axis as a function of $\ln \Delta$ (the horizontal axis). It can be seen that the volatility $\ln \hat{v}_T(\Delta)$ as a function of $\ln \Delta$ has the fractal structure with the *Hurst constant* equal to $\mathbf{H} \cong 0.585$ in *Guillaume, Dacorogna, Dave, Muller, Olsen, Pictet (1997), Müller, Dacorogna, Olsen, Pictet, Schwarz, Morgenegg (1990), Peters (1994), Schnidrig, Würtz (1995), Shiryayev (1998a)*. The *multi-fractals* is a subject of growing research interest in the *finances* in *Mandelbrot (1960, 1963a, b, 1965, 1965, 1967a, b, 1969, 1971, 1972, 1975a, b, 1977, 1982, 1997), Mandelbrot, Taylor (1967), Mandelbrot, van Ness (1968), Mandelbrot, Wallis (1969), Ausloos (2000), Kantelhardt, Zschiegner, Koscielny-Bunde, Havlin, Bunde, Stanley (2002), Norouzzadeh, Rahmani (2006), Kim, Yoon (2004), Jiang, Ma, Cai (2007), Jiang, Zhou (2009), Liu, Qian, Lu (2010), Wang, Yu, Suo (2012), Trenca, Plesoianu, Căpusan (2012)*.

Considering the *correlation properties of stationary time series*, it is necessary to note that the *empirical autocorrelation function* $\hat{\rho}(\mathbf{k})$ of increments sequence $\tilde{\mathbf{h}}_n$ in the *DEM/USD* exchange rate with $\Delta = 1 \text{ min}$ is pictured in Fig. 26 in *Guillaume, Dacorogna, Dave, Müller, Olsen, Pictet (1997), Shiryayev (1998a)*

$$\rho(\mathbf{k}) = \frac{\langle \tilde{\mathbf{h}}_n \tilde{\mathbf{h}}_{n+k} - \langle \tilde{\mathbf{h}}_n \rangle \cdot \langle \tilde{\mathbf{h}}_{n+k} \rangle}{\sqrt{D\tilde{\mathbf{h}}_n \cdot D\tilde{\mathbf{h}}_{n+k}}},$$

where $\tilde{\mathbf{h}} = (\tilde{\mathbf{h}}_1, \tilde{\mathbf{h}}_2, \dots)$ is the stationary time series.

The empirical autocorrelation function $\hat{R}(k)$ of increments sequence $|\tilde{h}_n|$ in the DEM/USD exchange rate, where $k=504$ corresponds to 1 week, $k=2016$ relates to 4 weeks, with the Reuters agency data (05.10.1992 - 26.09.1993) is shown in Fig. 27 in Dacorogna, Müller, Nagrel, Olsen, Pictet (1993), Guillaume, Dacorogna, Dave, Müller, Olsen, Pictet (1997), Shiryayev (1998a), aiming to demonstrate the cyclical nature of the autocorrelation function $R(k)$

$$R(k) = \frac{\Psi|\tilde{h}_n| |\tilde{h}_{n+k}| - \Psi|\tilde{h}_n| \cdot \Psi|\tilde{h}_{n+k}|}{\sqrt{D|\tilde{h}_n| \cdot D|\tilde{h}_{n+k}|}},$$

where $|\tilde{h}| = (|\tilde{h}_1|, |\tilde{h}_2|, \dots)$ is the stationary time series.

The empirical autocorrelation function $\hat{R}^*(\theta), \theta \geq 0$ of the increments sequence $|\tilde{h}_n^*| = (|\tilde{h}_0^*|)_{\theta \geq 1}$ of the de-volitized values in the operational “ θ -time” with the interval $\Delta\theta=20\text{min}$ in the DEM/USD exchange rate is presented in Fig. 28 in Dacorogna, Müller, Nagrel, Olsen, Pictet (1993), Shiryayev (1998a).

Fig. 29 illustrates the process of conversion of the operational time into the real physical time $t = \tau^*(\theta)$ in Dacorogna, Müller, Nagrel, Olsen, Pictet (1993), Shiryayev (1998a). The dependence $t = \tau^*(\theta)$ is linear during 5 business days, but it is nonlinear at the end of the week.

In Fig. 30, the solid line represents a periodic part in activity of the CHF/USD exchange rate, 168 hours = 1 week, in Dacorogna, Müller, Nagrel, Olsen, Pictet (1993), Shiryayev (1998a).

Fig. 31 presents the description of the clustering effect in $\tilde{h}_k = \tilde{h}_k^{(\Delta)}$ values in the DEM/USD exchange rate, $\Delta=20\text{min}$, $k=504$ corresponds to 1 week, $k=2016$ corresponds to 4 weeks. Clots with “small” and “big” values of $|\tilde{h}_k|$ are clearly visible in Schnidrig, Würtz (1995), Shiryayev (1998a).

In Tab. 4, the figures demonstrate various techniques on the statistical analysis of the foreign currencies exchange rates fluctuations during the electronic trading in the foreign currencies exchange markets in Morgenegg (1990), Müller, Dacorogna, Olsen, Pictet, Schwarz, Morgenegg (1990), Dacorogna, Müller, Nagrel, Olsen, Pictet (1993), Peters (1994), Ghysels, Jasiak (1995), Schnidrig, Würtz (1995), Mantegna, Stanley (1995), Guillaume, Dacorogna, Dave, Muller, Olsen, Pictet (1997), Shiryayev (1998a).

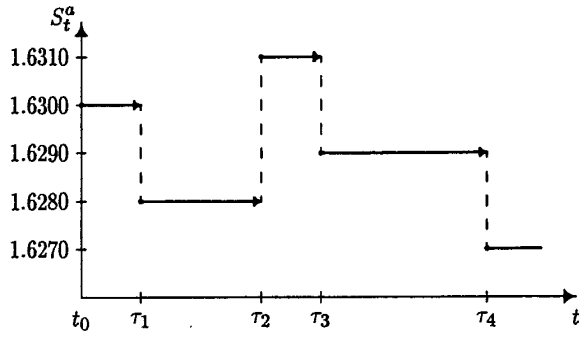

Fig. 16. Behaviour of currencies exchange rate S_t^a , (after Shiryaev (1998a)).

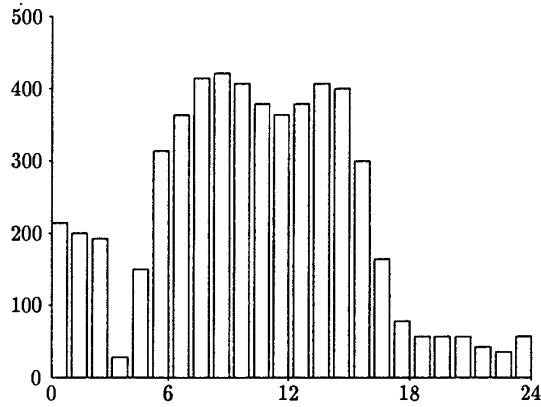

Fig. 18. Average number of ticks per day in DEM/USD exchange rate from 05.10.92 to 26.09.93 (after Shiryaev (1998a)).

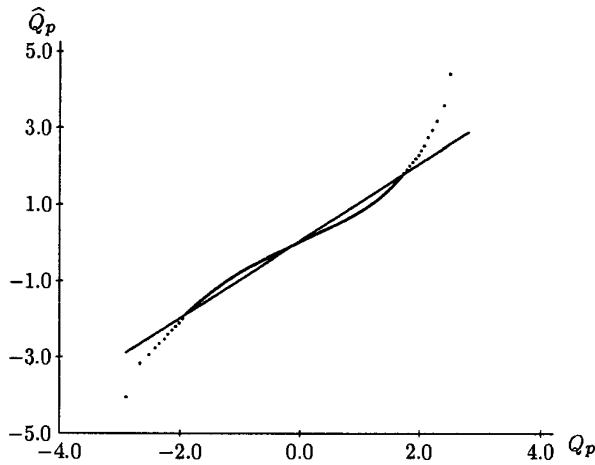

Fig. 20. QQ quantile analysis of DEM/USD currencies exchange rate with interval $\Delta=20$ min (after Shiryaev (1998a)).

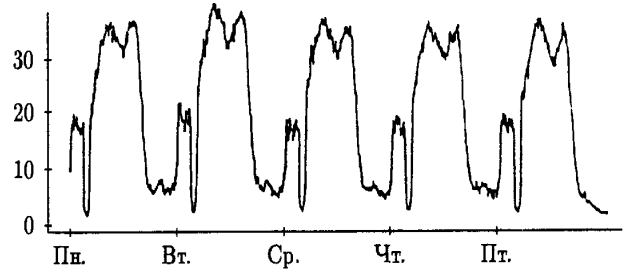

Fig. 17. DEM/USD exchange rate activity from Monday to Friday with 5min interval, average number of ticks vs time (after Shiryaev (1998))

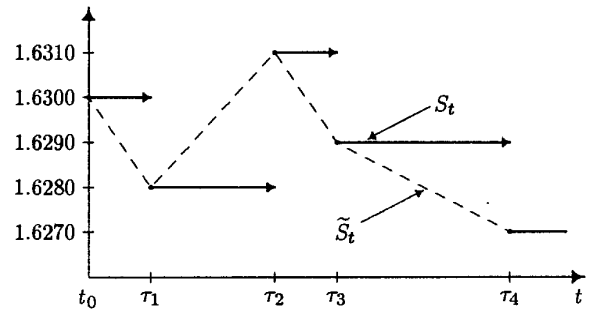

Fig 19. Modification of discrete-change process (S_t) on continuous-change process (\tilde{S}_t) of foreign currencies exchange rate dynamics (after Shiryaev (1998a)).

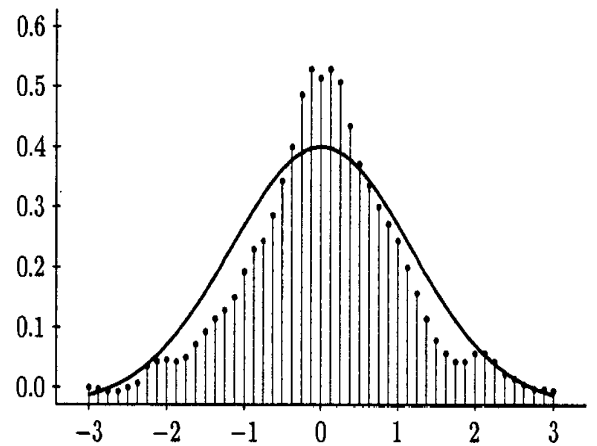

Fig. 21. Typical graph of empirical density $\tilde{h}_k = \tilde{h}_k^{(\Delta)}$, $k = 1, 2, \dots$ and corresponding theoretical (normal) density (after Shiryaev (1998a)).

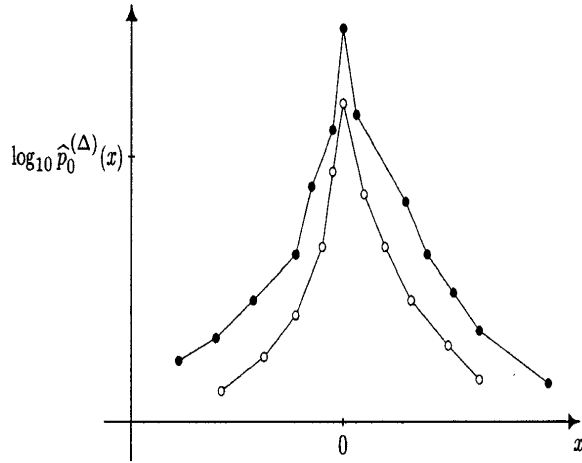

Fig. 22. Schematic graph of behaviour of $\log_{10} p_0^{(\Delta)}(x)$ at two various values of Δ (after Shiryayev (1998a)).

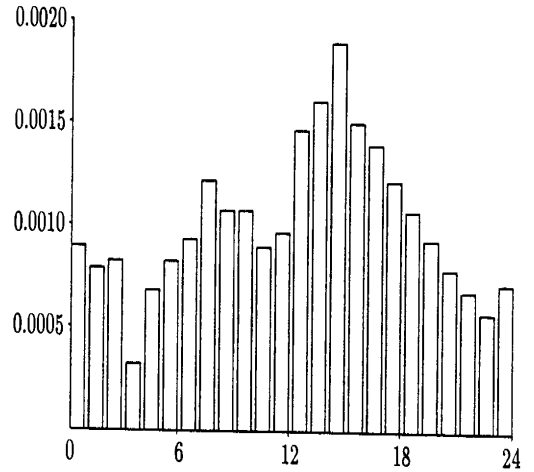

Fig. 23. Daily volatility of DEM/USD exchange rate $\Delta = 1$ hour (after Shiryayev (1998a)).

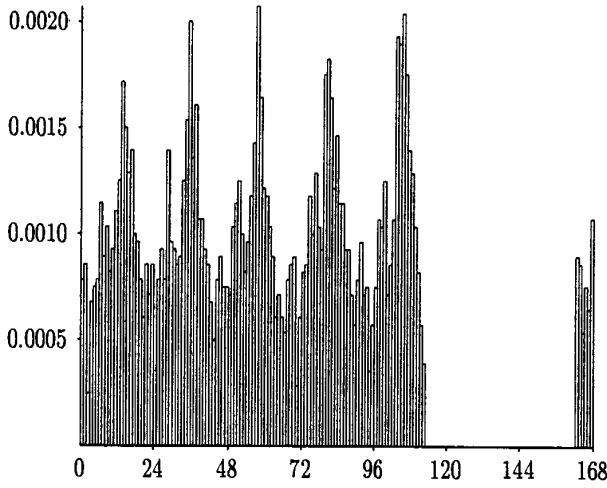

Fig. 24. Weekly volatility of DEM/USD exchange course $\Delta = 1$ hour (after Shiryayev (1998a)).

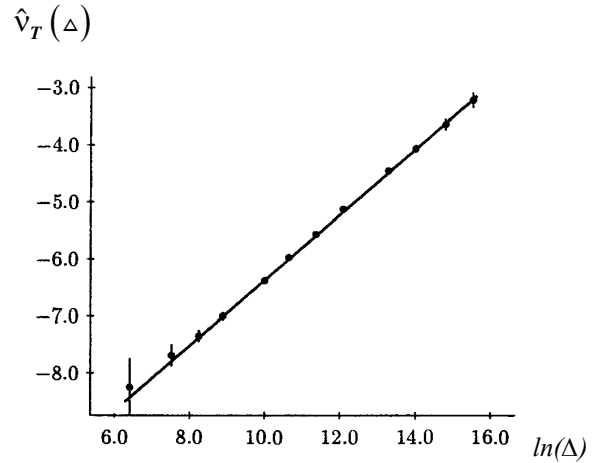

Fig. 25. Illustration of fractal structure of Δ volatility $\hat{V}_T(\Delta)$ (after Shiryayev (1998a)).

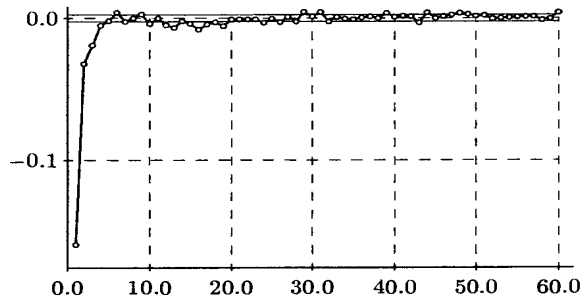

Fig. 26. Empirical autocorrelation function $\hat{\rho}(k)$ of increments

sequence \tilde{h}_n in DEM/USD exchange rate, $\Delta = 1$ min (after Shiryayev (1998a)).

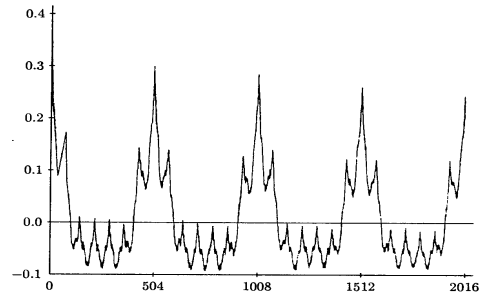

Fig. 27. Empirical autocorrelation function $\hat{R}(k)$ of increments

sequence $\left| \tilde{h}_n \right|$ in DEM/USD exchange rate, $k=504$ corresponds to 1 week, $k=2016$ corresponds to 4 weeks (after Shiryayev (1998a)).

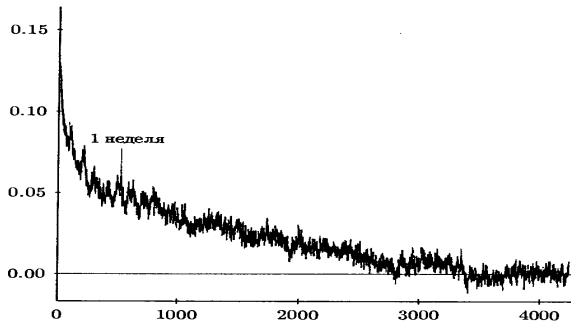

Fig. 28. Empirical autocorrelation function $\hat{R}^*(\theta)$ of increments sequence $|\tilde{h}_n^*|$ of de-volitized values in operational “ θ -time” with interval $\Delta\theta=20\text{min}$ in DEM/USD exchange rate (after Shiryayev (1998a)).

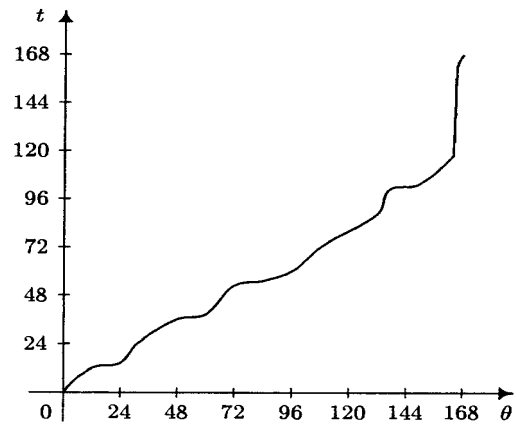

Fig. 29. Conversion of operational time into real physical time $t = \tau^*(\theta)$ (after Shiryayev (1998a)).

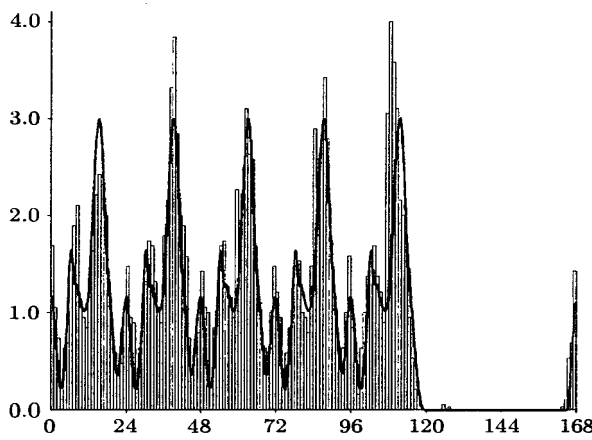

Fig. 30. Solid line represents periodic part in activity of CHF/USD exchange rate, 168 hours = 1 week (after Shiryayev (1998a)).

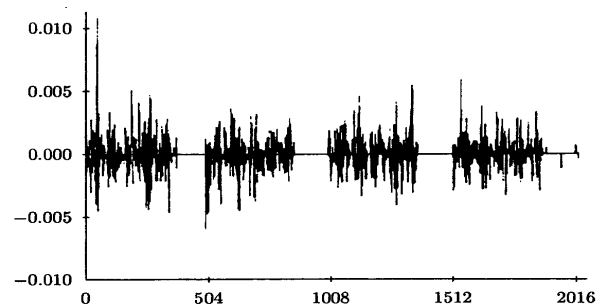

Fig. 31. Clustering effect in $\tilde{h}_k = \tilde{h}_k^{(\Delta)}$ values in DEM/USD exchange rate, $\Delta=20\text{min}$, $k=504$ corresponds to 1 week, $k=2016$ corresponds to 4 weeks. Clots with “small” and “big” values of $|\tilde{h}_k|$ are clearly visible (after Shiryayev (1998a)).

Tab. 4. Statistical analysis of currencies exchange rates fluctuation in foreign exchange markets (after Morgenegg (1990), Müller, Dacorogna, Olsen, Pictet, Schwarz, Morgenegg (1990), Dacorogna, Müller, Nagrel, Olsen, Pictet (1993), Peters (1994), Ghysels, Jasiak (1995), Schnidrig, Würtz (1995), Mantegna, Stanley (1995), Guillaume, Dacorogna, Dave, Muller, Olsen, Pictet (1997), Shiryayev (1998a, 1999)).

The most innovative researches on the theory of foreign currencies exchange rates dynamics in the foreign currencies exchange markets and closely related scientific subjects have been done by many distinguished scientists as shown in the chronological order below in Ellis, Metzler (editors) (1949), Machlup (1949), Robinson (1949), Friedman (1953), Baumol (1957), Debreu (1959), Fama (1965, 1970, 1984, 1998), Fama, Blume (1966), Fama, French (1988, 1996), Fama, Hansen, Shiller (2013), Demsetz (1968), Radner (1968), Bates, Granger (1969), Akerlof (1970), Arrow (1970), Black (1971, 1986), Black, Scholes (1973), Merton (1973),

Newbold, Granger(1974), Fleming (1975), Shapiro (1975), Dooley, Shafer (1976), Dornbusch (1976, 1987), Frankel (1976, 1979, 1982a, b, 1983, 1992, (editor) 1993), Frankel, Froot (1987, 1990a, b, c), Frankel, Goldstein, Mason (1991), Frankel, Rose (1994, 1995), Frankel, Galli, Giovannini (editors) (1996), Frankel, Poonawala (2004), Garman (1976), Grossman (1976), Grossman, Stiglitz (1980), Grossman, Miller (1988), Kouri (1976), McKinnon (1976), Mussa (1976, 1979, 1981, 1984), Williamson (1976), Branson (1977), Branson, Halttunen, Masson (1977), Branson, Henderson (1985), Clark, Logue, Sweeney (editors) (1977), Girton, Henderson (1977), Cornell, Dietrich (1978), Cornell (1982), Stoll (1978, 1985, 1989, 1995, 1998, 2006), Huang, Stoll (1996, 1997), Stoll, Schenzler (2005), Blanchard (1979), Brunner, Meltzer (editors) (1979), Deardorff (1979), Goodman (1979), Aliber (1980, 2002), Allen, Kenen (1980), Amihud, Mendelson (1980), Amihud, Ho, Schwartz (editors) (1985), Amihud (1994a, b, c) Amihud, Levich (editors) (1994), Hansen, Hodrick (1980), Hellwig (1980, 1982), Krugman (1980, 1984, 1991, 1999), Krugman, Miller (1993), Callier (1981), Cohen, Maier, Schwartz, Whitcomb (1981), Cox, Ingersoll, Ross (1981), Diamond, Verrecchia (1981), Diamond (1982), Fieleke (1981), Ho, Stoll (1981, 1983), Loosignian (1981), Stigum (1981, 1990), Dooley, Isard (1982), Hansen (1982), Hodder (1982), Milgrom, Stokey (1982), Taylor D (1982), Bigman, Taya (editors) (1983), Copeland, Galai (1983), Dooley, Shafer (1983), Edwards (1983), French (1983), Garman, Kohlhagen (1983), Meese , Rogoff (1983a, b, 1988) Rogoff (1984, 1985, 1996), Meese (1986, 1990), Obstfeld, Rogoff (1995, 1998), Robinson (1983), Adler, Dumas (1984), Backus (1984), Bilson, Marston (editors) (1984), Booth (1984), Engel, Frankel (1984a, b), Engel, Hamilton (1990), Engel (1992, 1995, 1996, 1999), Devereux, Engel (1999, 2002), Devereux, Shi (2005), Engel, West (2004a b, 2005, 2006), Engel, Mark, West (2007), Garner, Shapiro (1984), Loopesko (1984), Roll (1984), French, Roll (1986), Roll (1988), White, Domowitz (1984), Bahmani-Oskooee, Das (1985), Cohen, Conroy, Maier (1985), Glosten, Milgrom (1985), Glosten, Harris (1988), Glosten (1989, 1994), Hakkio, Pearce (1985), Hardouvelis (1985), Jones, Kenen (editors) (1985), Kearney, Macdonald (1985), Kyle (1985, 1989), Kyle, Xiong (2001), Levich (1985), McInish, Wood (1985), Dominguez (1986, 1990, 1992, 1993, 1998, 2003a, b), Dominguez, Frankel (1993a, b, c), Bollerslev (1986, 1990), Baillie, Bollerslev (1989, 1990, 1991), Bollerslev, Chou, Jayaraman, Kroner (1990), Bollerslev, Domowitz (1991, 1993), Bollerslev, Melvin (1994), Andersen, Bollerslev (1994, 1998), Bollerslev, Engle, Nelson (1995), Bollerslev, Cai, Song (2000), Andersen, Bollerslev, Diebold, Labys (2000, 2001, 2003), Andersen, Bollerslev, Diebold, Vega (2001, 2003), Andersen, Bollerslev, Diebold (2007), Engle (1982) Engle, Bollerslev (1986), Engle, Granger (1987), Engle, Rodriguez (1989), Engle, Ito, Lin Wen-Ling (1990), Engle, Russell (1995), Engle, Gallo (2006), Evans (1986), Flood, Lessard

(1986), Grammatikos, Saunders, Swary (1986), Harris (1986, 1990), Hart, Kreps (1986), Lyons (1986, 1988, 1990, 1991, 1992, 1993a, b, c, 1994, 1995, 1996a, b, 1997a, b, c, 1998a, b, 2001, 2002a, b, 2003, 2006), Baldwin, Lyons (1994), Lyons, Rose (1995), Fan, Lyons (2001, 2003), Killeen, Lyons, Moore (2001), Killeen, Hau, Moore (2001), Killeen, Lyons, Moore (2006), O'Hara, Oldfield (1986), Burdett, O'Hara (1987), O'Hara (1995, 1998), Shleifer (1986), Shleifer, Summers (1990), Sweeney (1986), DeLong, Shleifer, Summers, Waldmann (1990), Bilson, Hsieh (1987), Glassman (1987), Gerlach (1987), Hasbrouck, Ho (1987), Hasbrouck (1988, 1991), Hasbrouck, Sofianos (1993), Hasbrouck, Seppi (2001), Hodrick (1987), Ito, Roley (1987, 1990), Canova, Ito (1991), Ito, Engle, Lin (1992), Ito, Lin (1992), Ito, Isard, Symansky, Bayoumi (1996), Ito, Lyons, Melvin (1998), Ito (2002, 2005a, b), Ito, Hashimoto (2006), Mendelson (1987), Newey, West (1987), Rubinstein, Wolinsky (1987), Taylor (1987, 1989, 1995, 2005), Allen, Taylor (1989), Taylor, Allen (1992), Sarno, Taylor (2000, 2001a, b), Sager, Taylor (2005, 2006, 2008), Reitz, Taylor (2006), Schulmeister (1987), Melvin, Taylor (2009), Newey, West (1987), Wolff (1987), Admati, Pfleiderer (1988, 1989), Boothe (1988), Choi, Salandro, Shastri, Clinton (1988), Goodhart (1988, 1989, 1992), Goodhart, Demos (1990, 1991a, b), Goodhart, Curcio (1991), Goodhart, Figliuoli (1991), Goodhart, Hall, Henry, Pesaran (1993), Goodhart, Hesse (1993), Goodhart, Ito, Payne (1995, 1996), Goodhart, O'Hara (1995), Goodhart, O'Hara (1997), Goodhart, Love, Payne, Rime (2002), Hardouvelis (1988), Lewis (1988, 1995), Baldwin, Krugman (1989), Baxter, Stockman (1989), Dooley, Lizondo, Mathieson (1989), Giovannini (1989), Golub (1989), Humpage (1989), Leach, Madhavan (1989), Leahy (1989), Miller, Eichengreen, Portes (editors) (1989), Van Hagen (1989), Allen, Taylor (1990), Allen, Karjalainen (1999), Courakis, Taylor (1990), Diebold, Nason (1990), Flood, Hodrick (1990), Flood, Rose (1995), Flood, Taylor (1996), Flood, Marion (2001), Foster, Viswanathan (1990), Foster, Viswanathan (1993), Holthausen, Leftwich, Mayers (1990), De Long, Shleifer, Summers, Waldmann (1990), Domowitz (1990, 1993), Domowitz, Steil (1999), Johansen, Juselius (1990), Johansen (1991, 1992), Jorion (1990, 1991, 1996), Lo, MacKinley (1990), Melino, Turnbull (1990, 1995), Mishkin (1990), Müller, Dacorogna, Olsen, Pictet, Schwarz, Morgenegg (1990), Müller, Dacorogna, Dave, Pictet, Olsen, Ward (1993), Müller, Dacorogna, Dave, Olsen, Pictet, von Weizsäcker (1995), Roell (1990), Seppi (1990), Bali (1991), Bhattacharya, Spiegel (1991), Black (1991), Bossaerts, Hillion (1991), Burnham (1991), Campbell, LaMaster, Smith, Van Boening (1991), Campbell, Lo, MacKinlay (1997), Chinn (1991), Chinn, Meese (1995), Chowdhry, Nanda (1991), Edwards (1991), Froot, Obstfeld (1991), Froot, Rogoff (1995), Froot, Ramadorai (2002), Froot, Donohue (2004), Froot, Ramadorai (2005), Georg, Kaul, Nimalendran (1991), Grabbe (1991), Harvey, Huang (1991),

Khonry (editor) (1991), Kim, Verrecchia (1991, 1994, 1997), Klein (1991), Klein, Rosengren (1991), Lease, Masulis, Page (1991), LeBaron (1991), Lee, Ready (1991), Messe, Rose (1991), Subrahmanyam (1991), Spiegel, Subrahmanyam (1992, 1995), Williamson (1991), Bekaert, Hodrick (1992), Choi, Elyasiani, Kopecky (1992), Choi, Elyasiani (1997), Curcio, Goodhart (1992), Curcio, Goodhart, Guillaume, Payne (1997), De Grauwe, Decupere (1992), De Grauwe, Grimaldi (2006a, b), Edison (1992, 1993, 2003), Edison, Liang (1999), Flood (1992, 1994), Flood, Rose (1995), Flood, Huisman, Koedijk, Mahieu (1996, 1998), Gosh (1992), Guillaume, Dacorogna, Dave, Muller, Olsen, Hamon, Jacquillat (1992), Guillaume, Pictet, Dacorogna (1995), Guillaume, Dacorogna, Dave, Muller, Olsen, Pictet (1997), Hansen (1992), Holden, Subrahmanyam (1992), Neal (1992), Pesaran, Samiei (1992), Rhee, Chang, Svensson (1992, 1993), Bertola, Svensson (1993), Rose, Svensson (1994), Taylor S J (1992), Zhou (1992a, b, 1997), Bank for International Settlements (1993, 1999a, b, 2001, 2002, 2004 2005, 2007, 2010), Bertola, Svensson (1993), Biais (1993), Chan, Weinstein (1993), Cheung (1993), Cheung, Ng (1996), Cheung, Chinn (1998, 2001), Cheung, Wong (1999, 2000), Cheung, Chinn, Marsh (2004), Cheung, Chinn, Pascual (2004, 2005), Dacorogna, Muller, Nagrel, Olsen, Pictet (1993), Dacorogna, Muller, Pictet, de Vries (1995), Dominguez, Frankel (1993), Dominguez (1998, 2006), Dominguez, Panthaki (2006), Ederington, Lee (1993), Edin, Vredin (1993), Goldstein, Folkerts-Landau, Garber, Rojas-Suarez, Spencer (1993), Griffiths, White (1993), Grimes (1993), Harris, Raviv (1993), Klein (1993), Levich, Thomas (1993), Matsuyama, Kiyotaki, Matsui (1993), Romer (1993), Schmidt, Iversen, Treske (1993), Schmidt, Iversen (1993), Schmidt, Oesterhelweg, Treske (1996), Wolinsky (1990), Ammer, Brunner (1994), Andrew, Broadbent (1994), Bakker, Boot, Sleijpen, Vanthoor (editors) (1994), Bartov, Bodnar (1994, 1995), Berry, Howe (1994), Bessembinder (1994), Ball, Roma (1994), Brousseau, Czarnecki (1994), De Jong (1994), De Jong, Nijman, Röell (1995), De Jong, Nijman, Röell (1996), De Jong, Mahieu, Schotman (1998), De Jong, Ligterink, Macrae (2006), De Jong, Verschoor, Zwinkels (2010), Degryse, de Jong, van Kervel (2011), Dini (1994), Fialkowski, Petersen (1994), Glass (1994), Grünbichler, Longstaff, Schwartz (1994), Hansch, Naik, Viswanathan (1994), Hirschleifer, Subrahmanyam, Titman (1994), Hogan, Melvin (1994), Jones, Kaul, Lipson (1994), Jones, Lipson (1999), Kraus, Smith (1994), Massib, Phelps (1994), Mendelson, Peake (1994), Naidu, Rozeff (1994), Nieuwland, Verschoor, Wolff (1994), Pictet, Dacorogna, Muller, De Vries (1994), Sharpe (1994), Silber (1994), Slezak (1994), Szpiro (1994), Yadav, Pope, Paudyal (1994), Walsh (1994), Wei (1994), Watanabe (1992), Watanabe, Harada (2004), Watanabe, Yabu (2007), Almekinders (1995), Chiang, Jiang (1995), Dumas, Solnik (1995), Ederington, Lee (1995), Evertsz (1995), Faruquee (1995), Frino, McCorry (1995), Frino, McInish, Toner (1998), Ghysels,

Jasiak (1995), Grossman, Rogoff (1995), Havrilesky (1995), Hong, Wang (1995), Isard (1995), Kandel, Pearson (1995), Lewis (1995), Lin, Sanger, Booth (1995), Mantegna, Stanley (1995), Mark (1995, 2001, 2009), Mark, Wu (1998), Obstfeld, Rogoff (1995, 1998), Osler (1995, 1998, 2000, 2003, 2005, 2006, 2008, 2009, 2012), Carlson, Osler (1999, 2005), Kevin, Osler (1999), Osler, Vandrovych (2009), Osler, Yusim (2009), Osler, Mende, Menkhoff (2011), Osler, Savaser (2011), Dahl, Carlson, Osler (2011), Peiers (1995), Prasad, Rajan (1995), Schnidrig, Würtz (1995), Schwartz (editor) (1995), Shyy, Lee (1995), Shyy, Vijayraghavan, Scott-Quinn (1996), Vivex (1995), Zaheer, Zaheer (1995), Bonser – Neal, Tanner (1996), Claassen (1996), Danker, Haas, Henderson, Symanski, Tryon (1996), Dukas, Fatemi, Tavakkol (1996), Dwyer, Locke, Yu (1996), Easley, Kiefer, O’Hara, Paperman (1996, 1997a, b), Easley, O’Hara, Srinivas (1998), Flemming, Ostdiek, Whaley (1996), Gagnon (1996), Ghashghaie, Breymann, Peinke, Talkner, Dodge (1996), Hsieh, Kleidon (1996), Ingersoll (1996), Kaminsky, Lewis (1996), LeBaron (1996), MacDonald, Marsh (1996), Madrigal (1996), Mosekilde (1996), Pirrong (1996), Rosenberg (1996), Tsang (1996, 1998, 1999a, b), Tsang, Sin, Cheng (1999), Tsang, Yue (2002), Vermeiren, Ková (1996), Balke, Fomby (1997), Balke, Wohar (1998), Bhattacharya, Weller (1997), Campbell, Lo, MacKinlay (1997), Campbell, Viceira (2002), Chamberlain, Howe, Popper (1997), Clarida, Taylor (1997), Clarida, Sarno, Taylor, Valente (2003), Copejans, Domowitz (1997), DeGennaro, Shrieves (1997), Dewachter (1997, 2001), Dewachter, Lyrio (2005), Embrechts, Klueppelberg, Mikosch (1997), Evans (1997, 2001, 2002, 2005, 2009, 2010, 2011), Evans, Lyons (1999, 2001a, b, c, 2002a, b, c, d, 2003, 2004a, b, 2005a, b, c, d, 2006, 2007, 2008, 2009), Cao, Evans, Lyons (2003), Evans, Hnatkovska (2005), Fleming, Remolona (1997, 1999), Fleming (2002, 2003), Franke, Hess (1997), Goldberg, Tenorio (1997), Gosh, Ostry, Gulde, Wolf (1997), Harris, Schultz (1997), Hartmann (1997, 1998a, b, 1999), Hung (1997), Kirilenko (1997), Lamoureux, Schnitzlein (1997), Madhavan, Smidt (1991, 1993), Leach, Madhavan (1993), Keim, Madhavan (1996), Madhavan, Cheng (1997), Madhavan, Richardson, Roomans (1997), Madhavan, Sofianos (1997), Madhavan (2000a, b, c), Martens (1997), Montiel (1997), Pagano, Roell (1997), Peiers (1997), Reiss, Werner (1997), Sweeney (1997, 2000), Szakmary, Mathur (1997), Vogler (1997), Wei, Kim (1997), Werner (1997), Wren-Lewis (1997), Abhyankar (1998), Abrams, Beato (1998), Anthony, MacDonald (1998, 1999), Bjønnes, Rime (1998, 2001, 2005), Bjønnes, Rime, Solheim (2005), Bjønnes, Osler, Rime (2011), Blennerhasset, Bowman (1998), Bodnar, Hayt, Marston (1998), Caramazza, Aziz (1998), Chang, Taylor (1998), Choi, Hiraki, Takezawa (1998), Chow, Chen (1998), Clark, Macdonald (1998), Covrig, Melvin (1998), Eddelbuttel, McCurdy (1998), Edison (1998), Fleming, Kirby, Ostdiek (1998), Garfinkel, Nimalendran (1998), George (1998), Hansch, Naik, Viswanathan (1998), Hau (1998), Hau,

Killeen, Moore (2000, 2002a, b), Hau, Rey (2002, 2003), He, Ng (1998), Helpman, Sadka (1998), Hong Kong Monetary Authority (1998), Isard, Faruquee (1998), Isard, Faruquee, Kincaid, Fetherston (2001), Kanas (1998), Lee (1998), Litterman, Winkelmann (1998), Lui, Mole (1998), Menkhoff (1998, 2010), Gehrig, Menkhoff (2000, 2004), Mende, Menkhoff (2003, 2006), Menkhoff, Taylor (2007), Frömmel, Mende, Menkhoff (2008), Menkhoff, Schmeling (2008, 2010), Miller, Reuer (1998), Miville, DiMillo (1998), Nagayasu (1998), Neely (1998, 2000a, b, 2004, 2005), Pesaran, Hasem, Smith (1998), Portes, Rey (1998), Rey (2001), Reiss, Werner (1998), Sarkar, Tozzi (1998), Viswanathan, Wang (1998, 2000), Vitale (1998, 1999, 2000, 2003, 2004, 2006) Yao (1998), Alberola, Cervero, Lopez, Ubide (1999), Bos, Fetherstone (1999), Carrera (1999), Chaboud, LeBaron (1999, 2001), Chaboud, Humpage (2005), Chaboud, Chernenko, Wright (2008), Chaboud, Chiquoine, Hjalmarsson, Vega (2009), Chaboud, Chiquoine, Hjalmarsson, Loretan (2009), Fiess, MacDonald (1999, 2002), Fleming, Lopez (1999), Freihube, Kehr, Krahen, Theissen (1999), Grammig, Schiereck, Theissen (1999), Isard, Razin, Rose (1999), Jeanne, Rose (1999), Kandel, Marx (1999), LeBaron (1999), Marks (1999), Macey, O'Hara (1999), Naik, Neuberger, Viswanathan (1999), Naik, Yadav (1999), Payne (1999, 2003), Payne, Vitale (2003), Moore, Payne (2011), Love, Payne (2004, 2008), Rigobon (1999), Saar (1999), Scalia, Vacca (1999), Scalia (2004, 2008), Shapiro, Varian (1999), Theissen (1999), Vayanos (1999, 2001), Wang (1999), Aliber, Chowdhry, Yan (2000), Ausloos (2000), Baillie, Humpage, Osterberg (2000), Carlson, Osler (2000), Carlson (2002), Ebrahim (2000), Eichengreen, Mathieson (2000), Greenspan (2000), Hüfner (2000), Franke, Hess (2000), Fujiwara (2000), Kanas (2000), Kaul, Mehrotra, Morck (2000), Kim, Kortian, Sheen (2000), Kim, Sheen (2002), Kim (2003), Lane, Milesi-Ferretti (2000), Lo (2000), Lee, Swaminathan (2000), Ma, Kanas (2000), Ma, Tsang, Yiu, Wai-Yip Alex Ho (2010), Martin (2000), Martin, Mauer (2003, 2005), McCallum (2000), Melvin M, Yin (2000), Melvin M, Melvin B P (2003), Melvin M, Taylor (2009), Naranjo, Nimalendran (2000), Ng (2000), Ramaswamy, Samiei (2000), Rime (2000, 2001, 2003), Akram, Rime, Sarno (2005), Rime, Sarno, Sojli (2006, 2007, 2010), Schwartz (2000), US General Accounting Office (2000), Allayannis, Ofek (2001), Anderson, Vahid (2001), Brandt, Edelen, Kavajecz (2001), Brown (2001), Cai, Cheung, Lee, Melvin (2001), Claessens, Forbes (2001), Clark, McCracken (2001), Collins, Rodrik (2001), Corsetti, Pesenti, Roubini (2001), Coval, Shumway (2001), Croushore, Stark (2001), Dacorogna, Gencay, Mueller, Olsen, Pictet (2001), D'Souza (2001), Duarte, Stockman (2001), Fischer (2001), Galati (2001), Griffin, Stulz (2001), Guembel, Sussman (2001), Hong (2001), Lane (2001), Montgomery, Popper (2001), Moore, Roche (2001, 2002), Rey (2001), Sato, Hawkins (2001), Sinn, Westermann (2001), Tse, Zobotina (2001), Williamson (2001),

Yamaguchi (2001), Aguiar (2002), Beine (2002), Cavallo, Perri, Roubini, Kisselev (2002), Chari, Kehoe, McGrattan (2002), Chari (2006), Chordia, Roll, Subrahmanyam (2002), Covrig, Melvin (2002), Danielsson, Payne (2002, 2011), Danielsson, Payne, Luo (2002), Danielsson, Love (2006), Deutsche Bundesbank (2002), Doyne, Joshi (2002), Fatum, Hutchison (2002), Fatum, King (2005), King, Sarno, Sojli (2010), King, Rime (2010), King, Mallo (2010), King, Osler, Rime (2011a, b, 2012), Kantelhardt, Zschiegner, Koscielny-Bunde, Havlin, Bunde, Stanley (2002), Galati (2002), Girardin, Horsewood (2002), Huang, Cai, Jeanne, Rose (2002), Kaul, Mehrotra (2002), Obadan (2002), Ryan, Worthington (2002), Abreu, Brunnermeier (2003), Aliber, Chowdry, Yan (2003), Bacchetta, van Wincoop (2003), Bergsten, Williamson (2003), Bodnar, Wong (2003), Burstein, Neves, Rebelo (2003), Carpenter, Wang (2003), Derviz (2003), Dominguez (2003), Dominguez, Panthaki (2006), Doukas, Hall, Lang (2003), Fatum, Hutchison (2003), Fatum, Hutchison (2006), Faust, Rogers, Wright (2003), Gordon (2003), Humpage (2003), Koutmos, Martin (2003), Laurenceson, Chai (2003), Mathisen (2003), Okunev, White (2003), Peng, Shu, Chow (2003), Rogers, Siklos (2003), Spiegel (2003), Westerhoff (2003), Wright (2003), Aitken, Frino, Hill, Jarnecic (2004), Anwar (2004), Bacchetta, van Wincoop (2004, 2006), Bartram (2004), Bartram, Bodnar (2004), Bartram, Brown, Minton (2005), Bartram, Karolyi (2006), Bhanumurthy (2004), Brandt, Kavajecz (2004), Breedon, Vitale (2004), Cashin, Cespedes, Sahay (2004), Choi, Baek (2004), De Wet, Gebreselasie (2004), Dunne, Hau, Moore (2004), Fratzscher (2004), Hahm (2004), Hui, Neely, Higbee (2004, 2007), Hui, Yeung, Fung, Lo (2007), Hui, Fong (2007), Hui, Genberg, Chung (2009), Kim, Yoon (2004), Nagayasu (2004), National Bank of Poland (2004, 2007), Reinhart, Rogoff (2004), Rigobon, Sack (2004), Simatele (2004), Akram, Rime, Sarno (2005), Ates, Wang (2005), Bauwens, Omrane, Giot (2005), Campa, Goldberg (2005, 2006a, b), Chui, Gerlach, Yu (2005), DeGrauwe (editor) (2005), Dueker, Neely (2005), Eichengreen (2005), El-Shagi, Rübel (editors) (2005), Fung, Lien, Tse, Tse (2005), Hau, Rey (2005), Inoue, Kilian (2005), Marsh, O'Rourke (2005), Newsome (2006), Vaubel (2005), Yu, Fung, Hongyi (2005), Alexander, Barbosa (2006), Bacchetta, van Wincoop (2006), Bayoumi, Lee, Jayanthi (2006), Boyen, Van Norden (2006), Cai, Howorka, Wongswan (2006), Cai, Howorka, Wongswan (2008), Cao, Evans, Lyons (2006), Carlson, Lo (2006), Charlebois, Sapp (2006), Chu, Mo, Wong, Lim (2006), Gilbert, Rijken (2006), Jeon, Oh, Yang (2006), Escribano, Pascual (2006), Kaul, Sapp (2006), Killeen, Lyons, Moore (2006), Kim, Lee, Shin (2006), Kočenda, Valachy (2006), Kočenda, Kutan, Yigit (2008), Kočenda, Poghosyan (2009), LeBaron (2006), Mende (2006), Mende, Menkhoff (2006), Muller, Verschoor (2006), Norouzzadeh, Rahmani (2006), Pelham (2006), Rodrik (2006), Sager, Taylor M P(2006), Starks, Wei (2006), Tabak, Cajueiro (2006), Taylor A,

Farstrup (2006) Taylor J B (2006), Tesfatsion, Judd (editors) (2006), Wong (2006), Adebisi (2007), Barker (2007), Bhansali (2007), Broz, Frieden, Weymouth (2007), Burnside, Eichenbaum, Rebelo (2007, 2009), Burnside (2012), Canto, Kräussl (2007), Chi, Tripe, Young (2007), Christodoulou, O'Connor (2007), Dreher, Vaubel (2007), DuCharme (2007), Egstrup, Fischer (2007), Fleming, Mizrach (2007), Fung, Yu (2007), Genberg, He, Leung (2007a, b), Genberg, Hui (2009), Hong Kong Monetary Authority (2007), Jiang, Ma, Cai (2007), Leung, Ng (2007, 2008), Mitchell, Pedersen, Pulvino (2007), Pasquariello (2007), Sahminan (2007), Scarlat, Stan, Cristescu (2007), Van Wincoop, Tille (2007), Wong J, Wong E, Fong, Choi (2007), Wong E, Wong J, Leung (2008), Yu, Fung, Tam (2007), Acemoglu, Rogoff, Woodford (editors) (2008), Baglioni, Monticini (2008), Barndorff-Nielsen, Hansen, Lunde, Shephard (2008), Bartram (2008), Beaupain, Durré (2008), Berger, Chaboud, Chernenko, Howorka, Wright (2008), Brunnermeier, Nagel, Pedersen (2008), Burnside (2008), Burnside, Eichenbaum, Kleshchelski, Rebelo, Hall L, Hall H (2008), Chinn, Moore (2008, 2011), Gagnon, Chaboud (2008), Lam, Fung, Yu (2008), Lien (2008), Lindley (2008), Liu, Tsang (2008), Liu, Fung, Tse (2008), Lo, Sapp (2008, 2010), Ramadorai (2008), Sebastião (2008), Terada, Higashio, Iwasaki (2008), Adrian, Etula, Shin (2009), Bacchetta, Mertens, Van Wincoop (2009), Baba, Packer (2009), Brunnermeier, Nagel, Pedersen (2009), Brunnermeier, Crockett, Goodhart, Persaud, Shin (2009), Bubák, Zikes (2009), Bubák, Kočenda, Žikeš (2010), De Zwart, Markwat, Swinkels, van Dijk (2009), Ding (2009), Gallardo, Heath (2009), Gençay, Gradojevic (2009), Jiang, Zhou (2009), Hattori, Shin (2009), He, Zhang, Wang (2009), Heath, Whitelaw (2011), McGuire, von Peter (2009), Meyers (2009), Muller, Verschoor (2009), Nolte I, Nolte S (2009, 2011), Serban (2009), Simwaka, Mkandawire (2009), Breedon, Vitale (2010), Breedon, Rime, Vitale (2011), Dunne, Hau, Moore (2010), Fukuda, Kon (2010), Liu, Qian, Lu (2010), Maurer, Schäfer (2010), Nightingale, Ossolinski, Zurawski (2010), Pasquariello (2010), Yiu, Ho, Ma, Tsang (2010), Diamond (2011), Durčáková (2011), Heimer, Simon (2011), Marzo, Zagaglia (2011), Moore, Payne (2011), Plantin, Shin (2011), Rafferty (2011), Wang, Wu, Pan (2011), Banti, Phylaktis, Sarno (2012), James, Marsh, Sarno (editors) (2012), Mancini, Ranaldo, Wrampelmeyer (2012), Sheng (2012a, b, 2014), Trenca, Plesoianu, Căpusan (2012), Wang, Yu, Suo (2012), Lassmann (2013).

Financial analysis methods application, including macroeconomic analysis, market microstructure analysis and order flow analysis, to forecast foreign currencies exchange rates dynamics during electronic trading process in foreign currencies exchange markets.

Let us begin the research discussion on the *financial analysis methods*. The *foreign currencies exchange markets* greatly contribute to the sustainable development of *strongly interconnected economy* of the *global knowledge society* in Hayek (1945), evolving toward the *global cloud society*, which can be characterized by such distinctive factors as:

1. The *increasing information streams generation*,
2. The *reconfigurable- topologies communication networks appearance*, and
3. The *decreasing integration of economic agents with the particular territories*.

In the research on the *foreign currencies exchange markets*, the *financial forecasting problem* is considered as one of the central research problems to understand in Dornbusch (1976). The *forecast of the trends in the foreign currencies exchange rates dynamics* is a complicated research task in the frames of the *financial forecasting problem* in Frankel, Froot (1990c). The actual *forecast of the trends in the foreign currencies exchange rates dynamics* can be done, going from the *macroeconomics principles* and the *microeconomics principles*.

Discussing the *macroeconomic forecast models*, Frankel, Galli, Giovannini (editors) (1996) note: “The basic macro model of the exchange rate implies that all information pertaining to the current and future "fundamental" determinants of exchange rates, that is, all information that implies a current and/or future change in the return on assets denominated in different currencies, has an immediate and unambiguous effect on exchange rates.” There is a number of *econometric models* to forecast the *trends in the foreign currencies exchange rates dynamics* in the *macroeconomics* in Lam, Fung, Yu (2008):

1. The *Purchasing Power Parity* model,
2. The *Uncovered Interest Rate Parity* model,
3. The *Sticky Price Monetary* model,
4. The *Bayesian Averaging Technique* model, and
5. The *Combined Forecast* model, including all the above models with benchmarks given by the *random-walk model* and the *historical average return*.

Let us continue our research discussion on the present research progress in the *foreign currencies exchange market microstructure analysis method*. Uncovering the *macroeconomic forecast models*, Frankel, Galli, Giovannini (editors) (1996) answer an important question:

“*Why study foreign exchange market microstructure?* The interest in the working of the foreign exchange markets stems, at least in part, from some of the problems that the asset market macro models have displayed. *The first is a prima facie contradiction between the models and reality.* As noted, such models imply the *absence of trading in assets*. By contrast, one of the most important empirical facts about the foreign exchange market is the high volume of transactions that occur daily. This inconsistency raises the question of whether the failure of the standard models to account for the *volume of foreign exchange transactions* is a symptom of more serious problems, which might cause the lack of success at explaining other empirical phenomena on which researchers have concentrated.

These empirical phenomena include the *behavior of excess returns in the foreign exchange market*, the *near total inability to predict exchange rates at short horizons*, the *inability to explain exchange rate movements even ex post*, and the *volatility of exchange rates*. Standard models have been unable to explain these phenomena satisfactorily. In particular, asset pricing formulas implicit in the standard macro models seem, to date, to have fared poorly. For example, even though the existence of ex ante (i.e., forecastable) returns in the *foreign exchange markets* can in theory be explained as *risk premia*, the estimated returns in practice do not match what is predicted by *asset pricing models* based on the covariances among asset returns.

Furthermore, *models seem to have a difficult time predicting future movements in exchange rates*, suggesting that the information contained in the macro variables that are usually included in these models is of limited value. Finally, the *volatility of these macro variables is generally smaller than the observed volatility of exchange rates*, suggesting that—unless certain variables have especially strong effects on the *spot exchange rate*, as, for example, in the case of large overshooting in reaction to monetary disturbances—the information affecting exchange rate movements may be in part extraneous to the variables belonging to *standard macroeconomic models*. *Theories of rational speculative bubbles* and *speculative attacks* can in one sense account for the existence of excess volatility. But they are inherently unsatisfying in that they have nothing to say about how or when such bubbles and attacks get started or how they end.

It is only natural to ask whether these empirical problems of the *standard exchange rate models*—problems that stem from the assumptions on asset market equilibrium—might be solved if the *structure of foreign exchange markets* was to be specified in a more realistic fashion. *This suggests a sort of micro-foundations approach to the foreign exchange markets, according to which a more satisfactory description of the foreign exchange market microstructure might help sort out some of the problems displayed by existing macro models.*”

Frankel, Galli, Giovannini (editors) (1996) continue: “A **second reason to study market microstructure** is only loosely related to the first. Like any market, *the foreign exchange market is an interesting subject for research that attempts to identify the economic effects of its organization*. This is, as opposed to the *macroeconomic approach to foreign exchange microstructure*, the **microeconomic approach**. The questions that are addressed with this approach include, for example, **transparency, decentralization, the use of brokers (vs. market-makers, vs. auctioneers), the location of trading, the efficiency of clearing of foreign exchange transactions, the relation between spot and derivative markets, and the importance of systemic risk in the market.**”

Discussing the most important research results, obtained during the **market microstructure analysis**, Frankel, Galli, Giovannini (editors) (1996) highlight the following facts: “The *study of market microstructure* has already produced at least one empirical regularity: the **high intraday correlation of trading volume and volatility**. As noted above, standard macroeconomic exchange rate models have little hope of explaining *trading volume*. Typically, they assume **homogeneity of market participants**. If all traders are the same, why should they trade? Of course, the standard models do not attempt to explain volume, considering it of little relevance except to those who make their living trading. But the observed correlation between volume and volatility suggests something of more general interest. Frankel and Froot (1990b), for example, find a high contemporaneous correlation between volume and volatility. They also find some evidence that dispersion of traders' forecasts, as reflected in survey data, *Granger-causes* both *volume* and *volatility*.

Given that trading volume seems to be relevant, there are two possible broad interpretations. One is that the market is processing information in an efficient way. Here, efficient is not to be understood as in the narrowest definition of the *efficient markets hypothesis*, where all traders are homogeneous, all information is instantly and fully reflected in the market price, and there are no profits to be made by trading. Rather, the **microstructure perspective presupposes heterogeneity**, is often based (more specifically) on **asymmetric information**, and allows that relatively more skillful or informed traders may succeed at the expense of those who are less skillful or less informed or of customers who must transact because they need to eliminate exposure (“*liquidity traders*”). The first interpretation is simply that the market works to aggregate the individual bits of information available to each trader in a relatively rapid and smooth way. The chapters here shed light on a number of leading *models of asymmetric information* and the *need for liquidity*.”

The advanced research papers on the *market microstructure analysis technique* in the frames of the *theory of the foreign currencies exchange rates dynamics* during the *electronic trading process* in the *foreign currencies exchange markets* and *closely related scientific topics* have been written by a number of talented scientists (*in the chronological order*) in Garman (1976), Frankel (editor) (1983, 1993), Frankel, Froot (1990c), Frankel, Galli, Giovannini (editors) (1996), O'Hara, Oldfield (1986), O'Hara (1995, 1998), Bossaerts, Hillion (1991), Lease, Masulis, Page (1991), Lyons (1993a, b, 1995, 1996a 1998b, 2005, 2006), Flood (1994), Flood, Taylor (1996), Sarno, Taylor (2001b), Sager, Taylor (2006), Massib, Phelps (1994), Goodhart, Ito, Payne (1995, 1996), Goodhart, Payne (1996), Peiers (1995), Evans (1997, 2011), Blennerhasset, Bowman (1998), Carrera (1999), Madhavan (2000), D'Souza (2001), Guembel, Sussman (2001), Dominguez (2003a), Bhanumurthy (2004), Dunne, Hau, Moore (2004), Vitale (2004, 2006), Osler (2006, 2008, 2009, 2012), King, Osler, Rime (2012), Burnside, Eichenbaum, Rebelo (2009), Trenca, Plesoianu, Căpusan (2012).

Let us focus on the research discussion toward a present state of progress in the *foreign currencies exchange market customer transactions order flow analysis methods*. Frankel, Galli, Giovannini (editors) (1996) write: “Lyons sheds some light on how bits of such information are processed, in the form of a *statistically significant effect of orders received by traders on the prices at which they transact.*”

Evans, Lyon (2005, 2006) showed that:

1. “both the *aggregate and disaggregated customer flows* received by Citibank are positively auto-correlated;
2. contemporaneous correlations across flow segments are low at the daily frequency, but high at the monthly frequency;
3. some customer segments do produce negative coefficients in contemporaneous return regressions;
4. the proportion of excess return variation that *segment flows* can account for rises with the horizon; and
5. about one-third of *order flows* power to forecast *exchange rates* one month ahead comes from *flows ability to forecast future flow.*”

Evans, Lyons (2007) researched the *transaction flows, exchange rates, and future fundamentals*, making the following predictions: “The predictions are borne out in four empirical findings that define this paper's main contribution:

1. *Transaction flows forecast future macro variables such as output growth, money growth, and inflation,*

2. Transaction flows forecast these macro variables significantly better than the exchange rate does,
3. Transaction flows (proprietary) forecast future exchange rates, and
4. The forecasted part of fundamentals is better at explaining exchange rates than standard measured fundamentals.”

Tab. 5 shows the summary statistics for the weekly data in *Evans, Lyons (2007)*: “The statistics in *Panel A* show that weekly changes in the log spot rate, $\Delta s_t \equiv s_t - s_{t-1}$; have a mean very close to zero and display no significant serial correlation. In *Panel B*: First, the order flows are large and volatile. Second, they display no significant serial correlation. Summary statistics for the weekly changes in the real-time estimates are reported in *Panel C*.”

Table 1: Summary Statistics							
	mean	max	skewness	Autocorrelations			
	Std.	min	kurtosis	ρ_1	ρ_2	ρ_4	ρ_8
A: Exchange Rate							
(i) Δs_t (x100)	-0.043	3.722	0.105	-0.061	0.027	0.025	-0.015
	1.234	-3.715	3.204	(0.287)	(0.603)	(0.643)	(0.789)
B: Order Flows							
(ii) Corporate US	-16.774	549.302	-0.696	-0.037	-0.040	0.028	-0.028
	108.685	-529.055	9.246	(0.434)	(0.608)	(0.569)	(0.562)
(iii) Corporate Non-US	-59.784	634.918	-0.005	0.072	0.089	-0.038	0.103
	196.089	-692.419	3.908	(0.223)	(0.124)	(0.513)	(0.091)
(iv) Traders US	-4.119	1710.163	0.026	-0.021	0.024	0.126	-0.009
	346.296	-2024.275	8.337	(0.735)	(0.602)	(0.101)	(0.897)
(v) Traders Non-US	11.187	972.106	0.392	-0.098	0.024	0.015	0.083
	183.36	-629.139	5.86	(0.072)	(0.660)	(0.747)	(0.140)
(vi) Investors US	19.442	535.32	-1.079	0.096	-0.024	-0.03	-0.016
	146.627	-874.15	11.226	(0.085)	(0.568)	(0.536)	(0.690)
(vii) Investors Non-US	15.85	1881.284	0.931	0.061	0.107	-0.030	-0.014
	273.406	-718.895	9.253	(0.182)	(0.041)	(0.550)	(0.825)
C: Real-Time Data							
(viii) US Output	-0.001	0.711	0.060	0.072	0.107	-0.015	0.058
	0.201	-0.610	0.134	(0.084)	(0.056)	(0.788)	(0.329)
(ix) US Prices	0.000	0.250	1.527	0.006	-0.034	0.091	0.004
	0.030	-0.104	18.673	(0.695)	(0.135)	(0.142)	(0.963)
(x) US Money	-0.007	5.679	-0.230	0.076	0.065	0.132	0.032
	1.368	-6.981	9.160	(0.003)	(0.012)	(0.131)	(0.595)
(xi) German Output	0.002	2.840	-0.298	0.072	-0.039	-0.009	0.019
	0.514	-4.087	20.437	(0.138)	(0.193)	(0.873)	(0.671)
(xii) German Prices	0.002	4.090	0.105	0.069	0.005	0.009	-0.044
	0.817	-3.988	8.632	(0.111)	(0.918)	(0.864)	(0.444)
(xiii) German Money	0.022	7.447	1.073	0.116	0.083	0.100	0.042
	1.421	-6.263	13.120	(0.000)	(0.000)	(0.339)	(0.473)
Notes: The table reports summary statistics for the following variables sampled at the weekly frequency between January 1993 and June 1999: (i) the weekly change in the log spot rate x100, (ii)-(vii) order flows from end-user segments cumulated over a week, and (viii)- (xiii) weekly changes in real-time estimates measured in annual percent. The last four columns on the right report autocorrelations ρ_i at lag i and p-values for the null that $\rho_i = 0$ in parentheses.							

Tab. 5. Summary statistics for weekly data (after *Evans, Lyons (2007)*).

Evans, Lyons (2007) draw the attention to an interesting fact: “Evans and Lyons (2002a,b) show that *order flows* account for between 40 and 80 percent of the daily variation in the spot exchange rates of major currency pairs.”

Evans, Lyons (2007) make the following conclusion: “We also showed that *proprietary transaction flows* have significant forecasting power for future exchange returns and that this forecasting power reflects their ability to predict how the market will react to the *flow of information* concerning macro fundamentals. ***In sum, we found strong support for the idea that exchange rates vary as the market assimilates dispersed information regarding macro fundamentals from transaction flows.***”

Finally, Evans, Lyons (2007) highlight a fact: “Most readers of this micro literature have adopted the same view: *Transaction flow effects* on exchange rates are about pricing errors, not about fundamentals. ***Our findings, by contrast, suggest that transaction flows are central to the process by which expectations of future macro variables are impounded into exchange rates.***”

The advanced research papers on the *order flow analysis technique* in the frames of the *theory of the foreign currencies exchange rates dynamics forecasting during the electronic trading process in the foreign currencies exchange markets and closely related scientific topics* have been written by a number of prominent scientists (*in the chronological order*) in Amihud, Ho, Schwartz (editors) (1985), Cohen, Conroy, Maier (1985), Hasbrouck, Ho (1987), Hasbrouck (1988), Taylor, Allen (1992), Sager, Taylor (2005, 2008), Evans, Lyons (1999, 2001a, 2002a, 2005d, 2006, 2007, 2009, 2010), Evans (2005, 2011), Saar (1999), Gehrig, Menkhoff (2000, 2004), Lyons (2001, 2003), Danielsson, Payne, Luo (2002), Danielsson, Payne (2011), Brandt, Kavajecz (2004), Breedon, Vitale (2004, 2010), Breedon, Rime, Vitale (2011), Love, Payne (2004), Marsh, O’Rourke (2005), Boyen, Van Norden (2006), Rime, Sarno, Sojli (2006, 2007, 2010), Berger, Chaboud, Chernenko, Howorka, Wright (2008), Frömmel, Mende, Menkhoff (2008), Lo, Sapp (2008, 2010), Dunne, Hau, Moore (2010), King, Sarno, Sojli (2010), Chinn, Moore (2011).

Most importantly, it is necessary to highlight the fact that some research problems on the *information aggregation* by the *foreign currencies traders* have been intuitively identified in Evans, Lyons (2007): “The *customer flows* forecast returns, because they are correlated with the future *market-wide information flow* that dealers use to revise their FX prices,” however this interconnection between the *information absorption* by the *foreign currencies traders* from the *foreign currencies exchange market* / the *fundamental economic indicators* and its influence on the trading strategy by the *foreign currencies traders* was not considered in details on that time.

Stratonovich-Kalman-Bucy filtering algorithm application in Stratonovich – Kalman – Bucy filter and particle filter to accurately estimate time series and predict trends in foreign currencies exchange rates dynamics during electronic trading in foreign currencies exchange markets.

In addition to the above listed *econometric models*, the prediction of the *trends in the foreign currencies exchange rates dynamics* in the frames of the *financial forecasting problem* can also be done, using the time series estimation techniques based on the *filtering theories* in the *econophysics*. After the formulation of the *Wiener filtering theory* in Wiener (1923, 1930, 1949), the various important research problems in the *Wiener filtering theory* have been researched in Ito (1944, 1951a, b, 2000). The *Pugachev filtering theory* has been outlined by Vladimir S. Pugachev in Pugachev (1944, 1956a, b, 1960, 1961, 1962, 1971, 1973, 1974, 1975, 1974, 1978, 1979a, b, 1980a, b, 1981, 1982a, b, 1984, 1985, 1986), Pugachev, Sinitsyn (1986, 1989, 1990, 1999, 2004), Pugachev, Sinitsyn, Shin (1986a, b, 1987a, b, c). The intensive research led to the creation of the *optimal non-linear filtering theory* in Stratonovich (1959a, b, 1960a, b, 1961, 1964, 1966), and the subsequent development of the *Stratonovich – Kalman – Bucy filtering algorithm* in Stratonovich (1959a, b, 1960a, b), Kalman, Koepcke (1958, 1959), Kalman, Bertram (1958, 1959), Kalman (1960a, b, 1963), Kalman, Bucy (1961). Let us cite a few sentences on the description of the *Stratonovich-Kalman-Bucy filtering algorithm* in Ledenyov D O, Ledenyov V O (2013g): “Analyzing the time series, Ruslan L. Stratonovich created *the optimal non-linear filtering theory* in 1959 in Stratonovich (1959a, b, 1960a, b). During next few years, the *optimal non-linear filtering theory* has been extensively complemented by the various research findings; and its foundational principles have been used to develop the *Stratonovich – Kalman – Bucy filtering algorithm* in 1959-1963 in Stratonovich (1959a, b, 1960a, b), Kalman, Koepcke (1958, 1959), Kalman, Bertram (1958, 1959), Kalman (1960a, b, 1963), Kalman, Bucy (1961).” In the process of the *financial forecasting problem* solution finding, the *Stratonovich-Kalman-Bucy filtering algorithm* can be applied to predict the *trends in the foreign currencies exchange rates dynamics* with a *greatly improved accuracy* during the *electronic trading process* in the *foreign currencies exchange markets*. The authors have already researched the *Stratonovich-Kalman-Bucy filtering algorithm*, *Stratonovich – Kalman – Bucy filters* and *particle filters* in Ledenyov D O, Ledenyov V O (2013g, h). Therefore, let us cite the definitions of the *Stratonovich – Kalman – Bucy filters* in Ledenyov D O, Ledenyov V O (2013h):

1. “*The Stratanovich – Kalman – Bucy filters* have been well described in *Ledenyov D O, Ledenyov V O (2013g)*: “The *Kalman filter*, also known as *Linear Quadratic Estimation (LQE)*, is an algorithm that uses a series of measurements observed over time, containing noise (random variations) and other inaccuracies, and produces estimates of unknown variables that tend to be more precise than those based on a single measurement alone. More formally, the *Kalman filter* operates recursively on streams of noisy input data to produce a statistically optimal estimate of the underlying system state.”

2. *The particle filters* have been accurately characterized in *Roncalli, Weisang (2008)*: “*Particle filtering methods* are techniques to implement recursive *Bayesian filters* using *Monte-Carlo simulations*. The key idea is to represent the posterior density function by a set of random samples with associated weights and to compute estimates based on these samples and weights [7, 20, 25, 26, 27, 28].”

Wolff (1987) published his research article titled: “*The forward foreign exchange rates, expected spot rates, and premia: A signal-extraction approach*,” proposing to apply a **state-space model** with the *Stratanovich-Kalman-Bucy filtering algorithm* to predict the risk premiums in the *foreign currencies exchange market*. Recently, *Yu, Fung, Hongyi (2005)* have discussed the possible *mathematical techniques* to evaluate the *exchange rate risk premiums* in *Hong Kong dollar*, using the **signal-extraction approach** for the research data analysis. Let us write a set of equations to describe the *signal-extraction approach* in *Yu, Fung, Hongyi (2005)*:

$$E_t(S_{t+1}) = f_t, \quad (1)$$

where $E_t(\dots)$ is the *conditional expectation*, based on information available at time t ; S and f are the *natural logarithm of the spot and forward exchange rates* respectively.

$$S_{t+1} = f_t + \varepsilon_{t+1} \quad (2)$$

where ε_{t+1} is the *rational expectation forecast error*: a *white-noise process with zero-mean*.

$$\Delta S_{t+1} = \alpha + \beta(f_t - S_t) + \varepsilon_{t+1} \quad (3)$$

where Δ is the *differencing operator*, and ΔS_{t+1} is defined as $S_{t+1} - S_t$.

$$f_t = E_t(S_{t+1}) + rp_t \quad (4)$$

$$f_t - S_{t+1} = rp_t + \eta_{t+1} \quad (5)$$

where η_{t+1} is the *expectation error*, it is assumed to be serially uncorrelated with zero-mean.

$$f_t^{t+m} - S_{t+m} = rp_{t,m} + \eta_{t+m} \quad (6)$$

where f_t^{t+m} is the *natural logarithm* of the *forward exchange rate* at time t for contracts delivered at m periods later, S_{t+m} is the *corresponding natural logarithm of spot exchange rate* at time $t+m$, $rp_{t,m}$ is equal to $f_t^{t+m} - E_t(S_{t+m})$, which is the *time-varying risk premium on forward contracts* for delivery at m periods later.

$$\eta_{t+m} = e_{t+m} + \theta_1 e_{t+m-1} + \theta_2 e_{t+m-2} \dots + \theta_{m-1} e_{t+1} \quad (7)$$

where $e_{t+j} \sim N(0, V)$, $j = 1, \dots, m$, i.e. e_{t+j} is assumed to distribute normally with mean zero and variance V .

$$rp_{t,m} = \sum_{i=1}^m \delta_i rp_{t-i,m} + \mu_{t,m} \quad (8)$$

$$\mu_{t,m} \sim N(0, U) \quad (9)$$

where η_{t+m} and $\mu_{t,m}$ are assumed to be independent for all t . *Yu, Fung, Hongyi (2005)* note that the equations (6) to (9) in the *state-space form* are estimated by *the maximum likelihood method* through the application of the *Kalman filter* in Tabs. 6, 7, 8, 9 and Figs. 32, 33.

Table 1. Autocorrelations (AC) and Partial Autocorrelations (PAC) of Excess Forward Return Series

		Excess forward return = $f_t^{t+m} - S_{t+m}$			
	Lag	m = 1-month	3-month	6-month	12-month
AC:	1	0.319	0.698	0.813	0.854
	2	0.303	0.571	0.718	0.774
	3	0.224	0.424	0.603	0.671
	4	0.111	0.297	0.476	0.569
	5	0.166	0.329	0.490	0.581
	6	0.071	0.294	0.439	0.534
PAC:	1	0.319	0.698	0.813	0.854
	2	0.224	0.162	0.165	0.165
	3	0.091	-0.046	-0.056	-0.084
	4	-0.035	-0.059	-0.122	-0.079
	5	0.089	0.234	0.332	0.370
	6	-0.023	0.018	-0.035	-0.069
Sample period from Jan 96 to		Aug 05	Jun 05	Mar 05	Sep 04

Notes: All series start from January 1996. Forward exchange rates and spot exchange rate are in natural logarithm.

Tab. 6. Autocorrelations (AC) and partial autocorrelations (PAC) of excess forward return series (after Yu, Fung, Hongyi (2005)).

Table 2. Estimation Results of State-Space Model

$$f_t^{t+m} - S_{t+m} = rP_{t,m} + \eta_{t+m},$$

$$\eta_{t+m} = e_{t+m} + \theta_1 e_{t+m-1} + \theta_2 e_{t+m-2} \dots + \theta_{m-1} e_{t+1}, \quad e_{t+j} \sim N(0, V), \quad j = 1, \dots, m$$

$$rP_{t,m} = \sum_{i=1}^m \delta_i rP_{t-i,m} + \mu_{t,m}, \quad \mu_{t,m} \sim N(0, U)$$

	Forward exchange rate for contracts delivered at				
	m =	1-month	3-month	6-month	12-month
δ_1		0.85*	0.88*	0.93*	0.96*
		(0.00)	(0.00)	(0.00)	(0.00)
V (x 10^{-6})		1.80*	5.02*	3.71	0.29
		(0.00)	(0.03)	(0.81)	(0.95)
U (x 10^{-6})		0.32	2.61	4.87	12.30
		(0.20)	(0.29)	(0.55)	(0.63)
Log-likelihood		584.19	503.54	446.15	372.06
Mean of rP (in percent)		0.02	0.07	0.21	0.66
Variance of rP (in percent)		0.01	0.09	0.24	0.99
Q(10)		7.07	15.53	10.49	2.43
Sample period from Jan 96 to		Aug 05	Jun 05	Mar 05	Sep 04
Observations		116	114	111	105

Notes: * indicates significant at the 5% confidence level. Figures in parentheses are p-values. All series start from January 1996. The estimated moving average parameters of the error terms are not reported. Forward exchange rates and spot exchange rate are in natural logarithm. Q(10) is the Ljung-Box Q-statistics based on the first ten serial correlation coefficients of the levels of standardised residuals. Q(10) is asymptotically distributed as a χ^2 with 10 degrees of freedom. The critical value of χ^2 (10) at the 5% confidence level is 18.31.

Tab. 7. Estimation results od state-space model (after Yu, Fung, Hongyi (2005)).

Chart 1. Estimated Risk Premiums of Hong Kong Dollar Forwards Contracts delivered at Different Horizons (1996-2005)

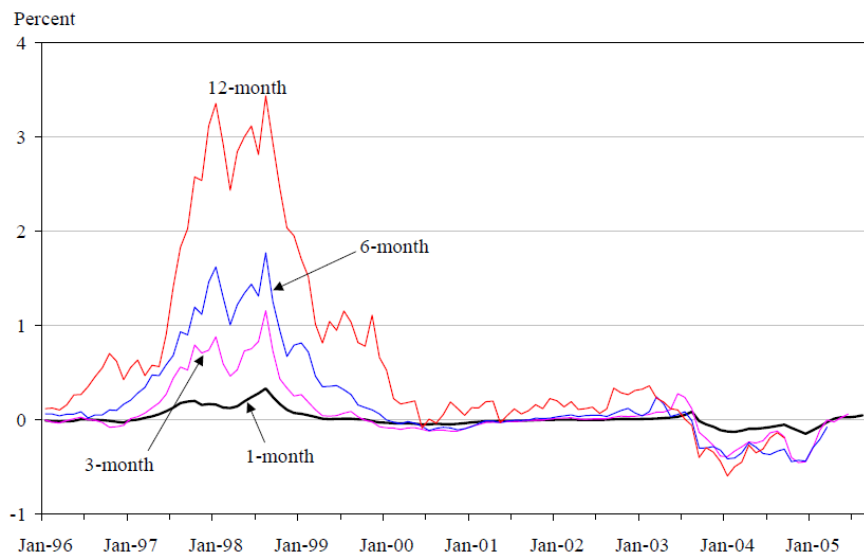

Fig. 32. Estimated risk premiums of Hong Kong dollar forwards contracts delivered at different horizons (after Yu, Fung, Hongyi (2005)).

Chart 2. Ex Post Excess Forward Returns and Estimated Risk Premiums

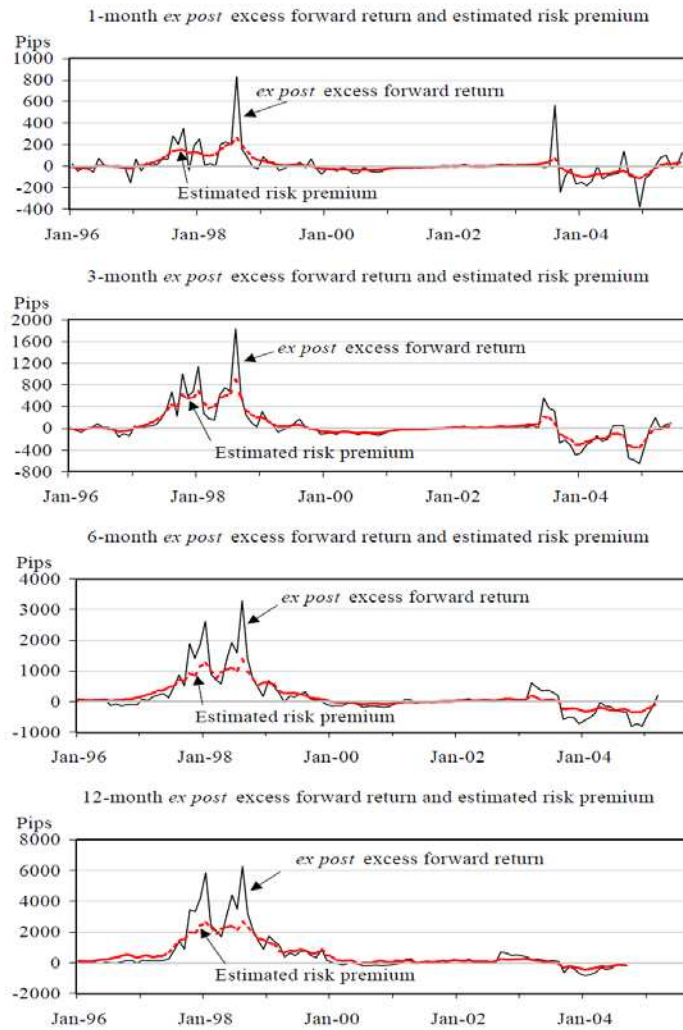

Fig. 33. Ex post excess forward returns and estimated risk premiums (after Yu, Fung, Hongyi (2005)).

Table 3. Out-of-Sample Forecast Errors

One-month Ahead Forecast errors based on		1-month	3-month	6-month	12-month
MSE (in pips)	State-space estimates of risk premiums	1.85	5.60	7.30	20.63
	Random Walk	1.23	4.10	3.90	4.60
MAE (in pips)	State-space estimates of risk premiums	101.48	182.76	205.11	399.14
	Random Walk	75.46	190.25	151.67	188.58

Notes: Numbers reported in the tables are mean squared errors (MSE) and mean absolute errors (MAE) of one-month ahead *ex ante* forecasts. The forecasting period is from October 2004 to September 2005.

Tab. 8. Out-of-Sample forecast errors (after Yu, Fung, Hongyi (2005)).

Table 4. Determinants of Risk Premiums

$$\Delta rP_{t,m} = C + \alpha \Delta \text{aggbal}_t + \beta \Delta \text{NDF}_{t,m} + \varepsilon_{t+m} + \phi_1 \varepsilon_{t+m-1} + \phi_2 \varepsilon_{t+m-2} + \dots + \phi_{m-1} \varepsilon_{t+1}$$

	Estimated risk premiums with delivery horizon <i>m</i> of			
	1-month	3-month	6-month	12-month
C (x 10 ⁻³)	-0.01 (0.81)	-0.01 (0.95)	-0.01 (0.85)	-0.08 (0.67)
Δaggbal_t (x 10 ⁻³)	-0.16* (0.00)	-0.23* (0.00)	-0.13* (0.03)	-0.53* (0.00)
$\Delta \text{NDF}_{t,1}$	-0.00 (0.78)	-	-	-
$\Delta \text{NDF}_{t,3}$	-	0.03* (0.00)	-	-
$\Delta \text{NDF}_{t,6}$	-	-	0.01* (0.00)	-
$\Delta \text{NDF}_{t,12}$	-	-	-	0.05* (0.00)
R-squared	0.21	0.47	0.62	0.53
Q(12)	10.64	5.79	13.84	5.47
Sample period From Jan 99	Aug 05	Jun 05	Mar 05	Sep 04
Observations	80	78	75	68

Notes: * indicates significant at the 5% confidence level. Figures in parentheses are p-values. All estimations start from January 1999. The estimated moving average parameters of the error terms are not reported. Q(12) is the Ljung-Box Q-statistics which is asymptotically distributed as a χ^2 with 12 degrees of freedom. The critical value of χ^2 (12) at the 5% confidence level is 21.03.

Tab. 9. Determinants of risk premium (after Yu, Fung, Hongyi (2005)).

As it can be seen in Yu, Fung, Hongyi (2005), the forward exchange rate can be viewed as the sum of two components: an *expected future spot rate* and a *time-varying risk premium*, hence it is possible to use the *signal-extraction approach* to identify and measure the *unobserved risk premiums* from the *Hong Kong dollar forward exchange rates*.

The most innovative research papers on the **Stratanovich-Kalman-Bucy filtering algorithm** and *closely related scientific topics* have been written by a number of well known scientists (in the chronological order) in Wiener (1923, 1930, 1949), Andronov, Vitt, Pontryagin (1933), Ito (1944, 1951a, b, 2000), Pugachev (1944, 1956a, b, 1960, 1961, 1962, 1971, 1973, 1974, 1975, 1974, 1978, 1979a, b, 1980a, b, 1981, 1982a, b, 1984, 1985, 1986), Pugachev, Sinitsyn (1986, 1989, 1990, 1999, 2004), Pugachev, Sinitsyn, Shin (1986a, b, 1987a, b, c), Shannon (1948), Bode, Shannon (1950), Zadeh, Ragazzini (1950), Booton (1952), Davis (1952),

Bartlett (1954), Doob (1955), Franklin (1955), Laning, Battin (1956), Lees (1956), Solodovnikov, Batkov (1956), Newton, Gould, Kaiser (1957), Tukey (1957), Rytov (1957), Cramer (1957), Bellman, Glicksberg, Gross (1958), Blum (1958), Darlington (1958), Davenport, Root (1958), Sherman (1958), Shinbrot (1958), Smith (1958), Kalman, Koepcke (1958, 1959), Kalman, Bertram (1958, 1959), Kalman R E (1960a, b, 1963), Kalman, Bucy (1961), Merriam (1959), Stratonovich (1959a b, 1960a, b, 1961, 1964, 1966), Volterra (1959), Middleton (1960), US Air Forces Office of Scientific Research (1960 – 2014), Friedman (1962), Busy (1967), Fisher (1967), Kushner (1964a, b, 1967a, b), Kushner, Budhiraja (2000), Liptser, Shiryaev (1968, 1974), Bryson, Ho (1969), Jazwinski (1970), Sorenson (1970), Bucy, Joseph (1970), Wright-Patterson Air Forces Base (AFB) (1970 – 2014), Chow, Lin (1971, 1976), Chow, Teicher (1978), Maybeck (1972, 1974, 1990), Willner (1973), Leondes, Pearson (1973), Akaike (1974), Athans (1974), Dempster, Laird, Rubin (1977), Griffiths (1977), Schwarz (1978), Falconer, Ljung (1978), Anderson, Moore (1979), Julier, Uhlmann (1997), Priestley (1981), Geweke, Singleton (1981), Fernandez (1981), Litterman (1983), Meinhold, Singpurwalla (1983), Ahlbehrendt, Kempe (1984), Harvey, Pierse (1984), Harvey (1987, 1989), Lewis (1986), Watson (1986), Lanning (1986), Burrige, Wallis (1988), Proakis, Manolakis (1988), Caines (1988), de Jong (1988, 1989, 1991), de Jong, Chu-Chun-Lin (1994), de Jong, Penzer (2004), Franklin, Powell, Workman (1990), Brockwell, Davis (1991), Jang (1991), Doran (1992), Brown, Hwang (1992, 1997), Gordon, Salmond, Smith (1993), Tanizaki (1993), Pinheiro, Coimbra (1993), Bar-Shalom, Xiao-Rong Li (1993), Farhmeir, Tutz (1994), Grimble (1994), Bomhoff (1994), Lee, Ricker (1994), Ricker, Lee (1995), Kleeman (1995), Venegas, de Alba, Ordorica (1995), Golub, van Loan (1996), Hayes (1996), Haykin (1996), Fuller (1996), Roncalli (1996), Wells (1996), Hodrick, Prescott (1997), Krelle (1997), Babbs, Nowman (1999), Kim, Nelson (1999), Pitt, Shephard (1999), Shiryaev (1999), Wanhammar (1999), Durbin, Koopman (2000, 2002, 2012), CuChe, Hess (2000), Ito, Xiong (2000), Doucet, de Freitas, Gordon (2001), Haykin (2001), Welch, Bishop (2001), Arulampalam, Maskell, Gordon, Clapp (2002), Javaheri, Lautier, Galli (2002), Doucet, Tadic (2003), Bahmani, Brown (2004), Broto, Ruiz (2004), Ristic, Arulampalam, Gordon (2004), Cappé, Moulines (2005), Ozbek, Ozale (2005), Poyiadjis, Doucet, Singh (2005a, b), Proietti (2006), Litvin, Konrad, Karl (2003), van Willigenburg, De Koning (2004), Voss, Timmer, Kurths (2004), Cappé, Moulines, Rydén (2005), Fernández-Villaverde, Rubio-Ramirez (2005, 2007), Fernández-Villaverde (2010), Frühwirth-Schnatter (2006), Pasricha (2006), Misra, Enge (2006), Gamerman, Lopes (2006), Pasricha (2006), Rajamani (2007), Bignasca, Rossi (2007), Andreasen (2008), Olsson, Cappé, Douc, Moulines (2008), Roncalli, Weisang (2008), Rajamani, Rawlings (2009), Bationo, Hounkpodote (2009), Chang, Miller, Park (2009),

Mapa, Sandoval, Yap (2009), Winschel, Kratzig (2010), Francke, Koopman, de Vos (2010), Luati, Proietti (2010), Theoret, and Racicot (2010), Xia, Tong (2011), Jungbacker, Koopman, van der Wel(2011), Moghaddam, Haleh, Ebrahimijam (2011), Darvas, Varga (2012), Hang Qian (2012), Proietti, Luati (2012a, b), Creal (2012), Matisko, Havlena (2012), Wikipedia (2014).

Ultra high frequency electronic trading strategies creation and execution under influence by discrete information absorption during ultra high frequencies electronic trading in foreign currencies exchange markets in diffusion - type global financial system with induced nonlinearities

The *winning virtuous strategies* creation and execution in the process of the *information-based electronic trading* in the *foreign currencies exchange market* results in an increase of the *return premium* for the *active traders* in Huang, Cai, Wang (2002). In agreement with the recent scientific findings in the research on the *strategy selection problems* in Porter (1979, 1980, 1982a, b, 1983, 1985, 1987a, b, 1991, 1994a, b, 1996a, b, 1997, 2001a, b, 2008, 2013), Porter, Harrigan (1981), Porter, Salter (1982), Montgomery, Porter (1991), Porter, Rivkin (2000), Porter, Sakakibara (2004), Anand, Bradley, Ghemawat, Khanna, Montgomery, Porter, Rivkin, Rukstad, Wells, Yoffie (2005), Porter, Kramer (2006), Grant (2001), Besanko, Shanley, Dranove (2007), Gavetti, Rivkin (2007), Teece, Winter (2007), Martin (1998-1999b, 2005-2006b); we think that the *winning virtuous trading strategies* can only be selected by the *traders* with the *highest information absorption capacity* through the *decision making process* on the *trading choices* during the *ultra high frequency electronic trading* in the *foreign currencies exchange markets* in the *diffusion - type global financial system* with the *induced nonlinearities*, applying the *econophysical econometrical analysis techniques* in Schumpeter (1906, 1933), Bowley (1924), Box, Jenkins (1970), Grangel, Newbold (1977), Van Horne (1984), Taylor S (1986), Tong (1986, 1990), Judge, Hill, Griffiths, Lee, Lutkepol (1988), Hardle (1990), Grangel, Teräsvirta (1993), Pesaran, Potter (1993), Banerjee, Dolado, Galbraith, Hendry (1993), Hamilton (1994), Karatzas, Shreve (1995), Campbell, Lo, MacKinlay (1997), Rogers, Talay (1997), Hayashi (2000), Durbin, Koopman (2000, 2002, 2012), Ilinski (2001), Greene (2003), Koop (2003), Davidson, MacKinnon (2004), Campbell, Lo, MacKinlay (1996) with the use of the *inductive, deductive and abductive logics* in Martin (1998-1999, 2005-2006) in the frames of the *strategic choice structuring process*, that is the *winning through the distinctive choices process* in Martin (1998-1999a, 2005-2006a, 2004, 2009), Moldoveanu, Martin (2001),

Lafley, Martin (2013), aiming both to get an *increased return premium* and to make a positive social impact in the local community and society in Foerster (2004), Hull (2005-2006).

Let us consider the factors, which can have an influence on the **information absorption capacity**, assuming that the **information** is a *valuable capital* in the hands of experienced financiers in 21st century in Shapiro, Varian (1999), and it can be thoroughly used in the *fundamental and technical models* of the *foreign currencies exchange rates determination* in Rosenberg (1996). First of all, let us explain that, in the process of the *information-based electronic trading* in the *foreign currencies exchange market*, there are the **information diffusion, absorption and dispersion processes**, which can precisely describe the *individual traders, trading firms, trading banks* on one side as well as to accurately characterize the *electronic trading systems, financial systems, foreign currencies exchange markets* on other side. The **information diffusion, absorption and dispersion processes** during the *ultra high frequency electronic trading* in the *foreign currencies exchange markets* in the *diffusion - type financial systems* with the *induced nonlinearities* have been researched by scientists. Franke, Hess (1997, 2000) investigated the problem of the **information diffusion** in the *electronic and floor trading*. Bacchetta, van Wincoop (2003) researched the **information dispersion** to explain the exchange rate disconnect puzzle. Evans, Lyons (2005b) researched one of the aspects of the **information absorption**: “Do currency markets absorb the news quickly?” De Zwart, Markwat, Swinkels, van Dijk (2009) considered the **economic value** of the **fundamental and technical information** in the *emerging currency markets*. Bjønnes, Osler, Rime (2011) researched the possible sources of the **information advantage** in the *foreign exchange currencies market*. Rime (2000) researched the **private and public information** in the *foreign currencies exchange markets*. Chinn, Moore (2008) researched a role of the **private information** in the *monetary model of exchange rates*. Moore, Payne (2011) identified the main sources of **private information** in the *foreign currencies exchange markets*. We assume that these **information diffusion, absorption and dispersion processes** are present during the *ultra high frequency electronic trading* in the *foreign currencies exchange markets* in the *diffusion - type financial systems* with the *induced nonlinearities*.

Continuing our research discussion on the **absorption phenomena in the econophysics**, which is researched in the frames of the **evolving learning process** at the various practical settings and theoretical considerations in the *econophysics* in the *finances*, we would like to say that a new perspective on the learning and innovation with the particular research focus on the **absorptive capacity** has been presented in Cohen, Levinthal (1990), Farina (2008), Hussinger (2010, 2012). There are a number of innovative studies, which have been focused on the

knowledge and information absorptive capacity by the firm in Farina (2008): “According to Cohen and Levinthal’s (1990) “*absorptive capacity*” concept, firms’ ability to get knowledge and information from their external environment is a function of the firms’ specialization choices and experiences. In particular, firms operating in many market segments are likely to possess more internal capabilities than firms operating in few market segments since, as the volume and complexity of information in the environment increase, the organization needs to have correspondingly high levels of information processing capacity (Miller and Chen (1994); Hambrick, (1982); Khandwalla (1973)).” Farina (2008) continues to explain: “In fact firms’ ability to use network ties for accessing information about opportunities and choices otherwise not available is depending on internal resource endowments and in particular on “*absorptive capacity*”.

Let us explain that, in a general case, we found that the *process of information absorption* by the *foreign currencies traders* (the *buyers* and *sellers*) is strongly affected by the constant presence of the *asymmetric information* streams in the *signaling information channels* between the *foreign currencies exchange markets agents* in the *foreign currencies exchange markets*, resulting in a fluctuating nature of the *foreign currencies exchange market* behaviour. It is necessary to point out that the *asymmetric information phenomena* in an application to the *automobile market* and some other markets has been researched for the first time in Akerlof (1970, 2014). The problem of *diverse information accumulation* by various markets agents has been raised in Grossman (1976). The problem of *impossibility of informationally efficient markets* has been considered in Grossman, Stiglitz (1980). The *problem of aggregation of information in the complete markets* has been studied in Hellwig (1980). The *information aggregation problem* in a noisy rational expectations economy has been considered in Diamond, Verrecchia (1981). The *information effects influence on the bid-ask spread in the foreign currencies exchange market* have been investigated in Copeland, Galai (1983). The *arrival of information and the reaction of traders* have been analyzed in French, Roll (1986). The *information intermediation from the foreign exchange market microstructure theory* point of view has been discussed to some degree in Lyons (1993a). The *price transmission and information asymmetry problems* have been highlighted in Shyy, Lee (1995). The *information content problem of the trading process* has been researched in Easley, Kiefer, O’Hara (1997a). The *asymmetric information and price discovery in the FX market* have been analyzed in Covrig, Melvin (1998). The *private information in the FX market* has been selected as a research topic in Ito, Lyons, Melvin (1998). The *asymmetric corporate exposures to the foreign exchange rate changes* have been uncovered in Miller, Reuer (1998). The *asymmetric information and the bid-*

ask spread in the FX market have been studied in Wang (1999). The *asymmetric information and inventory effects in the US treasury market* have been investigated in Brandt, Edelen, Kavajecz (2001). The *asymmetric exchange rate exposure problem* has been considered in Koutmos, Martin (2003). The *asymmetries in the bid and ask responses to the innovations in the trading process* have been found to exist in Escibano, Pascual (2006). The *problem of asymmetric information in the interbank foreign exchange market* has been discussed in Bjønnes, Osler, Rime (2007). The *limit-order submission strategies under the asymmetric information* have been described in Menkhoff, Osler, Schmeling (2010). The *sources of information advantage in the foreign exchange market* have been identified in Bjønnes, Osler, Rime (2011).

Let us state that, in our opinion, the *process of information absorption* by the *foreign currencies traders* can depend on:

1. The applied ***information coding techniques*** before the *information transmission* in the *signaling information channels* between the *foreign currencies exchange markets agents* in the *foreign currencies exchange markets* (the *information de-coding techniques* after the *information transmission*).
2. The applied ***information modulation techniques*** during the *information transmission* in the *signaling information channels* between the *foreign currencies exchange markets agents* in the *foreign currencies exchange markets*.
3. The applied ***transmitted information error correction techniques*** during the *information extraction* from the *signaling information channels* between the *foreign currencies exchange markets agents* in the *foreign currencies exchange markets*.

The above listed factors, including the *asymmetric information*, the *information coding (de-coding) techniques*, the *information modulation techniques*, the *information error correction techniques*, can make the multiple possible impacts on the following economic variables:

1. The ***time***, which is necessary by the *foreign currencies traders* to absorb the information during the *ultra high frequency electronic trading strategies creation and execution* under an influence by the *discrete information absorption* process during the *ultra high frequencies electronic trading* in the *foreign currencies exchange markets* in the *diffusion - type global financial system with the induced nonlinearities*.
2. The ***varying capacity by the foreign currencies traders to absorb the information*** during the *ultra high frequency electronic trading strategies creation and execution* under an influence by the *discrete information absorption* process during the *ultra high frequencies electronic trading* in the *foreign currencies exchange markets* in the *diffusion - type global financial system with the induced nonlinearities*.

3. The *changing ability by the foreign currencies traders to analyze the information* during the *ultra high frequency electronic trading strategies creation and execution* under an influence by the *discrete information absorption* process during the *ultra high frequencies electronic trading* in the *foreign currencies exchange markets* in the *diffusion - type global financial system with the induced nonlinearities*.

4. The *total time for the decision making process by the foreign currencies traders* during the *ultra high frequency electronic trading strategies creation and execution* under an influence by the *discrete information absorption* process during the *ultra high frequencies electronic trading* in the *foreign currencies exchange markets* in the *diffusion - type global financial system with the induced nonlinearities*.

We make a theoretical proposition that the trader's ability to select the winning virtuous strategies in the process of the information-based electronic trading in the foreign currencies exchange market strongly depends on the trader's information absorption capacity.

In our research approach, we assume that, in the process of *decision making process* on the *winning virtuous strategy*, the *traders* select the *winning virtuous strategies* by way of the *information absorption and its subsequent analysis* on an *available set of choices* in the frames of the *creative imperative integrative intelligent conceptual co-lateral adaptive logarithmic thinking process* with the application the *inductive, deductive and abductive logics* in *Martin (1998-1999, 2005-2006)* in the frames of the *strategic choice structuring process*, that is the *winning through the distinctive choices process* in *Martin (1998-1999a, 2005-2006a, 2004, 2009), Moldoveanu, Martin (2001), Lafley, Martin (2013)*. In other words, the *absorbed information* creates a *knowledge base*, which is necessary for the successful completion of *decision making process*. Let us remind the meanings of the ***deep knowledge*** and the ***broad knowledge*** as described in *Moldoveanu, Martin (2001)*: “The ***general knowledge*** – knowledge that can be easily taught and transferred by means of formalized dialects – and ***specific knowledge*** – knowledge that cannot be easily encoded and transferred. However, within each different kind of knowledge we can talk of a distinction between the depth of the knowledge and the breadth of the knowledge. ***Knowledge is deep when it is of the sort that can answer many concatenated ‘why?’ questions.*** The physicist’s and the mathematician’s knowledge are examples of deep knowledge. It has a hierarchical structure, with a few basic propositions at the top of the hierarchy, from which all other propositions follow by self-evident steps. ***Knowledge is broad when it can be used to answer many questions of the type: ‘what?’, ‘where?’, ‘who?’ and ‘how?’.*** The economist’s and the biologist’s knowledge are examples of ***broad knowledge***. There are few key fundamental; assumptions that can compress all of this knowledge, which

consists of a large set of empirical findings and basic causal mechanisms which only work when certain conditions come about.”

In the practical case of the *ultra high frequency electronic trading strategy creation and execution* processes in the *foreign currencies exchange markets* in the conditions of the *continuous and discrete information absorption processes* in the *diffusion - type global financial system* with the *induced nonlinearities*, the authors developed the software program, which performs the following computing routines:

1. The execution of the ***embedded optimized Stratanovich-Kalman-Bucy filtering algorithm*** and the ***embedded optimized particle filtering algorithm*** in the *Stratanovich – Kalman – Bucy filter* and the *particle filter* to accurately estimate the *time series* and predict the *trends in the foreign currencies exchange rates dynamics* under a possible influence by the *discrete information absorption processes* during the *ultra high frequencies electronic trading* in the *foreign currencies exchange markets* in the *diffusion - type global financial system* with the *induced nonlinearities*.
2. The execution of the ***embedded optimized macroeconomic analysis, market microstructure analysis and order flow analysis algorithms*** to precisely forecast the *foreign currencies exchange rates optional dynamics* under a possible influence by the *discrete information absorption processes* during the *ultra high frequencies electronic trading* in the *foreign currencies exchange markets* in the *diffusion - type global financial system* with the *induced nonlinearities*, using the *original information gathering and aggregation engines* from the computer servers.
3. The execution of the ***embedded optimized comparative analysis algorithm*** to compare the *obtained data streams* from the above completed algorithms in **1** and in **2**, to precisely forecast the *foreign currencies exchange rates optional dynamics* under a possible influence by the *discrete information absorption processes* during the *ultra high frequencies electronic trading* in the *foreign currencies exchange markets* in the *diffusion - type global financial system* with the *induced nonlinearities*.
4. The execution of the ***embedded optimized near real time artificial intelligence algorithm*** to numerically solve the *challenging research problem* on the *creation, selection and execution* of the *ultra high frequency electronic trading strategies* under a possible influence by the *discrete information absorption* during the *ultra high frequencies electronic trading* in the *foreign currencies exchange markets* in the *diffusion - type global financial system* with the *induced nonlinearities*. The *distinctive technical feature* of the developed *embedded optimized near-real-time artificial intelligence algorithm* is the application of the *inductive, deductive and*

abductive logics in Martin (1998-1999, 2005-2006) in the frames of the strategic choice structuring process, that is the winning through the distinctive choices process in Martin (1998-1999a, 2005-2006a, 2004, 2009), Moldoveanu, Martin (2001), Lafley, Martin (2013), during the numerical solution finding for the decision making problem on the winning virtuous strategy.

Thus, we developed the *MicroFX complex software platform* with the embedded optimized *Stratonovich - Kalman - Bucy filtering algorithm*, the *particle filtering algorithm*, the *macroeconomic analysis algorithm*, the *market microstructure analysis algorithm*, the *order flow analysis algorithm*, the *comparative analysis algorithm*; the *near-real-time artificial intelligence algorithm*, aiming both:

1) to accurately forecast the *trends in the foreign currencies exchange rates dynamics* during the *electronic trading process* in the *foreign currencies exchange markets* in the practical cases of the *non-Gaussian non-linear chaotic distributions* of the financial variables in the time domain in *Ledenyov D O, Ledenyov V O (2014c)*; and

2) to create, select and execute the *winning virtuous ultra high frequency electronic trading strategies* under a possible influence by the *discrete information absorption* during the *ultra high frequencies electronic trading* in the *foreign currencies exchange markets* in the *diffusion - type global financial system* with the *induced nonlinearities*.

The *MicroFX developed tested software program* can operate with the *commonly traded foreign currencies pairs* in the *foreign currencies exchange markets*, making the *quite accurate forecasts* on the *trends in the foreign currencies exchange rates dynamics* during the *electronic trading process* in the *selected foreign currencies exchange markets*.

The *increased accuracy of computations* by the *MicroFX software program* is reached by the application of a *combination of the prediction models*, including: the *econometric forecast models* from the *financial mathematics*; the *Stratanovich – Kalman – Bucy filtering algorithm estimation models* from the *space and nuclear physics*; the *particle filtering algorithm estimation models* from the *space and nuclear physics*; the *near-real-time artificial intelligence reasoning algorithm* from the *computer engineering*.

In the *US\$5.3tn-a-day foreign currencies exchange market*, the *authors* continue to use successfully the *MicroFX software program* with the aim to *create, select and execute the ultra high frequency electronic trading strategies* in the conditions, when there is the *discrete information absorption* during the *ultra high frequencies electronic trading* in the *foreign currencies exchange markets* in the *diffusion - type global financial system* with the *induced nonlinearities*.

In addition, the authors completed a *comparative technical analysis* of the main technical parameters of our *MicroFX software program* with some other known largest multibank trading systems: *State Street's FX Connect, FXall, 360 Trading Networks, Reuters Trading for FX, Thomson Reuters Matching, EBS, Currenex, Hotspot FX, Lava* as well as the *proprietary single bank foreign exchange currencies trading systems: Autobahn, FX Trader, BARX, Velocity, MorganDirect, REDI, SmartPrime, HSBCnet, FXHub, Prime, Trade FX, Passport* in Tabs. 10 and 11. As to the authors' best knowledge, the above listed *foreign exchange currencies trading software platforms* by the major dealing banks have the *early generation foreign exchange currencies trading software platforms architectures*, which don't use the *sophisticated algorithms* to estimate and forecast the *foreign exchange currencies rates trends* in the *near-real-time* conditions.

	Launched	Instruments that can be traded				
		Spot	Forwards	NDFs	Options	Swaps
a) Request-for-quote service						
State Street's FXConnect	1996	y				y
FXall	2001	y	y	y		y
360 Trading Networks	2002	y	y	y	y	y
Reuters Trading for FX	2005	y				y
b) Pre-trade anonymous limit order book						
Thomson Reuters Matching	1992	y	y	y	y	y
EBS	1993	y		y		
Currenex	1999	y				y
Hotspot FX	2000	y				
Lava	2001	y	y	y		y

Tab. 10. Overview of largest multibank trading systems for customers (after King, Osler, Rime (2011)).

	Share (%)	#Top 10
Deutsche Bank (Autobahn)	36	7
UBS (FX Trader)	22	7
Barclays Capital (BARX)	12	7
Citi (Velocity)	6	7
JPMorgan (MorganDirect)	3	3
Goldman Sachs (REDI)	3	5
RBS (SmartPrime)	3	6
HSBC (HSBCnet FXHub)	2	7
Credit Suisse (PrimeTrade FX)	2	3
Morgan Stanley (Passport)	2	2

Tab. 11. Average market share and years with top-10 ranking for single-bank platforms (after King, Osler, Rime (2011)).

Going to the next point, we also propose the ***Ledenyov law: The processing frequency of electronic trading systems in the foreign currencies exchange markets in the diffusion - type financial systems with the induced nonlinearities will double every two years***, which has been formulated in an analogy with the ***Moore's law***, which describes the integrated circuits capacity doubling every ***18 – 24*** months in ***Moore (1995, 2003)***.

Finally, we would like to make a few interesting concluding remarks that the *modern absorption theory* in the *finances and economics* as well as the *physics and chemistry* has been intensively developed by the *prominent distinguished researchers* at the *world class research institutions* and the *top league “red bricks” universities* in a number of countries over the recent centuries. In this connection, it makes sense to note a remarkable fact that the *nature of absorption processes* of the *different chemical compounds* in the *various physical – chemical systems* has been comprehensively researched by the *authors* together with their scientific collaborators in the fields of the *physics and chemistry* over the last 45 years. Let us list the selected theoretical and experimental research programs to study the *absorption phenomena* in the *material science*, which have been completed by the *authors* together with their scientific colleagues in recent decades:

1. The ***absorption of the different radioactive chemical elements and their isotopes in the soft condensed matter (the coal granules of different geometric shapes, the coal dust particles of micro- and nano- sizes) at the sound frequencies*** have been researched in the *nuclear physics* in *Ledenyov O P, Neklyudov (2013), Neklyudov, Dovbnaya, Dikiy, Ledenyov O P, Lyashko (2013), Neklyudov, Ledenyov O P, Fedorova, Poltinin (2013a, b), Neklyudov, Fedorova, Poltinin, Ledenyov O P (2013), Ledenyov O P, Neklyudov, Poltinin, Fedorova (2012a, b), Neklyudov, Ledenyov O P, Fedorova, Poltinin (2012), etc.*

2. The ***absorption of the electromagnetic signals in the condensed matter (the high pure metals and superconductors) at the ultrasonic frequencies*** has been investigated in the *solid state physics* at the in *Ledenyov O P (2012a, b, c), Ledenyov V O, Ledenyov D O, Ledenyov O P, Tikhonovsky (2012), Ledenyov O P, Fursa V P (2012), Shepelev, Ledenyov O P, Filimonov (2012a, b, c, d, e), etc.*

3. The ***absorption of the electromagnetic signals in the sub-surface layers in the condensed matter (the high temperature superconducting ceramics and dielectrics) at the ultra high frequencies*** has been studied in the *solid state physics* in *Ledenyov D O, Mazierska, Allen, Jacob (2012), Leong, Mazierska, Jacob, Ledenyov D O, Batt (2012), Mazierska, Ledenyov D O, Jacob, Krupka (2012), Jacob, Mazierska, Ledenyov D O, Krupka (2012), Mazierska, Krupka, Jacob, Ledenyov D O (2012), Jacob, Mazierska, Leong, Ledenyov D O, Krupka (2012), Jacob,*

Mazierska, Krupka, Ledenyov D O, Takeuchi (2012), Mazierska, Jacob, Ledenyov D O, Krupka (2012), Ledenyov D O (2013), Ledenyov D O, Ledenyov V O (2012e), Mazierska, Leong, Ledenyov, Rains, Zuchowski, Krupka (2014), etc.

Conclusion

In the *Schumpeterian creative disruption age*, the authors firmly believe that an increasing application of *electronic technologies* in the finances opens a big number of new unlimited opportunities toward the *ultra high frequency electronic trading* in the *foreign currencies exchange markets* in the conditions of the *discrete information absorption processes* in the *diffusion - type financial systems* with the *induced nonlinearities*.

This scientific paper applied the *innovative thinking* to research the *ultra high frequency electronic trading strategies* in the *foreign currencies exchange markets* in the conditions of the *discrete information absorption processes* in the *diffusion - type financial systems* with the *induced nonlinearities*, based on the academic literature.

Going from the academic literature, we discussed the *probability theory and the statistics theory application* to accurately characterize the trends in the *foreign currencies exchange rates dynamics* in the *short and long time periods*. We considered the *financial analysis methods*, including the *macroeconomic analysis, market microstructure analysis* and *transactions order flow analysis*, to forecast the *volatility* in the *foreign currencies exchange rates dynamics* in the *short and long time periods*.

We proposed to apply the *Stratanovich-Kalman-Bucy filtering algorithm* in the *Stratanovich – Kalman – Bucy filter* and the *particle filter* to accurately estimate the *time series* and predict the *trends* in the *foreign currencies exchange rates dynamics* in the *short and long time periods*.

We developed and tested the *MicroFX software program* with the *embedded optimized macroeconomic analysis, market microstructure analysis, order flow analysis, Stratanovich – Kalman – Bucy filtering, particle filtering, comparative analysis* and *artificial intelligence algorithms* with the purposes 1) to accurately forecast the *trends* in the *foreign currencies exchange rates dynamics* and 2) to create, select, execute the *winning virtuous strategies*, during the *ultra high frequency electronic trading* in the *foreign currencies exchange markets* in the conditions of the *discrete information absorption processes* in the *diffusion - type financial systems* with the *induced nonlinearities*, which take to the account the *non-Gaussian non-linear chaotic distributions* of the *financial variables* in the *time domain*.

We researched an *influence* by the *discrete information absorption* on the *ultra high frequency electronic trading strategies creation, selection and execution* during the *electronic trading in the foreign currencies exchange markets*.

We formulated the *Ledenyov law* on the *limiting frequency* (the *cut-off frequency*) for the *ultra high frequency electronic trading in the foreign currencies exchange markets*.

We believe that this paper extends our understanding of the complex research problems, connected with the *ultra high frequency electronic trading strategies in the foreign currencies exchange markets* in the conditions of the *discrete information absorption processes in the diffusion - type financial systems with the induced nonlinearities*.

We think that the application of the *multidisciplinary research skills* in the *finances, economics, econometrics, econophysics, electronics and computer science* will lead to the creation and execution of the *winning virtuous ultra high frequency electronic trading strategies in the foreign currencies exchange markets* in the conditions of the *discrete information absorption processes in the diffusion - type financial systems with the induced nonlinearities*.

Acknowledgement

This condensed *research article* is mainly aimed for the *young scientists, professors, subject experts, financial analytics, experienced financiers, foreign exchange traders and business leaders*, who would like to learn more on the *ultra high frequency electronic trading in the foreign exchange markets* at an influence by the *discrete information absorption processes in the diffusion – type financial systems with the induced nonlinearities*, and it is written, applying the *theoretical econometrical and econophysical approaches* in the academic literature. The research article is written on the basis of a series of invited lectures on the *ultra high frequency electronic trading in the foreign exchange markets* at an influence by the *continuous and discrete information absorption processes in the diffusion – type financial systems with the induced nonlinearities*, which has been presented by the *authors* at the leading universities around the *World* in recent years.

The *first author's* knowledge on the *origins of the nonlinearities* in the *complex systems* in the *electrical, electronic, computer and financial engineering* has been obtained during the intensive innovative scientific collaboration with *Prof. Janina E. Mazierska, Personal Chair, Electrical and Computer Engineering Department, James Cook University, Townsville, Australia* and *former Dean, Electrical and Computer Engineering Department, James Cook University, Townsville, Australia*, and *former IEEE Director Region 10 in Australia*, and *IEEE*

Fellow. The first author would like to acknowledge *Prof. Janina E. Mazierska* by expressing his sincere gratitude for the kind scientific advices on how to develop the *logical mathematical analysis skills*, the *scientific problems analytic solving ability* and the *abstract scientific thinking* to tackle the complex scientific problems on *the nonlinearities in the microwave superconductivity* as well as on *the nonlinearities in the finances*, applying the interdisciplinary scientific knowledge together with the advanced computer modeling techniques in the course of the cutting-edge highly innovative research projects at *James Cook University in Townsville in Queensland in Australia in 2000 – 2014* after the graduation from *V. N. Karazyn Kharkov National University in Kharkov in Ukraine in 1994 – 1999*.

There would be appropriate to say that, in an *information age*, the first author's special efforts have been primarily directed towards the *scientific information gathering, systematization and detailed analysis* in the frames of this research projects on the *ultra high frequency electronic trading in the foreign exchange markets* at an influence by the *discrete information absorption processes* in the *diffusion – type financial systems* with the *induced nonlinearities*; hence the *first author* would like to thank the professional staff at the *central library at James Cook University in Townsville, Queensland, Australia* for providing the *first author* with all the necessary technical support in relation to the literature search on the subjects of his multidisciplinary research interest in the national and international electronic research databases at *Australian universities*, replying to the numerous chaotic research requests timely, and making everything possible to assist with the completion of the highly innovative advanced research on the *ultra high frequency electronic trading in the foreign exchange markets* at presence of the *discrete information absorption processes* in the *diffusion – type financial systems* with the *induced nonlinearities* at the *James Cook University in Townsville, Queensland in Australia in 2000 – 2014*.

The *first author* would like to comment that the *informative scientific discussions* on the *accurate characterization of the foreign currencies exchange rates dynamics* during the *ultra high frequency electronic trading in the foreign currencies exchange markets* at an impact by the *discrete information absorption processes* in the *diffusion – type financial systems* with the *induced nonlinearities*, which have been conducted by the *first author* with the *M.Sc. students, Ph.D. candidates, professors, visiting scientists and other faculty members* during the numerous scientific seminars and research meetings at *James Cook University in Townsville in Queensland in Australia*, are generously appreciated, because these valuable scientific opinions exchanges encouraged the *first author* to generate the new original scientific ideas and make the *creative imperative integrative intelligent conceptual co-lateral adaptive logarithmic thinking* with the

application of the *inductive, deductive and abductive logics analysis* as far as the *ultra high frequency electronic trading in the foreign currencies exchange markets* is concerned.

A certain part of this condensed research article has been written during the first author's visit to the *City of Kuala Lumpur* and the *Island of Langkawi* (www.holidaylangkawi.com) in *Malaysia* in *January, 2014*. Therefore, it is a first author's great pleasure to see that the *6th London School of Economics Asia Forum 2014* has been also conducted in the *City of Kuala Lumpur, Malaysia* this year. It makes sense to comment that the *first author* did learn enormously from the research articles, written by *Prof. Charles A. E. Goodhart, London School of Economics and Political Science, London, UK*, who presented an *invited talk* at the above mentioned conference in *Malaysia* in *2014*. In addition, in the present research article, the *first author* decided to use the important research findings and the financial analysis data on the *global foreign currencies exchange market*, presented in the invited speech by *Prof. Andrew Sheng, Graduate School of Economics and Management, Tsinghua University, Beijing, P. R. China; the University of Malaya, Kuala Lumpur, Malaysia former President of Fung Global Institute, a Chief Adviser to the China Banking Regulatory Commission, a Board Member of Khazanah Nasional Berhad, Malaysia, a member of the International Advisory Panel to the Australian Treasury's Financial System Inquiry, and an advisor to the United Nations Environment Program Inquiry into the Design of a Sustainable Financial System*.

Summing up all the above comments, the *first author* acknowledges the “numerous meetings without the ties” with the great *Australian philosophers, professors, scientists, businessmen, lawyers, governmental officials and political leaders* in the relaxing trusted mutual-respect atmosphere, characterized by the pluralism of research opinions on the discussed topics, during the *Yara valley* and *Mornington-Peninsula limo tours* (www.yaravalleylimowinetours.com.au), which fascinated the *first author's* mind, stimulated the abstract thinking on the theoretical ideas or assumptions, and inspired to work consistently to complete the writing of this highly innovative condensed research article on the *ultra high frequency electronic trading in the foreign currencies exchange markets* in the case, when the *discrete information absorption processes* are present in the *diffusion – type financial systems* with the *various types of induced nonlinearities*, at *James Cook University in Townsville, Brisbane, and Gold Coast in Queensland in Australia* in *2014*.

The *second author* would like to kindly acknowledge the numerous private communications with the participants of the *V. Ya. Bunyakovsky international conference* with the special focus on the *V. Ya. Bunyakovsky's research contributions to the mathematical theory of probability* and its modern applications in the *econophysics and econometrics*, which had

place during a tour to the *Town of Bar, Vinnytsya Region, State of Ukraine* in the time of the conference, organized by the *Institute of Mathematics of National Academy of Sciences of Ukraine (NASU), Kyiv, Ukraine* on August 20 – 21, 2004. Absorbing the brilliant research ideas during a fruitful exchange by the scientific opinions among the conference attendees, the *second author* came up with a remarkable conclusion that the foundations of the *mathematical theory of probability* by *V. Ya. Bunyakovsky* enable us to perform a more accurate scientific analysis and characterization of the complex research problems on the *ultra high frequency electronic trading* in the *foreign currencies exchange markets* in the circumstances, when the *discrete information absorption processes* are present in the *diffusion – type financial systems* with the *various types of induced nonlinearities*. It makes sense to make a short note that this version of *research article* has been reviewed during the *second author's* visit to the *Town of Bar, Vinnytsya Region, State of Ukraine* in August, 2014.

It is a real pleasure to comment that some fundamental issues on the *electronic trading* in the *foreign currencies exchange markets* have been researched by the *second author* during his intensive research work on a number of the complex research problems at the *Electronic Trade Laboratory, Rotman School of Management, University of Toronto, Canada* in 2005 - 2006. Having said that, the *second author* would like to state that the *Electronic Trade Laboratory* at the *Rotman School of Management, University of Toronto, Canada* has become a *global hub of innovative scientific thinking* in the *finances* mainly due to the high level organizational efforts by *Prof. Roger L. Martin, former Dean, Rotman School of Management, University of Toronto, Canada* on that time. It is important to underline the fact that the *Electronic Trade Laboratory, Rotman School of Management, University of Toronto, Canada* can be characterized as a global financial center of gravity, where the highly innovative research work has been conducted by the *second author* from the early morning hours until the deep night, being occasionally interrupted by the thoughtful scientific discussions on a variety of problems in the finances with *Profs. John C. Hull and Roger L. Martin, Rotman School of Management, University of Toronto, Canada* in 2005 - 2006.

We are glad to mention a remarkable fact that the *authors* spent a great deal of time, analyzing the numerous mathematical formulas and research data by many distinguished scientists, and aiming to understand the *nature of the foreign currencies exchange rate dynamics*; hence we are very grateful to a big number of *distinguished professors* for their kind permissions to apply the *derived mathematical formulas* and *selected theoretical models* from their published research articles. Especially, the *authors* would like to acknowledge the extensive use of some important research results on the *macroeconomics analysis, market microstructure analysis and*

transactions order flow analysis methods in connection with the *foreign currencies exchange rates prediction problems* by *Richard K. Lyons*, *Bank of America Dean and Professor of Business* and *Kruttschnitt Family Chair in Financial Institution* at *Walter A. Haas School of Business* at *University of California-Berkeley* in *Berkeley, California* in the *USA*. In our opinion, the unconventional research thinking and brilliant scientific ideas on the *foreign currencies exchange rates dynamics* by *Prof. Richard K. Lyons* definitely deserve more focused research attention from the side of the *financiers, traders* and *professors* in the leading financial institutions and “red bricks” universities.

As always, we are very grateful to *Prof. Michael E. Porter*, *Bishop William Lawrence University Professor* and *former Dean of Harvard Business School, Harvard University*, who is considered by the authors as a *father of the modern business strategy*, for his valuable personal efforts and time to write a number of interesting informative research articles and books as well as to create the lecture notes, providing us with his professional expertise, exceptional quality professional advices and wise opinions in the field of *competitive strategy* in the *21st* century.

Playing the *tennis* at the *tennis courts* or the *golf* at the *golf play grounds* with our *research collaborators, business partners, friends* in various *developing and developed countries* around the *World* regularly, we have already conducted *many hundreds of thoughtful discussions on various research topics*, hence we would like to thank all our *global Friends* for their *brilliant ideas, interesting opinions, wise suggestions* and *shared experiences* on the *subject of our research interest* in the *finances*.

*E-mail: dimitri.ledenyov@my.jcu.edu.au

References:

Finances Science, Economics Science, Foreign Currencies Exchange Markets Science:

1. Joseph Penso de la Vega 1668, 1996 *Confusión de Confusiones* re-published by *John Wiley and Sons Inc* USA.
2. Mortimer Th 1765 *Every man his own broker* *4th edition* London UK.
3. Bagehot W 1873, 1897 *Lombard Street: A description of the money market* *Charles Scribner's Sons* New York USA.
4. von Böhm-Bawerk E 1884, 1889, 1921 *Capital and interest: History and critique of interest theories, positive theory of capital, further essays on capital and interest* Austria; 1890 *Macmillan and Co* edition Smart W A translator London UK
http://files.libertyfund.org/files/284/0188_Bk.pdf .

5. Bachelier L 1900 Theorie de la speculation *Annales de l'Ecole Normale Supérieure* Paris France vol **17** pp 21 – 86.
6. Schumpeter J A 1906 Über die mathematische methode der theoretischen ökonomie *ZfVSV* Germany.
7. Schumpeter J A 1933 The common sense of econometrics *Econometrica*.
8. Schumpeter J A 1911; 1939, 1961 Theorie der wirtschaftlichen entwicklung; The theory of economic development: An inquiry into profits, capital, credit, interest and the business cycle Redvers Opie (translator) *OUP* New York USA.
9. Schumpeter J A 1939 Business cycle *McGraw-Hill* New York USA.
10. Schumpeter J A 1947 The creative response in economic history *Journal of Economic History* vol **7** pp 149 – 159.
11. Slutsky E E 1910 Theory of marginal utility *M Sc Thesis* Vernadsky National Library Kiev Ukraine.
12. Slutsky E E 1912 Theory of correlation and elements of study about distribution curves *Kiev Commerce Institute Bulletin* **16** pp 1 – 208 Kiev Ukraine.
13. Slutsky E E 1913 On the criterion of goodness of fit of the regression lines and the best method of fitting them to the data *Journal Royal Statistics Society* vol **77** part I pp 78 – 84.
14. Slutsky E E 1914 Sir William Petty: Short overview of his economic visions with attachment of his several important research works *Kiev Commerce Institute Bulletin* **18** pp 5 – 48 Kiev Ukraine.
15. Slutsky E E 1915 Sulla teoria sel bilancio del consumatore *Giornale degli economisti e rivista di statistica* **51** no 1 pp 1 – 26 Italy.
16. Slutsky E E 1922a Statistics and mathematics. Review of Kaufman *Statistics Bulletin* **3 – 4** pp 104 – 120.
17. Slutsky E E 1922b To the question of logical foundations of probability calculation *Statistics Bulletin* **9 - 12** pp 13 – 21.
18. Slutsky E E 1923a On the some patterns of correlation connection and the systematic error of correlation coefficient *Statistics Bulletin* **1 – 3** pp 31 – 50.
19. Slutsky E E 1923b On a new coefficient of mean density of population *Statistics Bulletin* **4 – 6** pp 5 – 19.
20. Slutsky E E 1923c On calculation of state revenue from emission of paper money *Local Economy* **2** pp 39 – 62 Kiev Ukraine.
21. Slutsky E E 1925a On the law of large numbers *Statistics Bulletin* **7 – 9** pp 1 – 55.

22. Slutsky E E 1925b Ueber stochastische Asymptoten und Grenzwerte *Metron* Padova Italy vol **5** no 3 pp 3 – 89.
23. Slutski E E 1926 Ein Beitrag zur Formal-praxeologischen Grundlegung der Oekonomie *Ann de la classe des sci soc-econ* Akad Oukrainienne des Sciences Kiev Ukraine vol **4** pp 3 – 12.
24. Slutsky E E 1927a The summation of random causes as sources of cyclic processes *Problems of Conjuncture (Voprosy Kon'yunktury)* vol **3** issue 1 pp 34 – 64 Moscow Russian Federation.
25. Slutski E E 1927b Zur Kritik des Bohm-Bawerkschen Wertbegriffs und seiner Lehre von der Messbarkeit des Wertes *Schmollers Jb* **51** (4) pp 37 – 52.
26. Slutsky E E 1929 Sur l'erreur quadratique moyenne du coefficient de corrélation dans le cas des suites des épreuves non indépendantes *Comptes rendus* **189** pp 612 – 614.
27. Slutsky E E 1935 To the extrapolation problem in connection with forecast problem *Geophysics Journal* **5** (3) pp 263 – 277.
28. Slutsky E E 1937a Quelle proposition relative alla teoria delle funzioni aleatorie *Giornale dell Istituto Italiano degli Attuari* **8** no 2 pp 3 – 19.
29. Slutsky E E 1937b The summation of random causes as the source of cyclical processes *Econometrica* **5** pp 105 – 146.
30. Slutsky E E 1942, 1999 Autobiography of December 3, 1942 *Economics School* **5** pp 18 – 21.
31. Slutsky E E 1960 Selected research works (Izbrannye trudy) *Academy of Sciences of USSR* Moscow Russian Federation.
32. von Mises L 1912 The theory of money and credit Ludwig von Mises Institute Auburn Alabama USA http://mises.org/books/Theory_Money_Credit/Contents.aspx .
33. Hayek F 1945 The use of knowledge in society *American Economic Review* **35** pp 519 – 530.
34. Ellis H, Metzler L (editors) 1949 Readings in the theory of international trade *Blakiston* Philadelphia USA.
35. Machlup F 1949 The theory of foreign exchanges *in* Readings in the theory of international trade Ellis H, Metzler L (editors) *Blakiston* Philadelphia USA.
36. Robinson J 1949 The foreign exchanges *in* Readings in the theory of international trade Ellis H, Metzler L (editors) *Blakiston* Philadelphia USA.
37. Friedman M 1953 The case for flexible exchange rates *in* Essay in positive economics *University of Chicago Press* Chicago USA.
38. Friedman M (editor) 1953 Essays in positive economics *Chicago University Press* Chicago USA.

39. Baumol W 1957 Speculation, profitability, and stability *Review of Economics and Statistics* **39** pp 263 – 271.
40. Debreu G 1959 Theory of value *Cowles Foundation Monograph* vol **17** John Wiley & Sons Inc New York USA.
41. Shiryaev A N 1961 The problem of the most rapid detection of a disturbance in a stationary process *Soviet Mathematical Doklady* **2** pp 795 – 799.
42. Shiryaev A N 1963 On optimal methods in quickest detection problems *Theory of Probability and its Applications* **8** (1) pp 22 – 46.
43. Shiryaev A N 1964 On Markov sufficient statistics in non-additive Bayes problems of sequential analysis *Theory of Probability and its Applications* **9** (4) pp 670 – 686.
44. Shiryaev A N 1965 Some exact formulas in a 'disorder' problem *Theory of Probability and its Applications* **10** pp 348 – 354.
45. Grigelionis B I, Shiryaev A N 1966 On Stefan's problem and optimal stopping rules for Markov processes *Theory of Probability and its Applications* **11** pp 541 – 558.
46. Shiryaev A N 1967 Two problems of sequential analysis *Cybernetics* **3** pp 63 – 69.
47. Liptser R S, Shiryaev A N 1977 Statistics of random processes *Springer-Verlag* New York USA.
48. Shiryaev A N 1972 Random processes *Moscow State University Press* Russian Federation.
49. A. N. Shiryaev A N 1973, 1974 Probability, statistics, random processes *Moscow State University Press* vols **1, 2** Russian Federation.
50. Shiryaev A N 1978, 2008b Optimal stopping rules 1st edition, 3rd edition *Springer* ISSN 0172-4568 Library of Congress Control Number: 2007934268 Berlin Germany pp 1 – 217.
51. Shiryaev A N 1988 Probability *Springer-Verlag* Berlin Heidelberg Germany.
52. Shiryaev A N 1995 Probability 2nd edition *Springer - Verlag* ISBN 0-387-94549-0 New York USA pp 1 – 621.
53. Shiryaev A N 1998a Foundations of stochastic financial mathematics vol **1** *Fazis Scientific and Publishing House* Moscow Russian Federation ISBN 5-7036-0044-8 pp 1 – 492.
54. Shiryaev A N 1998b Foundations of stochastic financial mathematics vol **2** *Fazis Scientific and Publishing House* Moscow Russian Federation ISBN 5-7036-0044-8 pp 493 – 1017.
55. Shiryaev A N 1999 Essentials of stochastic finance: Facts, models, theory *Advanced Series on Statistical Science & Applied Probability* vol **3** *World Scientific Publishing Co Pte Ltd* Kruzhilin N (translator) ISBN 981-02-3605-0 Singapore pp 1 – 834.
56. Shiryaev A N, Spokoiny V G 2000 Statistical experiments and decisions: Asymptotic theory *World Scientific Publishing Co Pte Ltd* ISBN 9810241011 Singapore pp 1 – 283.

57. Graversen S E, Peskir G, Shiryaev A N 2001 Stopping Brownian motion without anticipation as close as possible to its ultimate maximum *Theory of Probability and its Applications* **45** pp 125 – 136 MR1810977 <http://www.ams.org/mathscinetgetitem?mr=1810977> .
58. Kallsen J, Shiryaev A N 2001 Time change representation of stochastic integrals *Theory of Probability and its Applications* **46** pp 579 - 585 MR1978671 <http://www.ams.org/mathscinet-getitem?mr=1978671> .
59. Kallsen J, Shiryaev A N 2002 The cumulant process and Esscher's change of measure *Finance Stoch* **6** pp 397 – 428 MR1932378 <http://www.ams.org/mathscinetgetitem?mr=1932378> .
60. Shiryaev A N 2002 Quickest detection problems in the technical analysis of the financial data *Proceedings Mathematical Finance Bachelier Congress Paris France (2000)* Springer Germany pp 487 – 521 MR1960576 <http://www.ams.org/mathscinet-getitem?mr=1960576> .
61. Jacod J, Shiryaev A N 2003 Limit theorems for stochastic processes *2nd edition* Grundlehren der Mathematischen Wissenschaften [Fundamental Principles of Mathematical Sciences] **288** Springer Berlin Germany MR1943877 <http://www.ams.org/mathscinetgetitem?mr=1943877> .
62. Shiryaev A N 2004 Kolmogorov and modern mathematics *International Conference at Mathematical Institute named after V A Steklov June 16-21, 2003* Russian Academy of Sciences Moscow Russian Federation ISBN 5-98419-003-6 pp 1 – 195.
63. Shiryaev A N, Grossinho M R, Oliveira P E, Esquivel M L (editors) 2006 Stochastic finance Springer Germany ISBN-10:0-387-28262-9 pp 1 – 364.
64. Peskir G, Shiryaev A N 2006 Optimal stopping and free-boundary problems *Lectures in Mathematics* ETH Zürich Birkhäuser Switzerland MR2256030 <http://www.ams.org/mathscinet-getitem?mr=2256030> .
65. Feinberg E A, Shiryaev A N 2006 Quickest detection of drift change for Brownian motion in generalized Bayesian and mini-max settings *Statistics & Decisions* **24** (4) pp 445 – 470.
66. Kabanov Yu, Lipster R, Stoyanov J 2006 The Shiryaev festschrift: From stochastic calculus to mathematical finance Springer Germany pp 1 – 668.
67. du Toit J, Peskir G, Shiryaev A N 2007 Predicting the last zero of Brownian motion with drift *Cornell University* NY USA pp 1- 17 <http://arxiv.org/abs/0712.3415v1> .
68. Shiryaev A N 2008a Generalized Bayesian nonlinear quickest detection problems: on Markov family of sufficient statistics *Mathematical Control Theory and Finance Proceedings of the Workshop of April 10–14 2007* Lisbon Portugal Sarychev A et al (editors) Springer Berlin Germany pp 377 – 386.

69. Eberlein E, Papantoleon A, Shiryaev A N 2008 On the duality principle in option pricing: Semimartingale setting *Finance Stoch* **12** pp 265 – 292
<http://www.ams.org/mathscinet-getitem?mr=2390191> .
70. Shiryaev A N, Novikov A A 2009 On a stochastic version of the trading rule "Buy and hold" *Statistics & Decisions* **26** (4) pp 289 – 302.
71. Eberlein E, Papantoleon A, Shiryaev A N 2009 Esscher transform and the duality principle for multidimensional semimartingales *The Annals of Applied Probability* vol **19** no 5 pp 1944 – 1971 <http://dx.doi.org/10.1214/09-AAP600> <http://arxiv.org/abs/0809.0301v5> .
72. Shiryaev A N, Zryumov P Y 2009 On the linear and nonlinear generalized Bayesian disorder problem (discrete time case) optimality and risk – modern trends in mathematical finance *The Kabanov Festschrift* Delbaen F et al (editors) Springer Berlin Germany pp 227 – 235.
73. Gapeev P V, Shiryaev A N 2010 Bayesian quickest detection problems for some diffusion processes *Cornell University NY USA* pp 1 – 25 <http://arxiv.org/abs/1010.3430v2> .
74. Karatzas I, Shiryaev A N, Shkolnikov M 2011 The one-sided Tanaka equation with drift *Cornell University NY USA*
<http://arxiv.org/abs/1108.4069v1> .
75. Shiryaev A N, Zhitlukhin M V 2012 Optimal stopping problems for a Brownian motion with a disorder on a finite interval *Cornell University NY USA* pp 1 – 10
<http://arxiv.org/abs/1212.3709v1> .
76. Zhitlukhin M V, Shiryaev A N 2012 Bayesian disorder detection problems on filtered probability spaces *Theory of Probability and Its Applications* **57** (3) pp 453 – 470.
77. Feinberg E A, Mandava M, Shiryaev A N 2013 On solutions of Kolmogorov's equations for nonhomogeneous jump Markov processes *Cornell University NY USA* pp 1 – 15
<http://arxiv.org/abs/1301.6998v3> .
78. Fama E F 1965 The behavior of stock market prices *Journal of Business* **38** pp 34 – 105.
79. Fama E F, Blume M 1966 Filter rules and stock market trading profits *Journal of Business* **39** pp 226 – 241.
80. Fama E F 1970 Efficient capital markets: A review of theory and empirical work *Journal of Finance* **25** (2) pp 383 – 417.
81. Fama E 1984 Forward and spot exchange rates *Journal of Monetary Economics* **14** pp 319 – 338.
82. Fama E, French K 1988 Permanent and temporary components of stock prices *Journal of Political Economy* **96** pp 246 – 273.

83. Fama E F, French K R 1996 Multifactor explanations of asset pricing anomalies *Journal of Finance* **51** (1) pp 55 – 84.
84. Fama E F 1998 Market efficiency, long-term returns, and behavioral finance *Journal of Financial Economics* **49** pp 283 – 306.
85. Fama E, Hansen L P, Shiller R 2013 Lectures: 2013 Nobel prize in economic sciences <http://www.youtube.com/watch?v=WzxZGvrpFu4> , www.nobelprize.org .
86. Demsetz H 1968 The cost of transacting *Quarterly Journal of Economics* **82** pp 33 – 53.
87. Radner R 1968 Competitive equilibrium under uncertainty *Econometrica* **36** pp 31 – 58.
88. Bates J M, Granger C W J 1969 The combination of forecasts *Operations Research Quarterly* **20** pp 451 – 468.
89. Akerlof G A 1970 The market for lemons: Qualitative uncertainty and the market mechanism *Quarterly Journal of Economics* **84** (3) pp 488 – 500.
90. Akerlof G A (29 August) 2014 Writing the "The Market for 'Lemons'": A Personal Interpretive Essay". Nobelprize.org. Nobel Media AB 2014. Web. 29 Aug 2014. http://www.nobelprize.org/nobel_prizes/economic-sciences/laureates/2001/akerlof-article.html?utm_source=facebook&utm_medium=social&utm_campaign=facebook_page
91. Arrow K 1970 Essays in the theory of risk bearing *Markham Chicago USA*.
92. Black F 1971 Toward a fully automated exchange *Financial Analysts Journal* **27** pp 29 – 35 and pp 86 – 87.
93. Black F, Scholes M 1973 The pricing of options and corporate liability *Journal of Political Economics* **81** pp 637 – 654.
94. Black F 1986 Noise *Journal of Finance* **41** (3) pp 529 – 543.
95. Merton R C 1973 Theory of rational option pricing *Bell Journal of Economics and Management Science* **4** pp 141 – 183.
96. Newbold P, Granger C W J 1974 Experience with forecasting univariate time series and the combination of forecasts *Journal of the Royal Statistical Society* **137** pp 131 – 165.
97. Fleming J M 1975 Floating exchange rates, asymmetrical intervention and the management of international liquidity *IMF Washington USA* <http://www.imf.org> .
98. Shapiro A C 1975 Exchange rate changes, inflation, and the value of the multinational corporation
99. Dooley M P, Shafer J R 1976 Analysis of short-run exchange rate behaviour: March 1973 to September 1975 *Federal Reserve Board International Finance Discussion Paper no 123* Federal Reserve Board USA.

100. Dornbusch R 1976 Expectations and exchange rate dynamics *Journal of Political Economy* **84** (6) pp 1161 – 1176.
101. Dornbusch R 1987 Exchange rates and prices *American Economic Review* **77** (1) pp 93 – 106.
102. Frankel J A 1976 A monetary approach to the exchange rate: Doctrinal aspects and empirical evidence *Scandinavian Journal of Economics* **78** pp 200 – 224.
103. Frankel J A 1979 On the mark: A theory of floating exchange rates based on real interest differentials *American Economic Review* **69** pp 610 – 622.
104. Frankel J A 1982a In search of the exchange risk premium: A six currency test assuming mean-variance optimization *Journal of International Money and Finance* **1** pp 255 – 274.
105. Frankel J A 1982b A test of perfect substitutability in the foreign exchange market *Southern Economic Journal* **49** pp 406 – 416.
106. Frankel J A (editor) 1983 Exchange rate and international macroeconomics *University of Chicago Press* Chicago USA.
107. Frankel J A, Froot K 1987 Using survey data to test standard propositions regarding exchange rate expectations *American Economic Review* **77** (1) pp 133 – 153.
108. Frankel J A, Froot K 1990a Chartists, fundamentalists, and trading in the foreign exchange market *American Economic Review* **80** pp 181 – 185.
109. Frankel J A, Froot K 1990b Chartists, fundamentalists, and the demand for dollars in Private behavior and government policy in interdependent economies Courakis A, Taylor M P *Clarendon* Oxford UK.
110. Frankel J A, Froot K 1990c Exchange rate forecasting techniques, survey data, and implications for the foreign exchange market *Working Paper no 3470* National Bureau of Economic Research Cambridge Massachusetts USA.
111. Frankel J A, Goldstein M, Mason P 1991 Characteristics of a successful exchange rate system *IMF* Washington USA <http://www.imf.org> .
112. Frankel J A 1992 In search of the exchange rate premium: A six-currency test assuming mean-variance optimization *Journal of International Money and Finance* **1**.
113. Frankel J A (editor) 1993 On exchange rates *MIT Press* Cambridge MA USA.
114. Frankel J A, Rose A K 1994 A survey of empirical research on nominal exchange rates *NBER Working Paper no 4865* NBER USA.
115. Frankel J A, Rose A 1995 Empirical research on nominal exchange rates in Handbook of international economics Grossman G, Rogoff K (editors) *Elsevier Science* vol **3** pp 1689 – 1729.

116. Frankel J A, Galli G, Giovannini A (editors) 1996 Introduction *in* The microstructure of foreign exchange markets *University of Chicago Press* Chicago USA ISBN: 0-226-26000-3 pp 1 – 15 <http://www.nber.org/books/fran96-1> , <http://www.nber.org/chapters/c11360> .
117. Frankel J A, Galli G, Giovannini A (editors) 1996 The microstructure of foreign exchange markets *University of Chicago Press* Chicago USA.
118. Frankel J A, Poonawala J 2004 The forward market in emerging currencies: Less biased than in major currencies *Working Paper* Harvard University USA.
119. Garman M 1976 Market microstructure *Journal of Financial Economics* **3** pp 257 – 275.
120. Grossman S 1976 On the efficiency of competitive stock markets when agents have diverse information *Journal of Finance* **31** pp 573 – 585.
121. Grossman S, Stiglitz J 1980 On the impossibility of informationally efficient markets *American Economic Review* **70** pp 393 – 408.
122. Grossman S, Miller M 1988 Liquidity and market structure *Journal of Finance* **43** pp 617 – 633.
123. Kouri P J K 1976 The exchange rate and the balance of payments in the short run and in the long run: A monetary approach *The Scandinavian Journal of Economics* **78** (2) pp 280 – 304.
124. McKinnon R 1976 Floating exchange rates, 1973-74: The emperor's new clothes *Carnegie-Rochester Conference Series on Public Policy* **3** pp 79 – 114.
125. Mussa M 1976 The exchange rate, the balance of payments, and monetary and fiscal policy under a regime of controlled floating *Scandinavian Journal of Economics* **78** pp 229 – 248.
126. Mussa M 1979 Empirical regularities in the behaviour of exchange rates and theories of the foreign exchange market *in* Brunner K, Meltzer A H (editors) Policies for employment, prices and exchange rates *Carnegie-Rochester Conference Series on Public Policy* **11** North-Holland Publishing Company Elsevier Amsterdam The Netherlands pp 9 – 57.
127. Mussa M 1981 The role of official intervention *Group of Thirty* New York NY USA.
128. Mussa M 1984 The theory of exchange rate determination *in* Exchange rates in theory and practice Bilson J, Marston R (editors) *University of Chicago Press* Chicago USA.
129. Williamson J 1976 Exchange rate flexibility and reserve use *Scandinavian Journal of Economics* **78** (2) pp 327 – 339.
130. Branson W 1977 Asset markets and relative prices in exchange rate determination *Sozialwissenschaftliche Annalen* **1** pp 69 – 89.

131. Branson W, Halttunen H, Masson P 1977 Exchange rates in the short run: The Deutschemark rate *European Economic Review* **10** pp 303 – 324.
132. Branson W, Henderson D 1985 The specification and influence of asset markets in Handbook of international economics vol **2** Jones R, Kenen P (editors) *North-Holland Publishing Company* Amsterdam The Netherlands.
133. Clark, Logue, Sweeney (editors) 1977 The effects of exchange rate adjustment *Department of the Treasury* Washington DC USA.
134. Girton L, Henderson D 1977 Central bank operations in foreign and domestic assets under fixed and flexible exchange rates in The effects of exchange rate adjustment Clark P, Logue D, Sweeney R (editors) *Department of the Treasury* Washington DC pp 151 – 179.
135. Cornell W B, Dietrich J K 1978 The efficiency of the market for foreign exchange under floating exchange rates *Review of Economics and Statistics* **60** (1) pp 111 – 120.
136. Cornell W B 1982 Money supply announcements, interest rates, and foreign exchange *Journal of International Money and Finance* **1** pp 201 – 208.
137. Stoll H R 1978 The supply of dealer services in securities markets *Journal of Finance* **33** pp 1133 – 1151.
138. Stoll H R 1985 The stock exchange specialist system: An economic analysis *Monograph Series in Finance and Economics: Monograph 1985-2* New York University NY USA.
139. Stoll H 1989 Inferring the components of the bid-ask spread: Theory and empirical tests *Journal of Finance* **44** pp 115 – 134.
140. Stoll H R 1995 The importance of equity trading costs: Evidence from securities firms' revenues in *Global equity markets: Technological, competitive, and regulatory challenges* Schwartz R (editor) *Irwin* Homewood Illinois USA pp 98 – 120.
141. Huang R, Stoll H 1996 Dealer versus auction markets: A paired comparison of execution costs on NASDAQ and the NYSE *Journal of Financial Economics* **41** pp 313 – 357.
142. Huang R, Stoll H 1997 The components of the bid-ask spread: A general approach *Review of Financial Studies* **10** pp 995 – 1034.
143. Stoll H R 1998 Reconsidering the affirmative obligation of market-makers *Financial Analysts Journal* **54** (5) pp 72 – 82.
144. Stoll H R, Schenzler Ch 2005 Trades outside the quotes: Reporting delay, trading option, or trade size? *Journal of Financial Economics*.
145. Stoll H R 2006 Electronic trading in stock markets *Journal of Economic Perspectives* **20** (1) pp 153 – 174.

146. Blanchard O 1979 Speculative bubbles, crashes, and rational expectations *Economics Letters* **14** pp 387 – 389.
147. Brunner K, Meltzer A H (editors) 1979 Policies for employment, prices and exchange rates *Carnegie-Rochester Conference Series on Public Policy* **11** North-Holland Publishing Company Elsevier Amsterdam The Netherlands.
148. Deardorff A 1979 One way arbitrage and its implications for the foreign exchange markets *Journal of Political Economy* **87** pp 351 - 364.
149. Goodman S 1979 Foreign exchange rate forecasting techniques: Implications for business and policy *The Journal of Finance* **34** pp 415 – 424.
150. Aliber R (October) 1980 The integration of the offshore and domestic banking system *Journal of Monetary Economics* vol **6** issue 4 pp 509 – 526.
151. Aliber R 2002 The new international money game 6th edition *University of Chicago Press* Chicago USA.
152. Allen P, Kenen P 1980 Asset markets, exchange rates, and economic integration *Cambridge University Press* New York USA.
153. Amihud Y, Mendelson H 1980 Dealership markets: Market making with inventory *Journal of Financial Economics* **8** pp 31 – 53.
154. Amihud Y, Ho T, Schwartz R (editors) 1985 Market making and the changing structure of the securities industry *Lexington* Massachusetts USA.
155. Amihud Y 1994a Evidence on exchange rates and valuation of equity shares *in* Exchange rates and corporate finance Amihud Y, Levich R M (editors) *Business One Irwin* Homewood IL USA.
156. Amihud Y 1994b Exchange rates and the valuation of equity shares *in* Exchange rates and corporate performance Amihud Y, Levich R M (editors) *Irwin* New York USA pp 49 – 59.
157. Amihud Y, Levich R M (editors) 1994 Exchange rates and corporate finance *Business One Irwin* Homewood IL USA.
158. Hansen L P, Hodrick R J 1980 Forward exchange rates as optimal predictors of future spot rates: An econometric analysis *Journal of Political Economy* **88** (5) pp 829 – 853.
159. Hellwig M 1980 On the aggregation of information in complete markets *Journal of Economic Theory* **26** pp 279 – 312.
160. Hellwig M 1982 Rational expectations equilibrium with conditioning on past prices: A mean-variance example *Journal of Economic Theory* **26** pp 279 – 312.

161. Krugman P 1980 Vehicle currencies and the structure of international exchange *Journal of Money, Credit, and Banking* **12** pp 503 – 526.
162. Krugman P 1984 The international role of the dollar: Theory and prospect in Exchange rate theory and practice Bilson J, Marston R (editors) *University of Chicago Press* Chicago USA pp 261 – 278.
163. Krugman P 1991 Target zones and exchange rate dynamics *Quarterly Journal of Economics* **106** (3) pp 669 – 682.
164. Krugman P, Miller M 1993 Why have a target zone? *Carnegie-Rochester Conference Series on Public Policy* **38** pp 279 – 314.
165. Krugman P 1999 The return of depression economics *W W Norton & Company* New York USA.
166. Callier P 1981 One way arbitrage, foreign exchange and securities markets: A note *Journal of Finance* **36** pp 1177 – 1186.
167. Cohen K, Maier S, Schwartz R, Whitcomb D 1981 Transaction costs, order placement strategy , and existence of the bid - ask spread *Journal of Political Economy* **89** (2) pp 287 – 305.
168. Cox J C, Ingersoll Jr J E, Ross S A 1981 The relation between forward and futures prices *Journal of Financial Economics* **9** pp 321 – 346.
169. Diamond D, Verrecchia R 1981 Information aggregation in a noisy rational expectations economy *Journal of Financial Economics* **9** pp 221 – 235.
170. Diamond D 1982 Aggregate demand management in search equilibrium *Journal of Political Economy* **90** pp 881 – 894.
171. Fieleke N (February) 1981 Foreign-currency positioning by US firms: Some new evidence *Review of Economics and Statistics* **63** no 1 pp 35 – 43.
172. Ho Th, Stoll H 1981 Optimal dealer pricing under transaction and return uncertainty *Journal of Financial Economics* **9** (1) pp 47 – 73.
173. Ho Th, Stoll H 1983 The dynamics of dealer markets under competition *Journal of Finance* **38** pp 1053 – 1074.
174. Loosignian A M 1981 Foreign exchange futures *Dow Jones - Irwin* Homewood IL USA.
175. Mussa M 1981 The role of official intervention *Group of Thirty* New York NY USA.
176. Stigum M 1981 Money market calculations: Yields, break - evens, and arbitrage *Dow Jones - Irwin* Homewood IL USA.
177. Stigum M 1990 The money market *Dow Jones - Irwin* Homewood IL USA.

178. Dooley M, Isard P 1982 A portfolio balance rational expectations model of the Dollar-Mark exchange rate *Journal of International Economics* **12** pp 257 – 276.
179. Hansen L 1982 Large sample properties of generalized method of moments estimators *Econometrica* **50** pp 1029 – 1054.
180. Hodder J E 1982 Exposure to foreign exchange-rate movements *Journal of International Economics* **13** (11) pp 375 – 386.
181. Milgrom P, Stokey N 1982 Information, trade and common knowledge *Journal of Economic Theory* **26** pp 17 – 27.
182. Taylor D 1982 Official intervention in the foreign exchange market, or, bet against the central bank *Journal of Political Economy* **90** (2) pp 356 – 368.
183. Bigman D, Taya T (editors) 1983 Exchange rate and trade instability *Ballinger Cambridge Massachusetts USA*.
184. Copeland T E, Galai D 1983 Information effects on the bid-ask spread *The Journal of Finance* **38** pp 1457 – 1469.
185. Dooley M P, Shafer J R 1983 Analysis of short-run exchange rate behaviour: March 1973 to November 1981 in Exchange rate and trade instability Bigman D, Taya T (editors) *Ballinger Cambridge Massachusetts USA* pp 43 - 69.
186. Edwards S 1983 The demand for international reserves and exchange rate adjustments: The case of LDCs, 1964–1972 *Economica* **50** pp 269 – 280.
187. French K R 1983 A comparison of futures and forward prices *Journal of Financial Economics* **12** pp 311 – 342.
188. Garman M B, Kohlhagen S W 1983 Foreign currency option values *Journal of International Money and Finance* **2** pp 231 – 237.
189. Meese R A, Rogoff K 1983a Empirical exchange rate models of the seventies: Do they fit out of sample? *Journal of International Economics* **14** pp 3 – 24.
190. Meese R A, Rogoff K 1983b The out-of-sample failure of empirical exchange rate models in Exchange rate and international macroeconomics Frankel J (editor) *University of Chicago Press Chicago USA*.
191. Rogoff K 1984 On the effects of sterilized intervention: An analysis of weekly data *Journal of Monetary Economics* **14** pp 133 – 150.
192. Rogoff K 1985 Can exchange rate predictability be achieved without monetary convergence? Evidence from the EMS *European Economic Review* **28** pp 93 – 115.
193. Meese R A 1986 Testing for bubbles in exchange markets *Journal of Political Economy* **94** pp 345 – 373.

194. Meese R A, Rogoff K 1988 Was it real? The exchange rate-interest differential relation of the modern floating-rate period *Journal of Finance* **43** pp 933 - 948.
195. Meese R A 1990 Currency fluctuations in the post-Bretton Woods era *Journal of Economic Perspectives* **4** pp 117 – 134.
196. Obstfeld M, Rogoff K 1995 Exchange rate dynamics redux *Journal of Political Economy* **103** pp 624 – 660.
197. Rogoff K 1996 The purchasing power parity puzzle *Journal of Economic Literature* **34** pp 647 – 668.
198. Obstfeld M, Rogoff K (August) 1998 Risk and exchange rates *NBER Working Paper 6694 NBER USA* in Helpman E, Sadka E (editors) Contemporary economic policy: Essays in honor of Assaf Razin *Cambridge University Press* Cambridge U.K.
199. Robinson P 1983 Nonparametric estimators for time series *Journal of Time Series Analysis* **4** pp 185 – 207.
200. Adler M, Dumas B 1984 Exposure to currency risk: Definition and measurement *Financial Management* **13** pp 41 – 50.
201. Backus D 1984 Empirical models of the exchange rate: Separating the wheat from the chaff *Canadian Journal of Economics* **17** pp 826 – 846.
202. Bilson J, Marston R (editors) 1984 Exchange rate theory and practice *University of Chicago Press* Chicago USA.
203. Booth L D 1984 Bid-ask spreads in the market for forward exchange *Journal of International Money and Finance* **3** (2) pp 209 – 222.
204. Engel Ch M, Frankel J A 1984a Why interest rates react to money announcements: An answer from the foreign exchange market *Journal of Monetary Economics* **13** pp 31 – 39.
205. Engel Ch M, Frankel J A 1984b Do asset demand functions optimize over the mean and variance of the real returns? A six-currency test *Journal of International Economics* **17**.
206. Engel Ch M, Hamilton J D 1990 Long swings in the dollar: Are they in the data and do markets know it? *American Economic Review* **80** pp 689 – 713.
207. Engel Ch M 1992 Can the Markov switching model forecast exchange rates? *NBER Working Paper no 4210* NBER USA.
208. Engel Ch M 1995 The forward discount anomaly and the risk premium: A survey of recent evidence *Technical Report 5312* National Bureau of Economic Research USA.
209. Engel Ch M 1996 The forward discount anomaly and the risk premium: A survey of recent evidence *Journal of Empirical Finance* **3** (2) pp 123 – 191.

210. Engel Ch M 1999 On the foreign exchange risk premium in sticky-price general equilibrium models *in* International finance and financial crises: Essays in honor of Robert P. Flood Isard P, Razin A, Rose A (editors) *IMF and Kluwer* The Netherlands.
211. Devereux M, Engel Ch M 1999 The optimal choice of exchange-rate regime: Price setting rules and internationalized production *NBER Working Paper 6992* NBER USA.
212. Devereux M B, Engel Ch M 2002 Exchange rate pass-through, exchange rate volatility, and exchange rate disconnect *Journal of Monetary Economics* **49** pp 913 – 940.
213. Devereux M B, Shi S 2005 Vehicle currency *Working Paper* University of British Columbia Vancouver Canada <http://www.econ.ubc.ca/devereux/vc2.pdf> .
214. Engel Ch M, West K (May) 2004a Accounting for exchange rate variability in present value models when the discount factor is near one *American Economic Review* **94** pp 118 – 125.
215. Engel Ch M, West K (August) 2004b, 2005 Exchange rates and fundamentals *Working Paper 10723* NBER USA, *Journal of Political Economy* **113** pp 485 – 517.
216. Engel Ch M, West K D 2006 Taylor rules and the Deutschmark - Dollar real exchange rate *Journal of Money, Credit, and Banking* **38** (5) pp 1175 – 1194.
217. Engel Ch M, Mark N, West K D 2007 Exchange rate models are not as bad as you think *NBER Working Paper* NBER USA.
218. Garner C K, Shapiro A C 1984 A practical method of assessing foreign exchange risk *Midland Corporate Finance Journal* pp 6 – 17.
219. Loopesko B 1984 Relationships among exchange rates, intervention, and interest rates: An empirical investigation *Journal of International Money and Finance* **3** pp 257 – 277.
220. Roll R 1984 A simple implicit measure of the effective bid - ask spread in an efficient market *The Journal of Finance* **39** pp 1127 – 1139.
221. French K, Roll R 1986 Stock return variances: The arrival of information and the reaction of traders *Journal of Financial Economics* **17** pp 5 – 26.
222. Roll R 1988 R^2 *Journal of Finance* **43** pp 541 – 566.
223. Urich T, Watchel P 1984 The effects of inflation and money supply announcements on interest rates *Journal of Finance* **39** pp 1177 – 1188.
224. White H, Domowitz I 1984 Nonlinear regression with dependent observations *Econometrica* **52** (1) pp 143 – 161.
225. Bahmani-Oskooee M, Das S 1985 Transaction costs and the interest parity theorem *Journal of Political Economy* **93** pp 793 – 799.

226. Cohen K, Conroy R, Maier S 1985 Order flow and the quality of the market *in* Market making and the changing structure of the securities industry Amihud Y, Ho T, Schwartz R (editors) *Lexington Massachusetts USA*.
227. Glosten L R, Milgrom P (March) 1985 Bid, ask, and transaction prices in a specialist market with heterogeneously informed agents *Journal of Financial Economics* **14** pp 71 – 100.
228. Glosten L R, Harris L 1988 Estimating the components of the bid - ask spread *Journal of Financial Economics* **21** pp 123 – 142.
229. Glosten L R 1989 Insider trading, liquidity, and the role of the monopolist specialist *Journal of Business* **62** (2) pp 211 – 235.
230. Glosten L R 1994 Is the electronic open limit order book inevitable? *Journal of Finance* **49** pp 1127 – 1162.
231. Hakkio C, Pearce D 1985 The reaction of exchange rates to economic news *Economic Inquiry* **23** pp 621 – 635.
232. Hardouvelis G A 1985 Exchange rates, interest rates, and money-stock announcements: A Theoretical exposition *Journal of International Money and Finance* **4** pp 443 – 454.
233. Jones R, Kenen P (editors) 1985 Handbook of international economics *North-Holland Publishing Company Amsterdam The Netherlands*.
234. Kearney C, Macdonald R 1985 Intervention and sterilization under floating exchange rates: The UK 1973-1983 *European Economic Review* **30**.
235. Kyle A 1985 Continuous auctions and insider trading *Econometrica* **53** pp 1315 – 1335.
236. Kyle A 1989 Informed speculation with imperfect competition *Review of Economic Studies* **56** pp 317 – 356.
237. Kyle A, Xiong W 2001 Contagion as a wealth effect *Typescript Duke University North Carolina USA*.
238. Levich R M 1985 Empirical studies of exchange rates: Price behaviour, rate determination and market efficiency *in* Handbook of international economics Jones R W, Kenen P B (editors) vol **2** *North-Holland Publishing Company Amsterdam The Netherlands*.
239. McInish T H, Wood R A 1985 An analysis of transactions data for the Toronto Stock Exchange *The Journal of Banking and Finance* **14** pp 441 – 458.
240. Dominguez K M 1986 Are foreign exchange forecasts rational? New evidence from survey data *Economic Letters* **21** pp 277 – 281.
241. Dominguez K M 1990 Market responses to coordinated central bank intervention *Carnegie-Rochester Series on Public Policy* **32** pp 121 – 163.

242. Dominguez K M 1992 Exchange rate efficiency and the behavior of international asset markets *Garland* New York USA.
243. Dominguez K M 1993 Does central bank intervention increase the volatility of foreign exchange rates? *Technical Report 4532* National Bureau of Economic Research Cambridge MA USA.
244. Dominguez K M, Frankel J 1993a Does foreign-exchange intervention matter? The portfolio effect *American Economic Review* **83** (5) pp 1356 – 1369.
245. Dominguez K M, Frankel J 1993b Does foreign-exchange intervention work? *Institute for International Economics* Washington DC USA.
246. Dominguez K M, Frankel J A 1993c Foreign exchange intervention: An empirical assessment in *On exchange rates* Frankel J A (editor) *MIT Press* Cambridge MA USA.
247. Dominguez K M 1998 Central bank intervention and exchange rate volatility *Journal of International Money and Finance* **18** pp 161 – 190.
248. Dominguez K M 2003a The market microstructure of central bank intervention *Journal of International Economics* **59** pp 25 – 45.
249. Dominguez K M 2003b Foreign exchange intervention: Did it work in the 1990s? in *Dollar overvaluation and the World economy* Bergsten C F, Williamson J (editors) *Institute for International Economics* Washington DC USA.
250. Bollerslev T 1986 Generalized autoregressive conditional heteroskedasticity *Journal of Econometrics* **21** pp 307 – 328.
251. Baillie R, Bollerslev T 1989 The daily message in exchange rates: A conditional variance tale *Journal of Business and Economic Statistics* **7** pp 297 – 305.
252. Baillie R, Bollerslev T 1990 Intra-day and inter market volatility in foreign exchange rates *Review of Economic Studies* **58** pp 565 – 585.
253. Bollerslev T 1990 Modeling the coherence in short-run nominal exchange rates: A multivariate generalized ARCH model *Review of Economics and Statistics* **72** pp 498 – 595.
254. Bollerslev T, Chou R Y, Jayaraman N, Kroner K F 1990 ARCH modeling in finance: A review of the theory and empirical evidence *Journal of Econometrics* **52** (1) pp 5 – 60.
255. Bollerslev T, Domowitz I 1991 Price volatility, spread variability and the role of alternative market mechanisms *Review of Futures Markets* **10** pp 78 – 102.
256. Baillie R T, Bollerslev T 1991 Intra - day and inter - market volatility in foreign exchange rates *Review of Economic Studies* **58** pp 565 – 585.
257. Bollerslev T, Domowitz I (September) 1993 Trading patterns and prices in the interbank foreign exchange market *Journal of Finance* **48** (4) pp 1421 – 1443.

- 258.** Bollerslev T, Melvin M 1994 Bid - ask spreads and volatility in the foreign exchange market: An empirical analysis *Journal of International Economics* **36** pp 355 – 372.
- 259.** Andersen T, Bollerslev T 1994 Intraday seasonality and volatility persistence in foreign exchange and equity markets *Working Paper no 186* Department of Finance Northwestern University USA.
- 260.** Bollerslev T, Engle R F, Nelson D B 1995 ARCH models *in Handbook of econometrics* vol **4** *North-Holland Publishing Company* New York USA.
- 261.** Andersen T, Bollerslev T 1998 Deutsche mark-dollar volatility: Intraday activity patterns, macroeconomic announcements, and longer run dependencies *Journal of Finance* **53** pp 219 – 266.
- 262.** Bollerslev T, Cai J, Song F 2000 Intraday periodicity, long-memory volatility, and macroeconomic announcement effects in the US treasury bond market *Journal of Empirical Finance* **7** pp 37 – 55.
- 263.** Andersen T G, Bollerslev T, Diebold F X, Labys P 2000 Exchange rate returns standardized by realized volatility are (nearly) Gaussian *Multinational Finance Journal* **4** pp 159 – 179.
- 264.** Andersen T, Bollerslev T, Diebold F, Vega C (September) 2001, 2003 Micro effects of macro announcements: Real-time price discovery in foreign exchange *Typescript* Northwestern University USA; *American Economic Review* **93** pp 38 – 62.
- 265.** Andersen T, Bollerslev T, Diebold F X, Labys P 2001 The distribution of realized exchange rate volatility *Journal of the American Statistical Association* **96** (453) pp 42 – 55.
- 266.** Andersen T G, Bollerslev T, Diebold F X, Labys P 2003 Modeling and forecasting realized volatility *Econometrica* **71** pp 579 - 625.
- 267.** Andersen T G, Bollerslev T, Diebold F X 2007 Roughing it up: Including jump components *in The measurement, modeling and forecasting of return volatility* *Review of Economics and Statistics* **89** pp 701 – 720.
- 268.** Engle R F 1982 Autoregressive conditional heteroskedasticity with estimates of the variance of United Kingdom inflation *Econometrica* **50** pp 987 – 1007.
- 269.** Engle R F, Bollerslev T 1986 Modeling the persistence of conditional variance *Econometrics Reviews* **5** pp 1 – 50.
- 270.** Engle R F, Granger C 1987 Cointegration and error correction: Representation, estimation and testing *Econometrica* **55** pp 251 – 276.
- 271.** Engle R F, Rodriguez A P 1989 Tests of international CAPM with time varying covariances *Journal Of Applied Econometrics* **4**.

272. Engle R F, Ito T, Lin Wen-Ling 1990 Meteor showers or heat waves? Heteroskedastic intra-daily volatility in the foreign exchange market *Econometrica* **58** pp 525 – 542.
273. Engle R F, Russell J R 1995 Forecasting transaction rates: The autoregressive conditional duration model *Proceedings of the First International Conference on High Frequency Data in Finance (HFDF-1)* vol **4** Research Institute for Applied Economics Olsen & Associates Zürich Switzerland.
274. Engle R F, Gallo G M 2006 A multiple indicators model for volatility using intra-daily data *Journal of Econometrics* **131** pp 3 – 27.
275. Evans G 1986 A test for speculative bubbles in the sterling-dollar exchange rate *American Economic Review* **76** pp 621 – 636.
276. Flood E Jr, Lessard D R 1986 On the measurement of operating exposure to exchange rates: A conceptual approach *Financial Management* **15** pp 25 – 37.
277. Grammatikos T, Saunders A, Swary I 1986 Returns and risks of US Bank foreign currency activities *Journal of Finance* **41** (3) pp 671 – 682.
278. Harris L 1986 A transaction data survey of weekly and intraday patterns in stock returns *Journal of Financial Economics* **16** pp 99 – 117.
279. Harris L 1990 Statistical properties of the roll serial covariance bid/ask spread estimator *Journal of Finance* **45** pp 579 – 590.
280. Hart O D, Kreps D M 1986 Price destabilizing speculation *Journal of Political Economy* **94** pp 927 – 952.
281. Lyons R K 1986 Tests of the foreign exchange risk premium using the expected second moments implied by option pricing *International Finance Discussion Papers 290* Board of Governors of the Federal Reserve System USA.
282. Lyons R K (March) 1988 Tests of the foreign exchange risk premium using the expected second moments implied by option pricing *Journal of International Money and Finance Elsevier* **7** (1) pp 91 – 108.
283. Lyons R K (November) 1990 Whence exchange rate overshooting: Money stock or flow? *Journal of International Economics Elsevier* **29** (3 - 4) pp 369 – 384.
284. Lyons R K 1991 Private beliefs and information externalities in the foreign exchange market *NBER Working Papers 3889* National Bureau of Economic Research Inc.
285. Lyons R K (January) 1992 Floating exchange rates in Peru, 1950-1954 *Journal of Development Economics Elsevier* **38** (1) pp 99 – 118.
286. Lyons R 1993a Information intermediation in the microstructure of the foreign exchange market *NBER Working Paper #3889* Berkeley Business School USA.

287. Lyons R 1993b Tests of microstructural hypothesis in the foreign exchange market *NBER Working Paper #4471* Berkeley Business School USA.
288. Lyons R K 1993c Optimal transparency in a dealership market with an application to foreign exchange *NBER Working Papers 4467* National Bureau of Economic Research Inc.
289. Baldwin R E, Lyons R K (January) 1994 Exchange rate hysteresis? Large versus small policy misalignments *European Economic Review Elsevier* **38** (1) pp 1 – 22.
290. Lyons R 1994 Foreign exchange volume: Sound and fury signifying nothing? *Berkeley Business School* USA.
291. Lyons R K 1995 Tests of microstructural hypotheses in the foreign exchange market *Journal of Financial Economics Elsevier* **39** (2 - 3) pp 321 – 351.
292. Lyons R K, Rose A K (September) 1995 Explaining forward exchange bias . . . intraday *Journal of Finance American Finance Association* **50** (4) pp 1321 – 1329.
293. Lyons R K 1996a Foreign exchange volume: Sound and fury signifying nothing? in *The microstructure of foreign exchange markets National Bureau of Economic Research Inc* pp 183 – 208.
294. Lyons R K (July) 1996b Optimal transparency in a dealer market with an application to foreign exchange *Journal of Financial Intermediation Elsevier* **5** (3) pp 225 – 254.
295. Lyons R K 1997a Explaining trading volume in foreign exchange: Lessons from Tokyo *FRBSF Economic Letter* Federal Reserve Bank of San Francisco issue December 26.
296. Lyons R K (May) 1997b A simultaneous trade model of the foreign exchange hot potato *Journal of International Economics Elsevier* **42** (3 - 4) pp 275 – 298.
297. Lyons R K 1997c Profits and position control: A week of FX dealing *Research Program in Finance Working Papers RPF-273* University of California at Berkeley.
298. Lyons R K (February) 1998a Profits and position control: A week of FX dealing *Journal of International Money and Finance Elsevier* **17** (1) pp 97 – 115.
299. Lyons R K (December) 1998b Introduction to the international market microstructure issue *Journal of International Financial Markets, Institutions and Money Elsevier* **8** (3 - 4) pp 219 – 223.
300. Lyons R K (Summer) 2001 New perspective on FX markets: Order-flow analysis *International Finance Wiley Blackwell* **4** (2) pp 303 – 320.
301. Fan M, Lyons R (July) 2001 Customer-dealer trading in the foreign exchange market *Typescript* UC Berkeley USA.
302. Killeen W, Lyons R, Moore M (September) 2001 Fixed versus flexible: Lessons from EMS order flow *NBER Working Paper 8491* NBER USA.

- 303.** Killeen W, Hau H, Moore M 2001 The euro as an international currency: Explaining puzzling first evidence from the foreign exchange markets *Journal of International Money and Finance*.
- 304.** Lyons R K (October) 2002 Theoretical perspective on euro liquidity *Economic Policy* CEPR & CES & MSH **17** (35) pp 571 – 597.
- 305.** Lyons R K 2002 Foreign exchange: Macro puzzles, micro tools *Economic Review* Federal Reserve Bank of San Francisco pp 51 – 69.
- 306.** Lyons R K 2003 Explaining and forecasting exchange rates with order flows *Economie Internationale* CEPII research center issue 96 pp 107 – 127.
- 307.** Fan M, Lyons R K, 2003, Customer trades and extreme events in foreign exchange in Central banking, monetary theory and practice: Essays in honor of Charles Goodhart Mizen P (editor) vol **2** pp 160 – 179 *Edward Elgar* Cheltenham UK.
- 308.** Killeen W P, Lyons R K, Moore M J (June) 2006 Fixed versus flexible: Lessons from EMS order flow *Journal of International Money and Finance Elsevier* **25** (4) pp 551 – 579.
- 309.** Lyons R K (January) 2006 The microstructure approach to exchange rates *MIT Press* edition 1 vol **1** ISBN 026262205x Cambridge MA USA.
- 310.** O'Hara M, Oldfield G 1986 The microeconomics of market making *Journal of Financial and Quantitative Analysis* **21** pp 361 - 376.
- 311.** Burdett K, O'Hara M 1987 Building blocks: An introduction to block trading *Journal of Banking and Finance* **13** pp 397 – 419.
- 312.** O'Hara M 1995, 1998 Market microstructure theory *Blackwell Business* Cambridge MA USA, *John Wiley and Sons Inc* USA.
- 313.** Shleifer A 1986 Do demand for stock slope down? *Journal of Finance* **41** (3) pp 579 – 590.
- 314.** Shleifer A, Summers L 1990 The noise trader approach to finance *Journal of Economic Perspectives* **4** (2) pp 19 – 33.
- 315.** Sweeney R 1986 Beating the foreign exchange market *The Journal of Finance* **41** pp 163 – 182.
- 316.** DeLong B, Shleifer A, Summers L, Waldmann R 1990 Positive feedback investment strategies, and destabilizing rational speculation *Journal of Finance* **45** pp 379 – 396.
- 317.** Bilson J F, Hsieh D 1987 The profitability of currency speculation *International Journal of Forecasting* **3** pp 115 – 130.
- 318.** Glassman D 1987 Exchange rate risk and transactions costs: Evidence from bid-ask spreads *Journal of International Money and Finance* **6** (4) pp 479 – 490.

- 319.** Gerlach S 1987 Exchange rates: A review essay *Journal of Monetary Economics* **19** pp 137 –142.
- 320.** Hasbrouck J, Ho T S H 1987 Order arrival, quote behaviour and the return - generating process *The Journal of Finance* **42** (4) pp 1035 – 1048.
- 321.** Hasbrouck J 1988 Trades, quotes, inventories, and information *Journal of Financial Economics* **22** pp 229 – 252.
- 322.** Hasbrouck J 1991 Measuring the information content of stock trades *Journal of Finance* **46** pp 179 – 207.
- 323.** Hasbrouck J, Sofianos G 1993 The trades of market makers: An empirical analysis of NYSE specialists *Journal of Finance* **48** pp 1565 – 1593.
- 324.** Hasbrouck J, Seppi D 2001 Common factors in prices, order flows, and liquidity *Journal of Financial Economics* **59** pp 383 – 411.
- 325.** Hodrick R 1987 The empirical evidence on the efficiency of forward and futures foreign exchange markets in *Fundamentals of pure and applied economics* vol **24** Harwood Academic Publishers New York USA.
- 326.** Ito T, Roley V 1987 News from the US and Japan: Which moves the Yen/Dollar exchange rate? *Journal of Monetary Economics* **19** pp 255 – 277.
- 327.** Ito T, Roley V V 1990 Intraday Yen/Dollar exchange rate movements: News or noise? *Journal of International Financial Markets, Institutions and Money* vol **1** no 1.
- 328.** Canova F, Ito T 1991 The time series properties of the risk premium in the Yen/Dollar exchange market *Journal of Applied Econometrics* **6** pp 125 – 142.
- 329.** Ito T, Engle R F, Lin W-L 1992 Where does the meteor shower come from? The role of stochastic policy coordination *Journal of International Economics* **32** pp 221 – 240.
- 330.** Ito T, Lin W 1992 Lunch break and intraday volatility of stock returns: An hourly data analysis of Tokyo and New York stock markets *Economics Letters* **39** pp 85 - 90.
- 331.** Ito T, Isard P, Symansky St, Bayoumi T 1996 Exchange rate movements and their impact on trade and investment in the APEC region *IMF Occasional Paper no 145* International Monetary Fund.
- 332.** Ito T, Lyons R K, Melvin M T 1998 Is there private information in the FX market? The Tokyo experiment *Journal of Finance American Finance Association* **53** (3) pp 1111 – 1130.
- 333.** Ito T (April) 2002 Is foreign exchange intervention effective? The Japanese experience in the 1990s *NBER Working Paper no 8914* NBER MA USA.
- 334.** Ito T 2005a The exchange rate in the Japanese economy: The past, puzzles, and prospects *Japanese Economic Review* **56** no 1 pp 1 – 38.

- 335.** Ito T 2005b The Yen and the Japanese economy: 2004 in Dollar adjustment: How far? Against what? Bergsten F, Williamson J (editors) *Institute of International Economics* Washington DC pp 171 – 196.
- 336.** Ito T, Hashimoto Y 2006 Intraday seasonality in activities of the foreign exchange markets: Evidence from the electronic broking system *Journal of Japanese and International Economics* **20** pp 637 – 664.
- 337.** Mendelson H 1987 Consolidation, fragmentation, and market performance *Journal of Financial and Quantitative Analysis* **22** pp 189 – 208.
- 338.** Newey W, West K 1987 A simple positive semi-definite, heteroskedasticity and autocorrelation consistent covariance matrix *Econometrica* **55** pp 703 – 708.
- 339.** Rubinstein A, Wolinsky A 1987 Middlemen *Quarterly Journal of Economics* **102** pp 581 – 593.
- 340.** Taylor M P 1987 Covered interest parity: A high-frequency, high-quality data study *Economica* **54** (216) pp 429 – 438.
- 341.** Taylor M P 1989 Covered interest arbitrage and market turbulence *Economic Journal* **99** pp 376 – 391.
- 342.** Allen H, Taylor M P 1989 Chartists, noise and fundamentals: A study of the London foreign exchange market *Working Paper no 341* Centre for Economic Policy Research London UK.
- 343.** Taylor M P, Allen H 1992 The use of technical analysis in the foreign exchange market *Journal of International Money and Finance* **11** (3) pp 304 – 314.
- 344.** Taylor M P 1995 The economics of exchange rates *Journal of Economic Literature* **33** pp 13 – 47.
- 345.** Sarno L, Taylor M P 2000 Official intervention in the foreign exchange market *University of Oxford* UK.
- 346.** Sarno L, Taylor M P 2001a Official intervention in the foreign exchange market: Is it effective and if so how does it work? *Journal of Economic Literature* **39** pp 839 – 868.
- 347.** Sarno L, Taylor M P 2001b The microstructure of the foreign exchange market. A selective survey of the literature *Princeton Studies in International Economics Series no 89* Princeton University Press Princeton NJ USA.
- 348.** Taylor M P 2005 Official foreign exchange intervention as a coordinating signal to the Dollar-Yen market *Pacific Economic Review* **10** pp 73 – 82.
- 349.** Sager M, Taylor M P 2005 Order flow and exchange rate movements *Typescript* University of Warwick UK.

- 350.** Reitz S, Taylor M P 2006 The coordination channel of foreign exchange intervention: A non-linear microstructural analysis *Deutsche Bundesbank Discussion Paper no 08/2006* Germany.
- 351.** Sager M, Taylor M P 2006 Under the microscope: The structure of the foreign exchange market *International Journal of Finance and Economics* **11** pp 81 – 95.
- 352.** Sager M J, Taylor M P 2008 Commercially available order flow data and exchange rate movements: Caveat emptor *Journal of Money, Credit and Banking* **40** (4) pp 583 – 625.
- 353.** Schulmeister St 1987 An essay on exchange rate dynamics *Research Unit Labor Market and Employment Discussion Paper no 87-8* Wissenschaftszentrum Berlin für Sozialforschung Berlin Germany.
- 354.** Melvin M, Taylor M P 2009 The crisis in the foreign exchange market *Journal of International Money and Finance* **28** (8) pp 1317 – 1330.
- 355.** Newey W, West K A 1987 Simple, positive semidefinite, heteroskedasticity and autocorrelation consistent covariance matrix *Econometrica* **55** pp 703 – 708.
- 356.** Wolff Ch C P 1987 Forward foreign exchange rates, expected spot rates, and premia: A signal-extraction approach *Journal of Finance* **42** (2) pp 395 – 406.
- 357.** Admati A, Pfleiderer P 1988 A theory of intraday patterns: Volume and price variability *The Review of Financial Studies* **1** pp 3 – 40.
- 358.** Admati A, Pfleiderer P 1989 Divide and conquer: A theory of intraday and day - of - the - week mean effects *The Review of Financial Studies* **2** (2) pp 189 – 223.
- 359.** Boothe P 1988 Exchange rate risk and the bid-ask spread *Economic Inquiry* **XXVI** pp 485 – 492.
- 360.** Choi J Y, Salandro D, Shastri K 1988 On the estimation of bid - ask spreads: Theory and evidence *Journal of Financial Analysis* **23** pp 219 – 230.
- 361.** Clinton K 1988 Transactions costs and covered interest arbitrage: Theory and evidence *Journal of Political Economy* **96** pp 358 - 370.
- 362.** Goodhart Ch A E 1988 The foreign exchange market: A random walk with a dragging anchor *Economica* **55** (220) pp 437 – 460.
- 363.** Goodhart Ch A E (October) 1989 “News” and the foreign exchange market *Proceedings of Manchester Statistical Society* Manchester UK pp 1 – 79.
- 364.** Goodhart Ch A E, Demos A (Winter) 1990 Reuters screen images of the foreign exchange market: The Deutschmark / Dollar spot rate *Journal of International Securities Markets* **4** pp 333 – 348.

- 365.** Goodhart Ch A E, Curcio R (January) 1991 The clustering of bid / ask prices and spreads in the foreign exchange market *Discussion Paper 110* Financial Markets Group London School of Economics and Political Science London UK.
- 366.** Goodhart Ch A E, Demos A 1991a Reuters screen images of the foreign exchange market: The Yen / Dollar and Sterling / Dollar spot market *Journal of International Securities Markets* **5** Spring pp 35 – 64.
- 367.** Goodhart Ch A E, Demos A (September 2nd) 1991b The Asian surprise in the forex markets *Financial Times* p 13.
- 368.** Goodhart Ch A E, Figliuoli L 1991 Every minute counts in financial markets *Journal of International Money and Finance* **10** (1) pp 23 – 52.
- 369.** Goodhart Ch A E 1992 News effects in a high-frequency model of the Sterling-Dollar exchange rate *Journal of Applied Econometrics* **7**.
- 370.** Goodhart Ch A E, Hall S, Henry S, Pesaran B 1993 News effects in a high frequency model of the Sterling-Dollar exchange rate *Journal of Applied Econometrics* **8** pp 1 – 13.
- 371.** Goodhart Ch A E, Hesse T 1993 Central bank forex intervention assessed in continuous time *Journal of International Money and Finance* **12** pp 368 – 389.
- 372.** Goodhart Ch A E, Ito T, Payne R 1995, 1996 One day in June, 1993: A study of the working of Reuters 2000-2 electronic foreign exchange trading system *National Bureau of Economic Research* Cambridge MA USA pp 1 – 133, in *The microstructure of foreign exchange markets* Frankel J, Galli G, Giovannini A (editors) *University of Chicago Press* Chicago IL USA pp 107 – 179.
- 373.** Goodhart Ch A E, O'Hara M 1995 High frequency data in financial markets: Issues and applications *Introductory Lecture Proceedings of the First International Conference on High Frequency Data in Finance (HFDF-1)* Research Institute for Applied Economics Olsen & Associates Zürich Switzerland.
- 374.** Goodhart Ch A E, Payne R G 1996 Microstructural dynamics in a foreign exchange electronic broking system *Journal of International Money and Finance* **15** (6) pp 829 – 852.
- 375.** Goodhart Ch A E, O'Hara M 1997 High frequency data in financial markets: Issues and applications' *Journal of Empirical Finance* **4** pp 73 – 114.
- 376.** Goodhart Ch A E, Love R, Payne R, Rime D 2002 Analysis of spreads in the Dollar/Euro and Deutschemark/Dollar foreign exchange markets *Economic Policy* **17** (35) pp 537 – 552.
- 377.** Hardouvelis G 1988 Economic news, exchange rates, and interest rates *Journal of International Money and Finance* **7** pp 23 – 25.

- 378.** Lewis K 1988 Testing the portfolio balance model: A multilateral approach *Journal of International Economics* **7** pp 273 – 288.
- 379.** Lewis K 1995 Puzzles in international financial markets in Handbook of international economics Grossman G, Rogoff K (editors) vol **3** *North Holland Publishing Company* Amsterdam The Netherlands.
- 380.** Baldwin R, Krugman P 1989 Persistent trade effects of large exchange rate shocks *The Quarterly Journal of Economics* **104** (4) pp 635 – 654.
- 381.** Baxter M, Stockman A 1989 Business cycles and the exchange rate regime: Some international evidence *Journal of Monetary Economics* **23** pp 377 – 400.
- 382.** Dooley M, Lizondo S, Mathieson D 1989 The currency composition of foreign exchange reserves *IMF Staff Papers* **36** no 2 pp 385 – 434.
- 383.** Giovannini A 1989 How do fixed exchange rate regimes work? Evidence from the gold standard, Bretton Woods and the EMS in Blueprints for exchange rate management Miller M, Eichengreen B, Portes R (editors) *Academic* New York USA.
- 384.** Golub S 1989 Foreign currency government debt, asset markets, and the balance of payments *Journal of International Money and Finance* **8** pp 285 – 294.
- 385.** Humpage O 1989 On the effectiveness of exchange market intervention *Federal Reserve Bank of Cleveland* USA.
- 386.** Leach C, Madhavan 1989 Price experimentation and market structure *Working Paper* Wharton School University of Pennsylvania USA.
- 387.** Leahy M 1989 The profitability of US intervention *Technical Report 343* Board of Governors Federal Reserve Bank Washington DC USA.
- 388.** Miller M, Eichengreen B, Portes R (editors) 1989 Blueprints for exchange rate management *Academic* New York USA.
- 389.** Van Hagen J 1989 Monetary targeting with exchange rate constraints: The Bundesbank in the 1980s *Federal Reserve Bank of St Louis* USA.
- 390.** Allen H L, Taylor M P 1990 Charts, noise and fundamentals in the London foreign exchange market *Economic Journal* **100** (Supplement) pp 49 – 59.
- 391.** Allen H L, Karjalainen R 1999 Using genetic algorithms to find technical trading rules *Journal of Financial Economics* **51** pp 245 – 271.
- 392.** Courakis A, Taylor M P (editors) 1990 Private behavior and government policy in interdependent economies *Clarendon* Oxford UK.
- 393.** Diebold F X, Nason J 1990 Nonparametric exchange rate prediction? *Journal of International Economics* **28** pp 315 – 332.

394. Flood R, Hodrick R 1990 On testing for speculative bubbles *Journal of Economic Perspectives* **4** pp 85 – 101.
395. Flood R, Rose A 1995 Fixing exchange rates: A virtual quest for fundamentals *Journal of Monetary Economics* **36** pp 3 – 37.
396. Flood R, Taylor M 1996 Exchange rate economics: What's wrong with the conventional macro approach? in *The microstructure of foreign exchange markets* Frankel J, Galli G, Giovannini A (editors) *The University of Chicago Press* Chicago USA pp 261 – 294.
397. Flood R, Marion N 2001 Holding international reserves in an era of high capital mobility in *Brookings Trade Forum 2001* Collins S, Rodrik D (editors) *Brookings Institution Press* Washington DC USA.
398. Foster D, Viswanathan S 1990 A theory of inter-day variations in volumes variances, and trading costs in securities markets *Review of Financial Studies* **3** pp 593 – 624.
399. Foster D, Viswanathan S 1993 Variations in trading volume, return volatility, and trading costs: Evidence on recent price formation models *Journal of Finance* **48** 187 – 211.
400. Holthausen R W, Leftwich R W, Mayers D 1990 Large-block transactions, the speed of response, and temporary and permanent stock-price effects *Journal of Financial Economics* **26** (1) pp 71 – 95.
401. De Long J B, Shleifer A, Summers L H, Waldmann R J 1990 Noise trader risk in financial markets *Journal of Political Economy* **98** (4) pp 703 – 738.
402. Domowitz I (June) 1990 The mechanics of automated trade execution systems *Journal of Financial Intermediation* **1** pp 167 – 194.
403. Domowitz I 1993 A taxonomy of automated trade execution systems *Journal of International Money and Finance* **12** (6) pp 607 – 631.
404. Domowitz I, Steil B (September) 1999 Automation, trading costs and the structure of the securities trading industry *Brookings-Wharton Papers on Financial Services* pp 33 – 92.
405. Johansen S, Juselius K 1990 Maximum likelihood estimation and inference on cointegration with applications to the demand for money *Oxford Bulletin of Economics and Statistics* **52** (2) pp 169 – 210.
406. Johansen S 1991 Estimation and hypothesis testing of cointegration vectors in Gaussian vector autoregressive models *Econometrica* **59** (6) pp 1551 – 1580.
407. Johansen S 1992 Cointegration in partial systems and the efficiency of single equation analysis *Journal of Econometrics* **52** pp 389 – 402.
408. Jorion P 1990 The exchange-rate exposure of United-States multinationals *Journal of Business* **63** pp 331 – 345.

409. Jorion P 1991 The pricing of exchange rate risk in the stock market *Journal of Financial and Quantitative Analysis* **26** (3) pp 363 – 376.
410. Jorion P 1996 Risk and turnover in the foreign exchange market in *The microstructure of foreign exchange markets* Frankel J A, Galli G, Giovannini A (editors) *University of Chicago Press* Chicago USA pp 19 – 37.
411. Lo A W, MacKinley A C 1990 An econometric analysis of nonsynchronous trading *Journal of Econometrics* **45** pp 181 – 211.
412. Melino A, Turnbull S M 1990 Pricing foreign currency options with stochastic volatility *Journal of Econometrics* **45** pp 239 – 265.
413. Melino A, Turnbull S M 1995 Misspecification and the pricing and hedging of long-term foreign currency options *Journal of International Money and Finance* **14** pp 373 – 393.
414. Mishkin F 1990 What does the term structure tell us about future inflation? *Journal of Monetary Economics* **25** (1) pp 77 – 95.
415. Müller U A, Dacorogna M M, Olsen R B, Pictet O, Schwarz M, Morgenegg C 1990 Statistical study of foreign exchange rates, empirical evidence of a price scaling law, and intraday analysis *Journal of Banking and Finance* **14** pp 1189 – 1208.
416. Müller U A, Dacorogna M M, Dave R D, Pictet O V, Olsen R B, Ward J R 1993 Fractals and intrinsic time - A challenge to econometricians *Technical Report UAM 1993-08-16 Research Institute for Applied Economics Olsen & Associates* Zurich Switzerland.
417. Müller U A, Dacorogna M M, Dave R D, Olsen R B, Pictet O V, von Weizsäcker J E 1995 Volatilities of different time resolutions - Analyzing the dynamics of market components *Preprint UAM 1995-01-12 Research institute for Applied economics Olsen & Associates* Zurich Switzerland.
418. Roell A 1990 Dual capacity trading and the quality of the market *Journal of Financial Intermediation* **1** pp 105 – 124.
419. Seppi D 1990 Equilibrium block trading and asymmetric information *Journal of Finance* **45** pp 73 – 94.
420. Bali T 1991 An empirical comparison of continuous time models of the short term interest rate *Journal of Futures Markets* **19** (7) pp 777 – 797.
421. Bhattacharya U, Spiegel M 1991 Insiders, outsiders, and market breakdowns *Review of Financial Studies* **4** pp 255 – 282.
422. Black S 1991 Transaction costs and vehicle currencies *Journal of International Money and Finance* **10** pp 512 - 527.

423. Bossaerts P, Hillion P 1991 Market microstructure effects of government intervention in the foreign exchange market *Review of Financial Studies* **4** pp 513 – 541.
424. Burnham J B 1991 Current structure and recent developments in foreign exchange markets in *Recent developments in international banking and finance* Khonry S J (editor) *Elsevier Science Publishing North Holland Publishing Company* pp 123 – 163.
425. Campbell J, LaMaster S, Smith V, Van Boening M 1991 Off-floor trading, disintegration, and the bid-ask spread in experimental markets *Journal of Business* **64** pp 495 – 522.
426. Campbell J, Lo A, MacKinlay A 1997 *The econometrics of financial markets* Princeton University Press USA.
427. Chinn M D 1991 Some linear and non-linear thoughts on exchange rates *Journal of International Money and Finance* **10** pp 214 – 230.
428. Chinn M D, Meese R A 1995 Banking on currency forecasts: How predictable is change in money *Journal of International Economics* **38** pp 161 – 178.
429. Chowdhry B, Nanda V 1991 Multimarket trading and market liquidity *Review of Financial Studies* **4** pp 483 – 511.
430. Edwards S 1991 Real exchange rates, devaluation, and adjustment – Exchange rate policy in developing countries *MIT Press* USA.
431. Froot K A, Obstfeld M 1991 Exchange rate dynamics under stochastic regime shifts: A unified approach *Journal of International Economics* **31** pp 203 – 229.
432. Froot K A, Rogoff K 1995 Perspectives on PPP and long-run real exchange rates in *Handbook of international economics* Grossman G, Rogoff K (editors) *Elsevier Science Amsterdam* pp 1647 – 1688.
433. Froot K A, Ramadorai T (August) 2002 Currency returns, institutional investor flows, and exchange rate fundamentals *NBER Working Paper 9101* NBER USA.
434. Froot K A, Donohue 2004 Decomposing the persistence of international equity flows *Finance Research Letters* pp 154 – 170.
435. Froot K A, Ramadorai T 2005 Currency returns, intrinsic value, and institutional-investor flows *Journal of Finance* **60** pp 1535 – 1566.
436. Georg Th, Kaul G, Nimalendran M 1991 Estimation of the bid-ask spread and its components: A new approach *Review of Financial Studies* **4** pp 623 – 656.
437. Grabbe J O 1991 *International financial markets* 2nd edition *Elsevier Science Publishing Co Inc* New York USA.
438. Harvey C R, Huang R D Volatility in the foreign currency futures market *Review of Financial Studies* **4** pp 543 – 569.

- 439.** Khonry S J (editor) 1991 Recent developments in international banking and finance *Elsevier Science Publishing North Holland Publishing Company* The Netherlands.
- 440.** Kim O, Verrecchia R 1991 Trading volume and price reactions to public announcements *Journal of Accounting Research* **29** pp 302 – 321.
- 441.** Kim O, Verrecchia R 1994 Market liquidity and volume around earnings announcements *Journal of Accounting and Economics* **17** pp 41 – 67.
- 442.** Kim O, Verrecchia R 1997 Pre-announcement and event-period information *Journal of Accounting and Economics* **24** pp 395 – 419.
- 443.** Klein M 1991 Managing the dollar: Has the Plaza agreement mattered? *Journal of Money, Credit, and Banking* **23** pp 742 – 751.
- 444.** Klein M, Rosengren E 1991 Foreign exchange intervention as a signal of monetary policy *New England Economic Review* pp 39 – 50.
- 445.** Lease R, Masulis R, Page J 1991 An investigation of market microstructure impacts on event study returns *The Journal of Finance* **46** pp 1523 – 1536.
- 446.** LeBaron B 1991 Technical trading rules and regime shifts in foreign exchange *Technical Report* University of Wisconsin - Madison WI USA.
- 447.** Lee Ch M C, Ready M J 1991 Inferring trade direction from intraday data *Journal of Finance* **46** pp 733 – 746.
- 448.** Messe R A, Rose A K 1991 An empirical assessment of nonlinearities in models of exchange rate determination *Review of Economic Studies* **58** 603-2-19.
- 449.** Subrahmanyam A 1991 Risk aversion, market liquidity, and price efficiency *Review of Financial Studies* **4** pp 417 – 442.
- 450.** Spiegel M, Subrahmanyam A 1992 Informed speculation and hedging in a non-competitive securities market *Review of Financial Studies* **5** (2).
- 451.** Spiegel M, Subrahmanyam A 1995 On intraday risk premia *Journal of Finance* **50** pp 319 - 339.
- 452.** Williamson J (May) 1991 Advice on the choice of an exchange rate policy *Working Paper no 3* ICEG.
- 453.** Bekaert G, Hodrick R J 1992 Characterizing predictable components in excess returns on equity and foreign exchange markets *The Journal of Finance* **47** pp 467 – 511.
- 454.** Choi J J, Elyasiani E, Kopecky K J 1992 The sensitivity of bank stock returns to market, interest and exchange rate risk *Journal of Banking and Finance* **16** (5) pp 983 – 1005.
- 455.** Choi J J, Elyasiani E 1997 Derivatives exposure and the interest rate and exchange rate risks of US banks *Journal of Financial Services Research* **12** (2/3) pp 267 – 286.

- 456.** Curcio R, Goodhart Ch 1992 When support / resistance levels are broken, can profits be made? Evidence from the foreign exchange market *Discussion Paper no 142* Financial Markets Group London School of Economics London UK.
- 457.** Curcio R, Goodhart Ch, Guillaume D, Payne R 1997 Do technical trading rules generate profits? Conclusions from the intra-day foreign exchange market *International Journal of Finance and Economics* **2** (4) pp 267 – 280.
- 458.** De Grauwe P, Decupere D 1992 Psychological barriers in the foreign exchange market *Journal of International and Comparative Economics* **1** (2) pp 87 – 101.
- 459.** De Grauwe P, Grimaldi M 2006a The exchange rate in a behavioural framework *Princeton University Press* Princeton USA.
- 460.** De Grauwe P, Grimaldi G 2006b Exchange rate puzzles: A tale of switching attractors *European Economic Review* **50** pp 1 – 33.
- 461.** Edison H J 1992, 1993 The effectiveness of central bank intervention: A survey of the post - 1982 literature *Working Paper* Federal Reserve Board of Governors Washington DC USA, *Princeton Studies in International Economics* **18** Princeton University Princeton NJ USA.
- 462.** Edison H J, Liang H 1999 Foreign exchange intervention and the Australian dollar: Has it mattered? *IMF Working Paper WP/03/99*.
- 463.** Edison H J (September) 2003 Are foreign exchange reserves in Asia too high? in World economics outlook (September 2003) *International Monetary Fund* Washington DC USA.
- 464.** Flood M D 1994 Market structure and inefficiency in the foreign exchange market *Journal of International Money and Finance* **13** (2) pp 131 – 158.
- 465.** Flood M D, Rose A K 1995 Fixing exchange rates: A virtual quest for fundamentals *Journal of Monetary Economics* **36** pp 3 – 37.
- 466.** Flood M D, Huisman R, Koedijk K, Mahieu R (December) 1996 Price discovery in multiple-dealer financial markets: The effect of pre-trade transparency *Typescript* Concordia University.
- 467.** Flood M D, Huisman R, Koedijk K, Mahieu R 1998 Quote disclosure and price discovery in multiple dealer financial markets *Review of Financial Studies*.
- 468.** Gosh A 1992 Is it signaling? Exchange intervention and the Dollar Deutsche-mark rate *Journal Of International Economics* **32**.
- 469.** Guillaume D M, Dacorogna M M, Dave R R, Müller U A, Olsen R B, Hamon O V, Jacquillat B 1992 Le marche Francais des actions *Presses Universitaires de France* Paris France.

- 470.** Guillaume D M, Pictet O V, Dacorogna M M 1995 On the intra-day performance of GARCH processes *Proceedings of the First International Conference on High Frequency Data in Finance (HFDF-1)* vol **3** Research Institute for Applied Economics Olsen & Associates Zürich Switzerland.
- 471.** Guillaume D M, Dacorogna M M, Dave R R, Müller U A, Olsen R B, Pictet O V 1997 From the bird's eye to the microscope: A survey of new stylized facts of the intra - daily foreign exchange markets *Finance and Stochastics* **1** (2) pp 95 – 129.
- 472.** Hansen B 1992 Tests for parameter instability in regressions with I (1) processes *Journal of Business and Economic Statistics* **10** pp 321 – 335.
- 473.** Holden C, Subrahmanyam A 1992 Long-lived private information and imperfect competition *Journal of Finance* **47** pp 247 – 270.
- 474.** Neal R 1992 A comparison of transaction costs between competitive market maker and specialist market structures *Journal of Business* **65** pp 317 – 334.
- 475.** Pesaran M H, Samiei H 1992 Estimating limited - dependent rational expectations models with an application to exchange rate determination in a target zone *Journal of Econometrics* **53** pp 141 – 163.
- 476.** Rhee S G, Chang R P 1992 Intra-day arbitrage opportunities in foreign exchange and Euro-currency markets *Journal of Finance* **47** pp 363 – 379.
- 477.** Svensson L E O 1992 An interpretation of recent research on exchange rate target zones *Journal of Economic Perspectives* **6** (1) pp 19 – 44.
- 478.** Svensson L E O 1993 Assessing target zone credibility *European Economic Review* **37** pp 763 – 802.
- 479.** Bertola G, Svensson L E O 1993 Stochastic devaluation risk and the empirical fit of target zone models *Review of Economic Studies* **60** pp 689 – 712.
- 480.** Rose A K, Svensson L E O 1994 European exchange rate credibility before the fall *European Economics Review* **38** pp 1185 – 1216.
- 481.** Taylor S J 1992 Rewards available to currency futures speculators: Compensation for risk or evidence of inefficient pricing? *Economic Record* **68** pp 105 – 116.
- 482.** Zhou B 1992a High frequency data and volatility in foreign exchange rates *Manuscript* Department of Finance Sloan School of Management MIT Cambridge MA USA.
- 483.** Zhou B 1992b Forecasting foreign exchange rates subject to de-volatilization *Working Paper no 3510* Sloan School of Management Massachusetts Institute of Technology Cambridge MA USA.

- 484.** Zhou B 1997 Currency exchange in a random search model *Review of Economic Studies* **64** pp 289 – 310.
- 485.** Bank for International Settlements 1993 Survey of foreign exchange market activity *Monetary and Economic Department Bank for International Settlements* Basel Switzerland www.bis.org .
- 486.** Bank for International Settlements (May) 1999 Central bank survey of foreign exchange market activity in April 1998 *Monetary and Economics Department Bank for International Settlements* Basel Switzerland www.bis.org .
- 487.** Bank for International Settlements (October) 1999 A review of financial market events in autumn 1998 *Committee on the Global Financial System Bank for International Settlements* Basel Switzerland www.bis.org .
- 488.** Bank for International Settlements (June) 2001 70th annual report *Bank for International Settlements* Basel Switzerland www.bis.org .
- 489.** Bank for International Settlements 2002 Central bank survey of foreign exchange market activity in April 2001 *Monetary and Economics Department Bank for International Settlements* Basel Switzerland www.bis.org .
- 490.** Bank for International Settlements 2004 Triennial central bank survey: Foreign exchange and derivatives market activity in 2004 *Monetary and Economics Department Bank for International Settlements* Basel Switzerland www.bis.org .
- 491.** Bank for International Settlements (March) 2005 Triennial central bank survey of foreign exchange and derivatives market activity in 2004 *Bank for International Settlements* Basel Switzerland ISSN 1814-7356 www.bis.org .
- 492.** Bank for International Settlements (May) 2005 Foreign exchange market intervention in emerging markets: motives, techniques and implications *BIS Paper no 24* ISSN 1609-0381 pp 1 – 307 Monetary and Economic Department *Bank for International Settlements* Basel Switzerland www.bis.org .
- 493.** Bank for International Settlements (December) 2007 Triennial central bank survey of foreign exchange and derivatives market activity in 2007 *Bank for International Settlements* Basel Switzerland ISSN 1814-7356 <http://www.bis.org/publ/rpfx07t.pdf?noframes=1> .
- 494.** Bank for International Settlements 2010 Triennial central bank survey. Foreign exchange and derivatives market activity in 2010 *Bank for International Settlements* Basel Switzerland ISSN 1814-7356 www.bis.org .
- 495.** Bertola G, Svensson L E O 1993 Stochastic devaluation risk and the empirical fit of target zone models *Review of Economic Studies* **60** pp 689 – 712.

- 496.** Biais B 1993 Price formation and equilibrium liquidity in fragmented and centralized markets *Journal of Finance* **48** pp 157 – 184.
- 497.** Chan Y-S, Weinstein M 1993 Reputation, bid-ask spread and market structure *Financial Analysts Journal* July/August pp 57 – 62.
- 498.** Cheung Y - W 1993 Exchange rate risk premiums *Journal of International Money and Finance* **12** pp 182 – 194.
- 499.** Cheung Y-W, Ng L 1996 A causality-in-variance test and its application to financial market prices *Journal of Econometrics* **72** pp 33 – 48.
- 500.** Cheung Y - W, Chinn M 1998 Integration, cointegration, and the forecast consistency of structural exchange rate models *Journal of International Money and Finance* **17** pp 813 – 830.
- 501.** Cheung Y-W, Wong C Y-P 1999 Foreign exchange traders in Hong Kong, Tokyo, and Singapore in *Advances in pacific basin financial markets* vol **5** Bos Th, Fetherstone Th A (editors) *JAI Press* Greenwich Connecticut pp 111 – 134.
- 502.** Cheung Y - W, Wong C 2000 A survey of market practitioners' views on exchange rate dynamics *Journal of International Economics* **51** pp 401 – 423.
- 503.** Cheung Y - W, Chinn M D 2001 Currency traders and exchange rate dynamics: A survey of the US market *Journal of International Money and Finance* **20** (4) pp 439 – 471.
- 504.** Cheung Y-W, Chinn M D, Marsh I W 2004 How do UK-based foreign exchange dealers think their market operates? *International Journal of Finance and Economics* **9** pp 289 – 306.
- 505.** Cheung Y - W, Chinn M, Pascual A G 2004, 2005 Empirical exchange rate models of the nineties: Are any fit to survive? *IMF Working Paper WP/04/73* IMF Washington USA, *Journal of International Money and Finance* **24** pp 1150 – 1175.
- 506.** Dacorogna M M, Müller U A, Nagrel R J, Olsen R B, Pictet O V 1993 A geographical model for the daily and weekly seasonal volatility in the FX market *Journal of International Money and Finance* **12** (4) pp 413 – 438.
- 507.** Dacorogna M M, Müller U A, Pictet O V, de Vries C G (March 17) 1995 The distribution of external foreign exchange rate returns in extremely large data sets *Preprint UAM 1992-10-22* Research Institute for Applied Economics *Olsen and Associates* Zurich Switzerland.
- 508.** Dominguez K M E, Frankel J A 1993 Does foreign exchange intervention work? Institute for International Economics Washington DC USA.
- 509.** Dominguez K M E 1998 Central bank intervention and exchange rate volatility *Journal of International Money and Finance* **17** pp 161 – 190.

- 510.** Dominguez K M E 2006 When do central bank interventions influence intra-daily and longer-term exchange rate movements? *Journal of International Money and Finance* **25** (7) pp 1051 – 1071.
- 511.** Dominguez K M E, Panthaki F 2006 What defines ‘news’ in foreign exchange markets? *Journal of International Money and Finance* **25** (1) pp 168 – 198.
- 512.** Ederington L, Lee J 1993 How markets process information: News releases and volatility *Journal of Finance* **48** pp 1161 – 1191.
- 513.** Edin P A, Vredin A 1993 Devaluation risk in target zones: Evidence from the Nordic countries *Economic Journal* **103** pp 161 – 175.
- 514.** Goldstein M, Folkerts-Landau D, Garber P, Rojas-Suarez L, Spencer M 1993 International capital markets Parts I and II *The International Monetary Fund* Washington DC USA.
- 515.** Griffiths M D, White R W (June) 1993 Tax - induced trading and the turn - of - the - year anomaly: An intraday study *The Journal of Finance* **48** (2) pp 575 – 598.
- 516.** Grimes A 1993 International reserves under floating exchange rates: Two paradoxes explained *The Economic Record* **69** pp 411 – 415.
- 517.** Harris M, Raviv A 1993 Differences of opinion make a horse race *Review of Financial Studies* **6** pp 473 – 506.
- 518.** Klein M W 1993 The accuracy of reports of foreign exchange intervention *The Journal of International Money and Finance* **12** (6) pp 644 – 653.
- 519.** Levich R M, Thomas L R 1993 The significance of technical trading-rule profits in the foreign exchange market: A bootstrap approach *Journal of International Money and Finance* **12** pp 451 – 474.
- 520.** Matsuyama K, Kiyotaki N, Matsui A 1993 Toward a theory of international currency *Review of Economic Studies* **60** pp 283 – 320.
- 521.** Romer D 1993 Rational asset-price movements without news *American Economic Review* **83** pp 1112 – 1130.
- 522.** Schmidt H, Iversen P, Treske K 1993 Parkett oder computer? *Zeitschrift für Bankrecht und Bankwirtschaft* **5** pp 209 – 221.
- 523.** Schmidt H, Iversen P 1993 Automating German equity trading: Bid-ask spreads on competing systems *Journal of Financial Services Research* **6** pp 373 – 397.
- 524.** Schmidt H, Oesterhelweg O, Treske K 1996 Deutsche Börsen im Leistungsvergleich: IBIS und BOSS-CUBE *Kredit und Kapital* **29** pp 90 – 122.

- 525.** Wolinsky A 1990 Information revelation in a market with pair wise meetings
Econometrica **58** pp 1 – 23.
- 526.** Ammer J, Brunner A 1994 Are banks market timers or market makers? Explaining foreign exchange trading profits *International Finance Discussion Paper #484* Board of Governors of the Federal Reserve System USA.
- 527.** Andrew R, Broadbent J 1994 Reserve bank operations in the foreign exchange market: Effectiveness and profitability *Research Discussion Paper 9406* Reserve Bank of Australia Sydney Australia.
- 528.** Backus D, Kehoe P, Kydland F 1994 Dynamics of the trade balance and the terms of trade: The J-curve? *American Economic Review* **84** pp 84 – 103.
- 529.** Bakker A, Boot H, Sleijpen O, Vanthoor W (editors) 1994 Monetary stability through international cooperation *Kluwer Academic Publishers* Dordrecht The Netherlands.
- 530.** Bartov E, Bodnar G M 1994 Firm valuation, earnings expectations, and the exchange rate exposure effect *Journal of Finance* **44** (5) pp 1755 – 1785.
- 531.** Bartov E, Bodnar G M 1995 Foreign currency translation reporting and the exchange-rate exposure effect *Journal of International Financial Management & Accounting* **6** (2) pp 93 – 115.
- 532.** Berry T, Howe K 1994 Public information arrival *Journal of Finance* **49** pp 1331 – 1346.
- 533.** Bessembinder H (June) 1994 Bid - ask spreads in the inter-bank foreign exchange markets *Journal of Financial Economics* **35** (3) pp 317 – 348.
- 534.** Ball C, Roma A 1994 Target zone modelling and estimation for European monetary system exchange rates *Journal of Empirical Finance* **1** pp 385 – 420.
- 535.** Brousseau V, Czarnecki M O (August 16) 1994 Modelling exchange rates: The stable model *Preprint* Ecole Polytechnique Paris France.
- 536.** De Jong F 1994 A univariate analysis of EMS exchange rates using a target zone model *Journal of Applied Econometrics* **9** pp 35 – 45.
- 537.** De Jong F, Nijman Th, Röell A 1995 A comparison of the cost of trading French shares on the Paris bourse and on SEAQ *International European Economic Review* **39** pp 1277 – 1301.
- 538.** De Jong F, Nijman Th, Röell A 1996 Price effects of trading and components of the bid-ask spread on the Paris bourse *Journal of Empirical Finance* **3** pp 193 – 213.
- 539.** De Jong F, Mahieu R, Schotman P 1998 Price discovery in the foreign exchange market: An empirical analysis of the Yen / Dmark rate *Journal of International Money and Finance* **17** pp 5 – 27.

540. De Jong F, Ligterink J, Macrae V 2006 A firm specific analysis of the exchange rate exposure of Dutch firms *Journal of International Financial Management and Accounting* **17** (1) pp 1 – 28.
541. De Jong F, Verschoor W F C, Zwinkels R C J 2010 Heterogeneity of agents and exchange rate dynamics: Evidence from the EMS *Journal of International Money and Finance* **29** (8) pp 1652 – 1669.
542. Degryse H, de Jong F, van Kervel V 2011 The impact of dark trading and visible fragmentation on market quality *Discussion Paper 8630 CEPR*.
543. Dini L 1994 Turbulence in the foreign exchange markets: Old and new lessons in Monetary stability through international cooperation Bakker A, Boot H, Sleijpen O, Vanthoor W (editors) *Kluwer Academic Publishers Dordrecht The Netherlands*.
544. Fialkowski D, Petersen 1994 Posted versus effective spreads: Good prices or bad quotes? *Journal of Financial Economics* **35** pp 269 – 292.
545. Glass G R 1994 Multinet *Panel Discussion: Clearing house arrangements in the foreign exchange markets Federal Reserve Board's International Symposium: Banking and payment services Washington DC USA*.
546. Grünbichler A, Longstaff F, Schwartz E 1994 Electronic screen trading and the transmission of information: An empirical examination *Journal of Financial Intermediation* **3** pp 166 – 187.
547. Hansch O, Naik N, Viswanathan S (November) 1994 Trading profits, inventory control and market share in a competitive dealer market *Typescript Duke University USA*.
548. Hirschleifer D, Subrahmanyam A, Titman S 1994 Security analysis and trading patterns when some investors receive information before others *Journal of Finance* **49** pp 1665 – 1698.
549. Hogan K C Jr, Melvin M 1994 Sources of meteor showers and heat waves in the foreign exchange market *Journal of International Economics* **37** pp 239 – 247.
550. Jones C, Kaul G, Lipson M 1994 Transactions, volume, and volatility *Review of Financial Studies* **7** pp 631 – 651.
551. Jones C, Lipson M 1999 Execution costs of institutional equity orders *Journal of Financial Intermediation* **8** pp 123 – 140.
552. Kraus A, Smith M (September) 1994 Beliefs about beliefs *Working Paper University of British Columbia Vancouver Canada*.
553. Massib M, Phelps B 1994 Electronic trading, market structure and liquidity *Financial Analysts Journal* pp 39 – 50.

- 554.** Mendelson M, Peake J (September) 1994 Equity markets in economies in transition *Journal of Banking and Finance* **15** (5) pp 913 – 929.
- 555.** Naidu G N, Rozeff M 1994 Volume, volatility, liquidity and efficiency of the Singapore stock exchange before and after automation *Pacific-Basin Finance Journal* **2** pp 23 – 42.
- 556.** Nieuwland F G M C, Verschoor W F C, Wolff C C P 1994 Stochastic jumps in EMS exchange rates *Journal of International Money and Finance* **13** pp 699 – 727.
- 557.** Pictet O V, Dacorogna M M, Muller U A, De Vries C G 1994 The distribution of external foreign exchange rate returns and extremely large data sets *Olsen and Associates Research Group* Zurich Switzerland.
- 558.** Sharpe W A (Fall) 1994 The Sharpe ratio *Journal of Portfolio Management* pp 49 – 58.
- 559.** Silber W L 1994 Technical trading: When it works and when it doesn't *The Journal of Derivatives* **1** (3).
- 560.** Slezak S 1994 A theory of the dynamics of security returns around market closures *Journal of Finance* **49** pp 1163 – 1211.
- 561.** Szpiro G G 1994 Exchange rate speculation and chaos inducing intervention *Journal of Economic Behavior and Organization* **24** pp 363 – 368.
- 562.** Yadav P, Pope P, Paudyal K 1994 Threshold autoregressive modeling in finance: The rice differences of equivalent assets *Mathematical Finance* **4** (2) pp 205 – 221.
- 563.** Walsh E J 1994 Operating income, exchange rate changes, and the value of the firm: An empirical analysis *Journal of Accounting, Auditing and Finance* **9** (4) pp 703 – 724.
- 564.** Wei, Sh-J (May) 1994 Anticipations of foreign exchange volatility and bid-ask spreads *Working Paper no 4737* National Bureau of Economic Research Cambridge Massachusetts USA.
- 565.** Watanabe T 1992 The signaling effect of foreign exchange intervention: The case of Japan *Bank of Japan* Tokyo Japan.
- 566.** Watanabe T, Harada K 2004 Effects of the Bank of Japan's intervention on yen/dollar exchange rate volatility *Journal of the Japanese and International Economies*.
- 567.** Watanabe T, Yabu T (June) 2007 The great intervention and massive money injection: The Japanese experience 2003-2004 *Working Paper* Institute of Economic Research Hitotsubashi University Japan.
- 568.** Almekinders G J 1995 Foreign exchange intervention: Theory and evidence *E Elgar* Brookfield VT USA.
- 569.** Chiang T, Jiang C 1995 Foreign exchange returns over short and long horizons *International Review of Economics & Finance* **4** pp 267 – 282.

- 570.** Dumas B, Solnik B 1995 The world price of foreign exchange risk *Journal of Finance* **50** pp 445 – 479.
- 571.** Ederington L, Lee J 1995 The short-run dynamics of price adjustment to new information *Journal of Financial and Quantitative Analysis* **30** pp 117 – 134.
- 572.** Evertsz C J G 1995 Self - similarity of high - frequency USD/DEM exchange rates *Proceedings of the First International Conference on High Frequency Data in Finance (HFDF-1)* vol **3** Research Institute for Applied Economics Olsen & Associates Zürich Switzerland.
- 573.** Faruquee H 1995 Long-run determinants of the real exchange rate: A stock-flow perspective *IMF Staff Papers* **42** (1) pp 80 – 107.
- 574.** Frino A, McCorry M 1995 Why are spreads tighter on the Australian Stock Exchange than the NYSE? An electronic open limit order book versus the specialist structure *Working Paper* University of Sydney Australia.
- 575.** Frino A, McInish Th, Toner M 1998 The liquidity of automated exchanges: New evidence from German bund futures *Journal of International Financial Markets, Institutions and Money* **8** pp 225 – 241.
- 576.** Ghysels E, Jasiak J 1995 Trading patterns: Time deformation and stochastic volatility in foreign exchange markets *Proceedings of the First International Conference on High Frequency Data in Finance (HFDF-1)* vol **1** Research Institute for Applied Economics Olsen & Associates Zürich Switzerland.
- 577.** Grossman G, Rogoff K (editors) 1995 Handbook of international economics *Elsevier Science* The Netherlands.
- 578.** Havrilesky T 1995 The pressures on American monetary policy 2nd edition *Kluwer Academic Publishing* Boston USA.
- 579.** Hong H, Wang J (July) 1995 Trading and returns under periodic market closures *Working Paper* Massachusetts Institute of Technology USA.
- 580.** Isard P 1995 Exchange rate economics *Cambridge University Press* Cambridge UK.
- 581.** Kandel E, Pearson N 1995 Differential interpretation of public signals and trade in speculative markets *Journal of Political Economy* **103** pp 831 – 872.
- 582.** Lewis K K 1995 Are foreign exchange intervention and monetary policy related and does it really matter? *Journal of Business* **68** pp 185 – 214.
- 583.** Lin J-C, Sanger G, Booth G 1995 Trade size and components of the bid-ask spread *Review of Financial Studies* **8** pp 1153 – 1183.

- 584.** Mantegna R N, Stanley H E 1995 Scaling behaviour in economic index *Nature* vol **376** pp 46 – 49.
- 585.** Mark N 1995 Exchange rates and fundamentals: Evidence on long-horizon predictability *American Economic Review* **85** pp 201 – 218.
- 586.** Mark N, Wu Y 1998 Rethinking deviations from uncovered interest parity: The role of covariance risk and noise *Economic Journal* **108** pp 1686 – 1706.
- 587.** Mark N 2001 International macroeconomics and finance *Blackwell Publishers* Oxford UK.
- 588.** Mark N 2009 Changing monetary policy rules, learning, and real exchange rate dynamics *Journal of Money, Credit and Banking*.
- 589.** Obstfeld M, Rogoff K 1995 Exchange rate dynamics redux *Journal of Political Economy* **103** pp 624-660.
- 590.** Obstfeld M, Rogoff K (August) 1998 Risk and exchange rates *NBER Working Paper 6694* in Contemporary economic policy: Essays in honor of Assaf Razin; Helpman E, Sadka E (editors) *Cambridge University Press* Cambridge UK.
- 591.** Osler C L 1995 Exchange rate dynamics and speculator horizon *Journal of International Money and Finance* **14** (5) pp 695 – 720.
- 592.** Osler C L 1998 Short-term speculators and the puzzling behavior of exchange rates *Journal of International Economics* **45** pp 37 – 57.
- 593.** Carlson J A, Osler C L (March) 1999 Determinants of currency risk premiums *Federal Reserve Bank of New York Staff Reports Series* no 70.
- 594.** Kevin C P H, Osler C L 1999 Methodical madness: Technical analysis and the irrationality of exchange-rate forecasts *Economic Journal* **109** (458) pp 636 – 661.
- 595.** Osler C L 2000 Support for resistance: Technical analysis and intraday exchange rates *Federal Reserve Bank of New York Economic Policy Review* **6** (2) pp 53 – 68.
- 596.** Osler C L 2003 Currency orders and exchange-rate dynamics: Explaining the success of technical analysis *Journal of Finance* **58** (5) pp 1791 – 1819.
- 597.** Osler C L 2005 Stop-loss orders and price cascades in currency markets *Journal of International Money and Finance* **24** (2) pp 219 – 241.
- 598.** Carlson A J, Osler C L 2005 Short-run exchange rate dynamics: Theory and evidence.
- 599.** Osler C L 2006 Macro lessons from microstructure *International Journal of Finance and Economics* **11** (1) pp 55 – 80.
- 600.** Osler C L 2008 Foreign exchange microstructure: A survey in Springer encyclopedia of complexity and system science *Springer* Germany.

- 601.** Osler C L 2009 Market microstructure, foreign exchange *in* Encyclopedia of complexity and system science Meyers R A (ed.) *Springer* pp 5404 – 5438.
- 602.** Osler C L, Vandrovysh V 2009 Hedge funds and the origins of private information in currency markets *Typescript* Brandeis University.
- 603.** Osler C L, Yusim R 2009 Intraday dynamics of foreign-exchange spreads *Typescript* Brandeis University.
- 604.** Osler C L, Mende A, Menkhoff L 2011 Price discovery in currency markets *Journal of International Money and Finance* **30** (8) pp 1696 – 1718.
- 605.** Osler C L, Savaser T 2011 Extreme returns: The case of currencies *Journal of Banking and Finance* **35** (11) pp 2868 – 2880.
- 606.** Dahl Ch, Carlson J A, Osler C L 2011 Short-run exchange-rate dynamics: Theory and evidence *Research Paper* Brandeis University.
- 607.** Osler C L 2012 Currency market microstructure, the carry trade, and technical trading *Annual Review of Financial Economics* **4** (1).
- 608.** Peiers B (October) 1995 Informed traders, intervention, and price leadership: A deeper view of the microstructure of the foreign exchange market *University California Los Angeles* California USA.
- 609.** Prasad A M, Rajan M 1995 The role of exchange and interest risk in equity valuation: A comparative study of international stock markets *Journal of Economics and Business* **47** (5) pp 457 – 472.
- 610.** Schnidrig R, Würtz D (March) 1995 Investigation of the volatility and autocorrelation function of the USD/DEM exchange rate on operational time scales *Proceedings of the First International Conference on High Frequency Data in Finance* (HFDF-1) vol **3** *Research Institute for Applied Economics Olsen & Associates* Zürich Switzerland.
- 611.** Schwartz R (editor) 1995 Global equity markets: Technological, competitive, and regulatory challenges *Irwin* Homewood Illinois USA.
- 612.** Shyy G, Lee J 1995 Price transmission and information asymmetry in bund futures markets: LIFFE vs DTB *Journal of Futures Markets* **15** pp 87 – 99.
- 613.** Shyy G, Vijayraghavan V, Scott-Quinn B 1996 A further investigation of the lead-lag relationship between the cash market and stock index futures market with the use of bid/ask quotes: The case of France *Journal of Futures Markets* **16** pp 405 – 420.
- 614.** Vivex X 1995 The speed of information revelation in a financial market mechanism *Journal of Economic Theory* **67** pp 178 – 204.

- 615.** Zaheer A, Zaheer S (December) 1995 Catching the wave: Alertness, responsiveness, and market influence in global electronic networks *Typescript* University of Minnesota USA.
- 616.** Bonser – Neal C, Tanner G 1996 Central bank intervention and volatility of foreign exchange rates: Evidence from options market *Journal of International Money and Finance* vol **15** pp 853 – 878.
- 617.** Claassen E M 1996 Global monetary economics *Oxford University Press* Oxford UK.
- 618.** Danker D, Haas R A, Henderson D W, Symanski S, Tryon R W 1996 Small empirical models of exchange market intervention: Applications to Germany, Japan, and Canada *Journal of Policy Modeling* **9**.
- 619.** Dukas S P, Fatemi A M, Tavakkol A 1996 Foreign exchange rate exposure and the pricing of exchange rate risk *Global Finance Journal* **7** (2) pp 169 – 189.
- 620.** Dwyer G, Locke P, Yu W 1996 Index arbitrage and nonlinear dynamics between the S&P 500 futures and cash *Review of Financial Studies* **9** (1) pp 301 – 332.
- 621.** Easley D, Kiefer N, O’Hara M, Paperman J 1996 Liquidity, information and infrequently traded stocks *Journal of Finance* **51** pp 1405 – 1436.
- 622.** Easley D, Kiefer N, O’Hara M 1997a The information content of the trading process *Journal of Empirical Finance* **4** pp 159 – 185.
- 623.** Easley D, Kiefer N, O’Hara M 1997b One day in the life of a very common stock *Review of Financial Studies*.
- 624.** Easley D, O’Hara M, Srinivas P S 1998 Option volume and stock prices: Evidence on where informed traders trade *Journal of Finance* **53** pp 431 – 465.
- 625.** Flemming J, Ostdiek B, Whaley R 1996 Trading costs and the relative rates of price discovery in stocks, futures and options markets *Journal of Futures Markets* **16** pp 353 – 387.
- 626.** Gagnon J E 1996 Net foreign assets and equilibrium exchange rates: Panel evidence *Board of Governors of the Federal Reserve System International Finance Discussion Papers* 574 USA.
- 627.** Ghashghaie S, Breyman W, Peinke J, Talkner P, Dodge Y (June) 1996 Turbulent cascades in foreign exchange markets *Nature* **381** (27) pp 767 – 770.
- 628.** Hsieh D, Kleidon A 1996 Bid-ask spreads in foreign exchange markets: Implications for models of asymmetric information *in* The Microstructure of foreign exchange markets Frankel J A, Galli G, Giovannini A (editors) *University of Chicago Press* Chicago pp 41 – 65.

629. Ingersoll J E Jr 1996 Valuing foreign exchange rate derivatives with a bounded exchange process *Review of Derivatives Research* **1** pp 159 – 181.
630. Kaminsky G, Lewis K 1996 Does foreign exchange intervention signal future monetary policy? *Journal Of Monetary Economics* **37** pp 285 – 312.
631. LeBaron B (March) 1996 Technical trading rule, profitability and foreign exchange intervention *Working Paper 5505* NBER USA pp 1 – 18.
632. MacDonald R, Marsh I W 1996 Currency forecasters are heterogeneous: Confirmation and consequences *Journal of International Money and Finance* **15** (5) pp 665 – 685.
633. Madrigal V 1996 Non-fundamental speculation *Journal of Finance* **51** pp 553 – 578.
634. Pirrong C 1996 Market liquidity and depth on computerized and open outcry trading systems: A comparison of DTB and LIFFE bund contracts *Journal of Futures Markets* **16** pp 519 – 543.
635. Rosenberg M 1996 Currency forecasting: A guide to fundamental and technical models of exchange rate determination *Irwin Professional Publishing* Chicago USA.
636. Tsang Sh-K 1996 A study of the linked exchange rate system and policy options for Hong Kong *Hong Kong Policy Research Institute* Hong Kong P R China.
637. Tsang Sh-K 1998 The case for adopting the convertible reserves system in Hong Kong *Pacific Economic Review* **3** pp 265 – 275.
638. Tsang Sh-K, Sin Ch-Y, Cheng Y-Sh 1999 The robustness of Hong Kong's linked exchange rate system as a currency board arrangement *The 54th European Meeting of the Econometric Society* Hong Kong P R China.
639. Tsang Sh-K 1999a A study of the linked exchange rate system and policy options for Hong Kong *Hong Kong Policy Research Institute Ltd* Hong Kong P R China.
640. Tsang Sh-K 1999b Fixing the exchange rate through a currency board arrangement: Efficiency risk, systemic risk and exit cost *Asian Economic Journal* **13** pp 239 – 266.
641. Tsang Sh-K, Yue Ma 2002 Currency substitution and speculative attacks on a currency board system *Journal of International Money and Finance* **21** (1) pp 53 – 78.
642. Vermeiren D, Ková T Z 1996 Foreign exchange risk management and auditing *Basic Documentation Version 1.0a* Prague CNB – Banking Supervision 1996.
643. Balke N, Fomby T 1997 Threshold cointegration *International Economic Review* **38** pp 627 – 646.
644. Balke N, Wohar M 1998 Nonlinear dynamics and covered interest rate parity *Empirical Economics* **23** pp 535 – 559.

- 645.** Bhattacharya U, Weller P 1997 The advantage to hiding one's hand: Speculation and central bank intervention in the foreign exchange market *Journal of Monetary Economics* **39** pp 251 – 277.
- 646.** Campbell J Y, Lo A W, MacKinlay A C 1997 The econometrics of financial markets *Princeton University Press* Princeton New Jersey USA.
- 647.** Campbell J Y, Viceira L 2002 Strategic asset allocation: Portfolio choice for long term investors *Clarendon Lectures in Economics Oxford University Press* Oxford UK.
- 648.** Chamberlain S, Howe J S, Popper H 1997 The exchange rate exposure of US and Japanese banking institution *Journal of Banking and Finance* **21** (6) pp 871 – 892.
- 649.** Clarida R H, Taylor M P 1997 The term structure of forward exchange premiums and the forecastability of spot exchange rates: Correcting the errors *Review of Economics and Statistics* **79** pp 353 – 361.
- 650.** Clarida R H, Sarno L, Taylor M P, Valente G 2003 The out-of-sample success of term structure models as exchange rate predictors: A step beyond *Journal of International Economics* **60** pp 61 – 83.
- 651.** Copejans M, Domowitz I 1997 The performance of an automated trading market in an illiquid environment *Working Paper* Duke University, Northwestern University USA.
- 652.** DeGennaro R, Shrieves R 1997 Public information releases, private information arrival, and volatility in the foreign exchange market *Journal of Empirical Finance* **4** pp 295 – 315.
- 653.** Dewachter H 1997 Sign predictions of exchange rate changes: Charts as proxies for Bayesian inferences *Review of World Economics* **133** (1) pp 39 – 55.
- 654.** Dewachter H 2001 Can Markov switching models replicate chartist profits in the foreign exchange market? *Journal of International Money and Finance* **20** pp 25 – 41.
- 655.** Dewachter H, Lyrio M 2005 The economic value of technical trading rules: A nonparametric utility-based approach *International Journal of Finance and Economics* **10** pp 41 – 62.
- 656.** Embrechts P, Klueppelberg C, Mikosch T 1997 Modeling external events for insurance and finance *Springer - Verlag* Berlin Germany.
- 657.** Evans M D D (November) 1997 The microstructure of foreign exchange dynamics *Typescript* Georgetown University USA.
- 658.** Evans M D D, Lyons R K 1999, (February) 2002a Order flow and exchange rate dynamics *Typescript* UC Berkeley, *Journal of Political Economy* **110** (1) pp 170 – 180.
- 659.** Evans M D D, Lyons R K 2001a Why order flow explains exchange rates *Unpublished Manuscript* University California Berkeley USA.

- 660.** Evans M D D, Lyons R K (July) 2001b Portfolio balance, price impact, and secret intervention *NBER Working Paper 8356* NBER USA.
- 661.** Evans M D D (February) 2001c, 2002b FX trading and exchange rate dynamics *NBER Working Paper 8116*; *Journal of Finance* **57** (6) pp 2405 – 2447.
- 662.** Evans M D D, Lyons R K (July) 2002c Time-varying liquidity in foreign exchange *Journal of Monetary Economics Elsevier* **49** (5) pp 1025 – 1051.
- 663.** Evans M D D, Lyons R K (November) 2002d Informational integration and FX Trading *Journal of International Money and Finance* **21** (6) pp 807 – 831.
- 664.** Evans M D D, Lyons R K (January) 2003 How is macro news transmitted to exchange rates? *NBER Working Paper 9433* National Bureau of Economic Research Inc USA.
- 665.** Cao H, Evans M, Lyons R (August) 2003 Inventory information *NBER Working Paper 9893* NBER USA <http://www.nber.org/papers/w9893>, *Journal of Business*, USA.
- 666.** Evans M D D, Lyons R K (March) 2004a A new micro model of exchange rate dynamics *NBER Working Papers 10379* National Bureau of Economic Research Inc USA <http://www.nber.org/papers/w10379> .
- 667.** Evans M D D, Lyons R K 2004b, 2007 Exchange rate fundamentals and order flow *Working Papers gueconwpa~05-05-03* Department of Economics Georgetown University; *Working Paper 13151* National Bureau of Economic Research Cambridge MA USA <http://www.nber.org/papers/w13151> .
- 668.** Evans M D D, Lyons R K 2005a Meese-Rogoff redux: Micro-based exchange-rate forecasting *NBER Working Paper 11042* National Bureau of Economic Research <http://www.nber.org/papers/w11042>, *American Economic Review Papers and Proceedings* **95** (2) pp 405 – 414.
- 669.** Evans M D D, Lyons R K 2005b Do currency markets absorb news quickly? *Working Paper 11041* NBE USA pp 1 – 25, *Journal of International Money and Finance* **24** (2) pp 197 – 217.
- 670.** Evans M D D, Lyons R 2005c Are different-currency assets imperfect substitutes? in Exchange rate economics: Where do we stand? DeGrauwe P (editor) *MIT Press* Cambridge USA.
- 671.** Evans M D D, Lyon R K 2005d, 2006 Understanding order flow *NBER Working Paper 11748* NBER USA <http://www.nber.org/papers/w11748>, *International Journal of Finance & Economics John Wiley & Sons Inc* **11** (1) pp 3 – 23.
- 672.** Evans M D D 2005 Where are we know? Real-time estimates of the macroeconomy *International Journal of Central Banking* **1** (6) pp 127 – 175.

673. Evans M D D, Hnatkovska V 2005 International capital flows, returns and world financial integration *NBER Working Paper* NBER USA.
674. Evans M D D, Lyons R K 2008 How is macro news transmitted to exchange rates? *Journal of Financial Economics* **88** (1) pp 26 – 50.
675. Evans M D D, Lyons R K 2009 Forecasting exchange rate fundamentals with order flow *Working Paper* Georgetown University USA.
676. Evans M D D 2010 Order flows and the exchange rate disconnect puzzle *Journal of International Economics* **80** (1) pp 58 – 71.
677. Evans M D D 2011 Exchange-rate dynamics *Princeton University Press* USA.
678. Fleming M, Remolona E 1997 What moves the bond market? *Federal Reserve Bank of New York Economic Policy Review* **3** pp 31 – 50.
679. Fleming M, Remolona E 1999 Price formation and liquidity in the US treasury market *Journal of Finance* **54** pp 1901 – 1915.
680. Fleming M (September) 2002 Price discovery in the US treasury market: The impact of order flow and liquidity on the yield curve *Typescript* New York Federal Reserve Bank New York USA.
681. Fleming M 2003 Measuring treasury market liquidity *Federal Reserve Bank of New York Economic Policy Review* **9** pp 83 – 108.
682. Franke G, Hess D 1997, 2000 Information diffusion in electronic and floor trading *Working Paper* Universität Konstanz Germany, *Journal of Empirical Finance* **7** (5) pp 455 – 478.
683. Goldberg L, Tenorio R 1997 Strategic trading in a two-sided foreign exchange auction *Journal of International Economics* **42** pp 299 – 326.
684. Gosh A R, Ostry J D, Gulde A M, Wolf H C 1997 Does the exchange rate regime matter for inflation and growth? *IMF* Washington USA <http://www.imf.org> .
685. Harris J, Schultz P 1997 The importance of firm quotes and rapid executions: Evidence from the January 1994 SOES rule change *Journal of Financial Economics* **45** pp 135 – 166.
686. Hartmann P 1997 The currency denomination of international trade after European Monetary Union *Typescript* European Central Bank.
687. Hartmann Ph 1998 Do Reuters spreads reflect currencies' differences in global trading activity? *Journal of International Money and Finance* **17** (5) pp 757 – 784.
688. Hartmann P 1998 Currency competition and foreign exchange markets: The dollar, the yen, and the euro *Cambridge University Press* Cambridge UK.

- 689.** Hartmann P 1999 Trading volumes and transaction costs in the foreign exchange market: Evidence from daily dollar-yen spot data *Journal of Banking and Finance* **23** pp 801 – 824.
- 690.** Hung J 1997 Intervention strategies and exchange rate volatility: A noise trading perspective *Journal of International Money and Finance* **16** (5) pp 779 – 793.
- 691.** Kirilenko A 1997 Endogenous trading arrangements in emerging foreign exchange markets *Typescript* International Monetary Fund USA.
- 692.** Lamoureux C, Schnitzlein C 1997 When it's not the only game in town: The effect of bilateral search on the quality of a dealer market *Journal of Finance* **52** pp 683 – 712.
- 693.** Madhavan A, Smidt S 1991 A Bayesian model of intraday specialist pricing *Journal of Financial Economics* **30** pp 99 – 134.
- 694.** Madhavan A, Smidt S 1993 An analysis of changes in specialist inventories and quotations *Journal of Finance* **48** (5) pp 1595 – 1628.
- 695.** Leach J, Madhavan A 1993 Price experimentation and security market structure *Review of Financial Studies* **6** pp 375 – 404.
- 696.** Keim D, Madhavan A 1996 The upstairs market for large-block transactions: Analysis and measurement of price effects *Review of Financial Studies* **9** pp 1 – 36.
- 697.** Madhavan A, Cheng M 1997 In search of liquidity: Block trades in the upstairs and downstairs market *Review of Financial Studies* **10** pp 175 – 203.
- 698.** Madhavan A, Richardson M, Roomans M 1997 Why do security prices change? A transaction-level analysis of NYSE stocks *Review of Financial Studies* **10** pp 1035 – 1064.
- 699.** Madhavan A, Sofianos G 1997 An empirical analysis of NYSE specialist trading *Journal of Financial Economics* **48** pp 189 – 210.
- 700.** Madhavan A (March) 2000 Market microstructure: A survey *University of Southern California* USA.
- 701.** Madhavan A 2000 Market microstructure: A survey *Journal of Financial Markets* **3** pp 205 – 258.
- 702.** Madhavan A (October) 2000 In search of liquidity in the internet era *9th Annual Financial Markets Conference of the Federal Reserve Bank of Atlanta* USA.
- 703.** Martens M 1997 Interaction between financial markets *Tinbergen Institute Research Series no 139* Rotterdam The Netherlands.
- 704.** Montiel P J 1997 Exchange rate policy and macroeconomic management tin ASEAN countries in macroeconomic issues facing ASEAN countries *International Monetary Fund* Washington USA.

- 705.** Pagano M, Roell A 1997 Front running: Market professionals as quasi-insiders *Typescript* Tilburg University.
- 706.** Peiers B 1997 Informed traders, intervention, and price leadership: A deeper view of the microstructure of the foreign exchange market *Journal of Finance* **52** pp 1589 – 1614.
- 707.** Reiss P, Werner I (February) 1997 Interdealer trading: Evidence from London *Stanford Graduate School of Business Research Paper no 1430* University of Stanford California USA.
- 708.** Sweeney R J 1997 Do central banks lose on foreign exchange intervention? A review article *Journal of Banking & Finance* **21** pp 1667 – 1684.
- 709.** Sweeney R J 2000 Does the Fed beat the foreign exchange market? *Journal of Banking & Finance* **24** pp 665 – 694.
- 710.** Szakmary A, Mathur I 1997 Central bank intervention and trading rule profits in foreign exchange markets *Journal of International Money and Finance* **16** pp 513 – 535.
- 711.** Vogler K 1997 Risk allocation and interdealer trading *European Economic Review* **41** pp 417 – 441.
- 712.** Wei S, Kim J (November) 1997 The big players in the foreign exchange market: Do they trade on information or noise? *NBER Working Paper 6256* NBER USA.
- 713.** Werner I (September) 1997 A double auction model of interdealer trading *Research Paper no 1454* Stanford University California USA.
- 714.** Wren-Lewis S (July) 1997 The choice of exchange rate regime *Economic Journal*.
- 715.** Abhyankar A H 1998 Linear and nonlinear Granger causality: Evidence from the UK stock index futures market *Journal of Futures Markets* **18** (5) pp 519 – 540.
- 716.** Abrams R K, Beato P 1998 The prudential regulation and management of foreign exchange risk *International Monetary Fund* Washington DC USA.
- 717.** Anthony M, MacDonald R 1998 On the mean reverting properties of target zone exchange rates: Some evidence from the ERM *European Economic Review* **42** pp 1493 – 1523.
- 718.** Anthony M, MacDonald R 1999 The width of the band and exchange rate mean reversion: Some further ERM-Based Results *Journal of International Money and Finance* **18** pp 411 – 428.
- 719.** Bjønnes G H, Rime D (December) 1998 FX trading ... live: Impact of new trading environments *Typescript* Norwegian School of Management University of Oslo Norway.

720. Bjønnes G H, Rime D (March) 2001 FX trading live! Dealer behavior and trading systems in foreign exchange markets *Typescript* Norwegian School of Management University of Oslo Norway www.uio.no/~dagfinri .
721. Bjønnes G H, Rime D 2005 Dealer behavior and trading systems in foreign exchange markets *Journal of Financial Economics* **75** (3) pp 571 – 605.
722. Bjønnes G H, Rime D, Solheim H O A 2005 Liquidity provision in the overnight foreign exchange market *Journal of International Money and Finance* **24** (2) pp 177 – 198.
723. Bjønnes G H, Osler C, Rime D (September 15) 2007 Asymmetric information in the interbank foreign exchange market *3rd Annual Conference on Market Microstructure* Budapest Hungary.
724. Bjønnes G H, Osler C L, Rime D 2011 Sources of information advantage in the foreign exchange market *Working Paper* Norges Bank Norway.
725. Blennerhasset M, Bowman R G 1998 A change in market microstructure: The switch to electronic screen trading on the New Zealand stock exchange *Journal of International Financial Markets, Institutions and Money* **8** pp 261 – 276.
726. Bodnar G, Hayt G, Marston R 1998 Wharton survey of financial risk management by US non-financial firms *Financial Management* **27** (4) pp 70 – 91.
727. Caramazza F, Aziz J 1998 Fixed or flexible? Getting the exchange rate right in the 1990s *IMF* Washington USA <http://www.imf.org> .
728. Chang Y, Taylor S 1998 Intraday effects of foreign exchange intervention by the Bank of Japan *Journal of International Money and Finance* **18** pp 191 – 210.
729. Choi J J, Hiraki T, Takezawa N 1998 Is foreign exchange risk priced in the Japanese stock market *Journal of Financial and Quantitative Analysis* **33** pp 361 – 382.
730. Chow E H, Chen H L 1998 The determinants of foreign exchange rate exposure: Evidence on Japanese firms *Pacific-Basin Finance Journal* **6** (1/2) pp 153 – 174.
731. Clark P B, Macdonald R 1998 Exchange rates and economic fundamentals: A methodological comparison of BEERS and FEERS *IMF Working Paper WP/98/67* IMF USA.
732. Covrig V, Melvin M 1998, 2002 Asymmetric information and price discovery in the FX market: Does Tokyo know more about the yen? *Typescript* Arizona State University, *Journal of Empirical Finance* **9** pp 271 – 285.
733. Eddelbuttel D, McCurdy T 1998 The impact of news on foreign exchange rates: Evidence from high frequency data *Typescript* University of Toronto Canada.

734. Edison H (February) 1998 On foreign exchange intervention: An assessment of the US experience *Typescript* Board of Governors of the Federal Reserve System USA.
735. Fleming J, Kirby C, Ostdiek B 1998 Information and volatility linkages in the stock, bond, and money markets *Journal of Financial Economics* **49** pp 111 – 137.
736. Garfinkel J, Nimalendran M 1998 Market structure and trader anonymity: An analysis of insider trading *Working Paper* Loyola University of Chicago University of Florida USA.
737. George E 1998 Exchange rates: An intractable aspect of monetary policy *Bank of England Quarterly Bulletin* (May 1998) **38** no 2.
738. Hansch O, Naik N, Viswanathan S 1998 Do inventories matter in dealership markets? Evidence from the London stock exchange *Journal of Finance* **53** pp 1623 – 1656.
739. Hau H 1998 Competitive entry and endogenous risk in the foreign exchange market *Review of Financial Studies* **11** pp 757 – 788.
740. Hau H, Killeen W, Moore M (July) 2000, 2002a The Euro as an international currency: Explaining puzzling first evidence from the foreign exchange markets *CEPR Discussion Paper no 2510* CEPR, *Journal of International Money and Finance* **21** (3) pp 351 – 383.
741. Hau H, Killeen W, Moore M (April) 2002b Euro's forex role: How has the Euro changed the foreign exchange market? *Economic Policy* pp 151 – 191.
742. Hau H, Rey H (December) 2002 Exchange rates, equity prices, and capital flows *NBER Working Paper 9398* NBER USA.
743. Hau H, Rey H 2003 Can portfolio rebalancing explain the dynamics of equity returns, equity flows, and exchange rates? *American Economic Review*.
744. He J, Ng L K 1998 The foreign exchange exposure of Japanese multinational corporations *Journal of Finance* **53** (2) pp 733 – 753.
745. Helpman E, Sadka E (editors) 1998 Contemporary economic policy: Essays in honor of Assaf Razin *Cambridge University Press* Cambridge U.K.
746. Hong Kong Monetary Authority 1998 Strengthening of currency board arrangements in Hong Kong *Quarterly Bulletin* November pp 1 – 5.
747. Isard P, Faruqee H 1998 Exchange rate assessment: Extensions of the macroeconomic balance approach *IMF Occasional Paper no 167* IMF Washington USA.
748. Isard P, Faruqee H, Kincaid G R, Fetherston M 2001 Methodology for current account and exchange rate assessments *IMF Occasional Paper no 209* International Monetary Fund Washington USA.
749. Kanas A 1998 Testing for a unit root in ERM exchange rates in the presence of structural breaks: Evidence from the boot-strap *Applied Economics Letters* **5** pp 407 – 410.

- 750.** Lee R 1998 What is an exchange? The automation, management and regulation of financial markets *Oxford University Press* Oxford UK.
- 751.** Litterman R, Winkelmann K (January) 1998 Estimating covariance matrices *Goldman Sachs Risk Management Series*.
- 752.** Lui Y - H, Mole D 1998 The use of fundamental and technical analyses by foreign exchange dealers: Hong Kong evidence *Journal of International Money and Finance* **17** pp 535 – 545.
- 753.** Menkhoff L 1998 The noise trading approach — Questionnaire evidence from foreign exchange *Journal of International Money and Finance* **17** pp 547 – 564.
- 754.** Gehrig Th, Menkhoff L 2000, 2004 The use of flow analysis in foreign exchange: Exploratory evidence *Typescript* Department of Economics University of Freiburg Germany, *Journal of International Money and Finance* **23** (4) pp 573 – 594.
- 755.** Mende A, Menkhoff L (March) 2003 Different counterparties, different foreign exchange trading? The perspective of a median bank.
- 756.** Mende A, Menkhoff L 2006 Profits and speculation in intra-day foreign exchange trading *Journal of Financial Markets* **9** (3) pp 223 – 245.
- 757.** Menkhoff L, Taylor M P 2007 The obstinate passion of foreign exchange professionals: Technical analysis, *Warwick Economic Research Papers no 769* Department Of Economics The University of Warwick UK pp 1 – 61, *Journal of Economic Literature* **45** (4) pp 936 – 972.
- 758.** Frömmel M, Mende A, Menkhoff L 2008 Order flows, news, and exchange rate volatility *Journal of International Money and Finance* **27** (6) pp 994 – 1012.
- 759.** Menkhoff L, Schmeling M 2008 Local information in foreign exchange markets *Journal of International Money and Finance* **27** (8) pp 1383 – 1406.
- 760.** Menkhoff L, Osler C L, Schmeling M (May 11) 2010 Limit-order submission strategies under asymmetric information *CESIFO Working Paper no 3054* Category 7: Monetary Policy and International Finance Department of Economics Leibniz University Hannover Germany pp 1 – 42.
- 761.** Menkhoff L 2010 High-frequency analysis of foreign exchange interventions: What do we learn? *Journal of Economic Surveys* **24** (1) pp 85 – 112.
- 762.** Menkhoff L, Schmeling M 2010 Trader see, trader do: How do (small) FX traders react to large counterparties' trades? *Journal of International Money and Finance*.
- 763.** Miller K D, Reuer J J 1998 Asymmetric corporate exposures to foreign exchange rate changes *Strategic Management Journal* **19** (12) pp 1183 – 1191.

- 764.** Miville M, DiMillo J 1998 Survey of the Canadian foreign exchange and derivatives markets *Bank of Canada Review Winter 1995-1996 Financial Markets Department Bank of Canada Ottawa Canada*.
- 765.** Nagayasu J 1998 Japanese effective exchange rates and determinants: Prices, real interest rates, and actual and optimal current accounts *IMF Working Paper WP/98/86 IMF USA*.
- 766.** Neely Ch 1998 Technical analysis and the profitability of US foreign exchange intervention *Federal Reserve Bank of St Louis Review* **80** pp 3 – 17.
- 767.** Neely Ch J 2000a The practice of central bank intervention: Looking under the hood *Central Banking* **XI** pp 24 – 37.
- 768.** Neely Ch J 2000b Are changes in foreign exchange reserves well correlated with official intervention? *Economic Review of the Federal Reserve Bank of St Louis September/October* pp 17 – 30.
- 769.** Neely C J 2004 Forecasting foreign exchange volatility: Why is implied volatility biased and inefficient? And does it matter? *Working Paper 2002-017D Federal Reserve Bank of St Louis MO USA*.
- 770.** Neely Ch J 2005 An analysis of recent studies of the effect of foreign exchange intervention *Federal Reserve Bank of St Louis Review November/December* **87** (6) pp 685 – 717.
- 771.** Pesaran M, Hasem P M, Smith R P 1998 Structural analysis of co-integrating VARs *Journal of Economic Survey* **12** (5) pp 471 – 505.
- 772.** Portes R, Rey H 1998 The emergence of the Euro as an international currency *Economic Policy* **26** pp 307 – 332.
- 773.** Rey H 2001 International trade and currency exchange *Review of Economic Studies* **68** pp 443 – 464.
- 774.** Reiss P, Werner I 1998 Does risk sharing motivate interdealer trading? *Journal of Finance* **53** pp 1657 – 1704.
- 775.** Sarkar A, Tozzi M (January) 1998 Electronic trading on futures exchanges *Current Issues in Economics and Finance Federal Reserve Bank of New York* **4** (1).
- 776.** Viswanathan S, Wang J 1998 Why is interdealer trade so pervasive in financial markets? *Working Paper Duke University North Carolina USA*.
- 777.** Viswanathan S, Wang J D 2000 Inter-dealer trading in financial markets *Working Paper Duke University Durham North Carolina USA*.

- 778.** Vitale P 1998 Two months in the life of several gilt-edged market makers on the London Stock Exchange *Journal of International Financial Markets, Institutions, & Money* **8** pp 301 – 326.
- 779.** Vitale P 1999 Sterilized central bank intervention in the foreign exchange market *Journal of International Economics* **49** pp 245 – 267.
- 780.** Vitale P 2000 Speculative noise trading and manipulation in the foreign exchange market *Journal of International Money and Finance* **19** pp 689 – 712.
- 781.** Vitale P 2003 Foreign exchange intervention: How to signal policy objectives and stabilize the economy *Journal of Monetary Economics* **50** pp 841 – 870.
- 782.** Vitale P 2004 A guided tour of the market microstructure approach to exchange rate determination *CEPR Working Paper 4530*.
- 783.** Vitale P 2006 A market microstructure analysis of foreign exchange intervention *Working Paper series no 629 / MAY 2006* European Central Bank Frankfurt am Main Germany ISSN 1561-0810 (print) ISSN 1725-2806 (online) pp 1 - 59 http://ssrn.com/abstract_id=902528 <http://www.ecb.int> .
- 784.** Yao J 1998 Market making in the interbank foreign exchange market *Salomon Center Working Paper #S-98-4* New York University NY USA.
- 785.** Alberola E, Cervero S G, Lopez H, Ubide A 1999 Global equilibrium exchange rates: Euro, Dollar, “ins”, “outs”, and other major currencies in a panel cointegration framework *IMF Working Paper WP/99/175* IMF USA.
- 786.** Bos Th, Fetherstone Th A (editors) 1999 *Advances in pacific basin financial markets* JAI Press Greenwich Connecticut USA.
- 787.** Carrera J 1999 Speculative attacks to currency target zones: A market microstructure approach *Journal of Empirical Finance* **6** pp 555 – 582.
- 788.** Chaboud A P, LeBaron B (July)1999 Foreign exchange market trading volume and Federal Reserve intervention *Typescript Brandeis University, Journal of Banking and Finance*.
- 789.** Chaboud A P, LeBaron B 2001 Foreign exchange market trading volume and Federal Reserve intervention *Journal of Futures Markets* **21** pp 851 – 860.
- 790.** Chaboud A P, Humpage O (January) 2005 An assessment of the impact of Japanese foreign exchange intervention: 1991-2004 *International Finance Discussion Paper 824* Board of Governors of the Federal Reserve System USA.

- 791.** Chaboud A P, Chernenko S, Wright J 2008 Trading activity and macroeconomic announcements in high-frequency exchange rate data *Journal of the European Economic Association* **6** pp 589 – 596.
- 792.** Chaboud A P, Chiquoine B, Hjalmarsson E, Vega C 2009 Rise of the machines: Algorithmic trading in the foreign exchange market *International Finance Discussion Papers* 980 Federal Reserve Board of Governors USA.
- 793.** Chaboud A P, Chiquoine B, Hjalmarsson E, Loretan M 2009 Frequency of observation and the estimation of integrated volatility in deep and liquid financial markets *Federal Reserve Board of Governors USA*.
- 794.** Fiess N, MacDonald R 1999 Technical analysis in the foreign exchange market: A cointegration-based approach *Multinational Finance Journal* **3** (3) pp 147 – 172.
- 795.** Fiess N, MacDonald R 2002 Towards the fundamentals of technical analysis: Analyzing the information content of high, low and close prices *Economic Modelling* **19** (3) pp 353 – 374.
- 796.** Fleming M, Lopez J 1999 Heat waves, meteor showers, and trading volume: An analysis of volatility spillovers in the US Treasury market *Federal Reserve Bank of New York Staff Reports* #82 NY USA.
- 797.** Freihube Th, Kehr C-H, J. Krahenen J, Theissen E 1999 Was leisten die kursmakler? Eine empirische untersuchung am beispiel der Frankfurter wertpapierbörse *Kredit und Kapital* **32** pp 426 – 460.
- 798.** Grammig J, Schiereck D, Theissen E 1999 Informationsbasierter aktienhandel über *IBIS Working Paper* Johann Wolfgang Goethe-Universität Frankfurt *Zeitschrift für betriebswirtschaftliche Forschung* Germany.
- 799.** Isard P, Razin A, Rose A (editors) 1999 *IMF and Kluwer* The Netherlands.
- 800.** Jeanne O, Rose A (April) 1999 Noise trading and exchange rate regimes *NBER Working Paper* #7104 NBER USA, *Quarterly Journal of Economics*.
- 801.** Kandel E, Marx L 1999 Payments for order flow on Nasdaq *Journal of Finance* **54** pp 35 – 66.
- 802.** LeBaron B 1999 Technical trading rule profitability and foreign exchange intervention *Journal of International Economics* **49** pp 125 – 214.
- 803.** Marks J 1999 The impact of the internet on users and suppliers of financial services *Brookings-Wharton Papers on Financial Services* pp 147 – 185.
- 804.** Macey J, O'Hara M 1999 Globalization, exchange governance and the future of exchanges *Brookings-Wharton Papers on Financial Services* pp 1 – 32.

- 805.** Naik N Y, Neuberger A, Viswanathan S 1999 Trade disclosure regulation in markets with negotiated trades *Review of Financial Studies* **12** (4) pp 873 – 900.
- 806.** Naik N Y, Yadav P 1999 The effects of market reform on trading costs of public investors: Evidence from the London stock exchange *Working Paper* London Business School and University of Strathclyde UK.
- 807.** Payne R (January) 1999, 2003 Informed trade in spot foreign exchange markets: An empirical investigation *Typescript* London School of Economics and Political Science London UK, *Journal of International Economics* **61** (2) pp 307 – 329.
- 808.** Payne R, Vitale P 2003, A transaction level study of the effects of central bank intervention on exchange rates *Journal of International Economics* **61** pp 331 – 352.
- 809.** Moore M J, Payne R 2011 On the sources of private information in FX markets *Journal of Banking and Finance* **35** (5) pp 1250 – 1262.
- 810.** Love R, Payne R 2004, 2008 Macroeconomic news, order flows, and exchange rates *Typescript* London School of Economics and Political Science London UK, *Journal of Financial and Quantitative Analysis* **43** pp 467 – 488.
- 811.** Rigobon R (September) 1999 On the measurement of the international propagation of shocks *NBER Working Paper 7354* NBER USA.
- 812.** Saar G (July) 1999 Demand uncertainty and the information content of order flow *Typescript Johnson School* Cornell University NY USA.
- 813.** Scalia A, Vacca V (October) 1999 Does market transparency matter? A case study *Banca d'Italia Discussion Paper 359* Bank of Italy Rome Italy.
- 814.** Scalia A (August) 2004 Is foreign exchange intervention effective? Some micro-analytical evidence from Central Europe *Typescript* Bank of Italy Rome Italy.
- 815.** Scalia A 2008 Is foreign exchange intervention effective? Some micro-analytical evidence from the Czech Republic *Journal of International Money and Finance* **27** (4) pp 529 – 546.
- 816.** Shapiro C, Varian H 1999 Information rules *Harvard Business School Press* Harvard University USA.
- 817.** Theissen E 1999 Floor versus screen trading: Evidence from the German stock market *Département Finance et Economie Groupe HEC* France, *Johann Wolfgang Goethe-Universität* Frankfurt/Main Frankfurt Germany pp 1 – 37.
- 818.** Vayanos D 1999 Strategic trading and welfare in a dynamic market *Review of Economic Studies* **66** pp 219 – 234.

- 819.** Vayanos D 2001 Strategic trading in a dynamic noisy market *Journal of Finance* **56** pp 131 – 171.
- 820.** Wang J 1999 Asymmetric information and the bid-ask spread: An empirical comparison between automated order execution and open outcry auction *Journal of International Financial Markets, Institutions and Money* **9** pp 115 – 128.
- 821.** Aliber R Z, Chowdhry Bh, Yan Sh 2000 Transactions costs in the foreign exchange market *University Of Chicago, The Anderson Graduate School of Management UCLA, University of Arizona USA* <http://www.escholarship.org/uc/item/4qw3p6rp> .
- 822.** Ausloos M 2000 Statistical physics in foreign exchange currency and stock markets *Physica A* **285** pp 48 – 65.
- 823.** Baillie R, Humpage O, Osterberg W 2000 Intervention from an information perspective *Journal of International Financial Markets, Institutions and Money* **10** pp 407 – 421.
- 824.** Carlson J, Osler C 2000 Rational speculators and exchange rate volatility *European Economic Review* **44** pp 231 – 253.
- 825.** Carlson J (August) 2002 One minute in the life of the DM/\$: Public information in an electronic market *Typescript Purdue University USA*.
- 826.** Ebrahim S K 2000 Volatility transmission between foreign exchange and money markets *Working Paper 2000-16 Bank of Canada Ottawa Canada*.
- 827.** Eichengreen B, Mathieson D J 2000 The currency composition of foreign exchange reserves: Retrospect and prospect *IMF Working Paper 00/131 International Monetary Fund Washington DC USA*.
- 828.** Greenspan A (October) 2000 Remarks [on e-finance] *9th Annual Financial Markets Conference of the Federal Reserve Bank of Atlanta USA*.
- 829.** Hufner F P 2000 The British foreign exchange reserves puzzle *ZEW Discussion Papers no 00-55 ZEW - Zentrum für Europäische Wirtschaftsforschung / Center for European Economic Research* <http://hdl.handle.net/10419/24403> .
- 830.** Fujiwara I (June) 2000 Liquidity and leverage risk in the Dollar/Yen market *Typescript Nuffield College Oxford UK*.
- 831.** Kanas A 2000 Volatility spillovers between stock returns and exchange rate changes: International evidence *Journal of Business Finance and Accounting* **27** pp 447 – 467.
- 832.** Kaul A, Mehrotra V, Morck R 2000 Demand curves for stock do slope down: New evidence from an index weights adjustment *Journal of Finance* **55** pp 893 – 912.

- 833.** Kim S-J, Kortian T, Sheen J 2000 Identifying central bank intervention and exchange rate volatility – Australian evidence *Journal of International Financial Markets Institutions and Money* vol **10** pp 381 – 405.
- 834.** Kim S-J, Sheen J 2002 The determinants of foreign exchange intervention by central banks: Evidence from *Australia Journal of International Money and Finance* vol **21** pp 619 – 649.
- 835.** Kim S-J 2003 Monetary policy, foreign exchange intervention, and the exchange rate in a unifying framework *Journal of International Economics* **60** pp 355 – 386.
- 836.** Lane Ph R, and Milesi-Ferretti G M 2000 The transfer problem revisited: Net foreign assets and real exchange rates *Hong Kong Institute for Monetary Research Working Paper 6/2000*.
- 837.** Lo Ch-K (editor) 2000 Financial markets in Hong Kong *Springer* Singapore.
- 838.** Lee C, Swaminathan B 2000 Price momentum and trading volume *The Journal of Finance* **55** pp 2017 – 2069.
- 839.** Ma Y, Kanas A 2000 Testing nonlinear relationship among fundamentals and exchange rates in the ERM *Journal of International Money and Finance* **19** (1) pp 135 – 152.
- 840.** Ma Y, Tsang Sh-K, Yiu M S, Wai-Yip Alex Ho 2010 A target-zone model with two types of assets *Working Paper* Hong Kong Institute for Monetary Research Hong Kong P R China.
- 841.** Martin A D 2000 Exchange rate exposure of the key financial institutions in the foreign exchange market *International Review of Economics and Finance* **9** (3) pp 267 – 286.
- 842.** Martin A D, Mauer L J 2003 Exchange rate exposures of US banks: A cash flow-based methodology *Journal of Banking and Finance* **27** (5) pp 851 – 865.
- 843.** Martin A D, Mauer L J 2005 A note on common methods used to estimate foreign exchange exposure *Journal of International Financial Markets, Institutions & Money* **15** (2) pp 125 – 140.
- 844.** McCallum B (April) 2000 Theoretical analysis regarding a zero lower bound on nominal interest rates *NBER Working Paper no 7677* NBER USA.
- 845.** Melvin M, Yin X 2000 Public information arrival, exchange rate volatility, and quote frequency *Economic Journal* **110** pp 644 – 661.
- 846.** Melvin M, Melvin B P 2003 The global transmission of volatility in the foreign exchange market *The Review of Economics and Statistics* **85** pp 670 – 679.
- 847.** Melvin M, Taylor M P 2009 The crisis in the foreign exchange market *Journal of International Money and Finance* **28** (8) pp 1317 – 1330.

- 848.** Naranjo A, Nimalendran M 2000 Government intervention and adverse selection costs in foreign exchange markets *Review of Financial Studies* **13** pp 453 – 477.
- 849.** Ng A 2000 Volatility spillover effects from Japan and the US to the Pacific-Basin *Journal of International Money and Finance* **19** pp 207 – 233.
- 850.** Ramaswamy R, Samiei H (June) 2000 The Yen-Dollar rate: Have interventions mattered? *IMF Working Paper no 00/95* IMF USA.
- 851.** Rime D (March) 2000 Private or public information in foreign exchange markets? An empirical analysis *Typescript* University of Oslo Norway www.uio.no/~dagfinri .
- 852.** Rime D 2001 Private or public information in foreign exchange markets? An empirical analysis *Typescript* Central Bank of Norway Oslo Norway.
- 853.** Rime D 2003 New electronic trading systems in the foreign exchange markets *in* New economy handbook Jones D C (editor) chap 21 *Academic Press* San Diego USA pp 471 – 504.
- 854.** Akram Q, Rime D, Sarno L (February) 2005 Arbitrage in the foreign exchange market: Turning on the microscope *Working Paper no 2005/12* Norges Bank Norway.
- 855.** Rime D, Sarno L, Sojli E 2006 Exchange rate dynamics and order flow: A step beyond *Typescript* Warwick University UK.
- 856.** Rime D, Sarno L, Sojli E 2007 Exchange rate forecasting, order flow and macroeconomic information *Working Paper no 2* Norges Bank Norway.
- 857.** Rime D, Sarno L, Sojli E 2010 Exchange rate forecasting, order flow and macroeconomic information *Journal of International Economics* **80** (1) pp 72 – 88.
- 858.** Schwartz A J 2000 The rise and fall of foreign exchange market intervention *NBER Working Paper W7751* National Bureau of Economic Research Cambridge MA USA.
- 859.** US General Accounting Office (May) 2000 On-line trading: Better investor protection information needed on brokers' web sites *US General Accounting Office* USA.
- 860.** Allayannis G, Ofek E 2001 Exchange rate exposure, hedging, and the use of foreign currency derivatives *Journal of International Money and Finance* **20** pp 273 – 296.
- 861.** Anderson H, Vahid F 2001 Market architecture and nonlinear dynamics of Australian stock and futures indices *Australian Economic Papers* **40** (4) pp 541 – 566.
- 862.** Brandt M W, Edelen R, Kavajecz K A 2001 Liquidity in the US treasury market: Asymmetric information and inventory effects *Manuscript* Department of Finance The Wharton School University of Pennsylvania USA.
- 863.** Brown G W 2001 Managing foreign exchange risk with derivatives *Journal of Financial Economics* **60** pp 401 – 448.

- 864.** Cai J, Cheung Y - L, Lee R S K, Melvin M 2001 Once-in-a-generation Yen volatility in 1998: Fundamentals, intervention, and order flow *Journal of International Money and Finance* **20** (3) pp 327 – 347.
- 865.** Claessens S, Forbes K 2001 International and financial contagion *Springer*.
- 866.** Clark T, McCracken M 2001 Evaluating long-horizon forecasts *Working Paper no 01-14* Federal Reserve Bank of Kansas City USA.
- 867.** Collins S, Rodrik D (editors) 2001 Brookings Trade Forum 2001 *Brookings Institution Press* Washington DC USA.
- 868.** Corsetti G, Pesenti P, Roubini N (May) 2001 Does one Soros make a difference? The role of a large trader in currency crises *NBER Working Paper 8303* NBER USA, *Review of Economic Studies*.
- 869.** Coval J D, Shumway T 2001 Is sound just noise? *The Journal of Finance* **56** pp 1887 – 1910.
- 870.** Croushore D, Stark T 2001 A real-time data set for macroeconomists *Journal of Econometrics* **105** pp 111 – 130.
- 871.** Dacorogna M M, Gencay R, Mueller U A, Olsen R B, Pictet O V 2001 An introduction to high-frequency finance *Academic Press* San Diego CA USA.
- 872.** D'Souza C (March) 2001 A market-microstructure analysis of FX intervention in Canada *Working Paper* Financial Markets Division Bank of Canada Ottawa Canada.
- 873.** Duarte M, Stockman A (July) 2001 Rational speculation and exchange rates *NBER Working Paper 8362* NBER USA.
- 874.** Fischer S 2001 Exchange rate regimes: Is the bipolar view correct? *Finance and Development* 2/2001 *IMF* Washington USA <http://www.imf.org>.
- 875.** Galati G 2001 Why has global FX turnover declined? Explaining the 2001 triennial survey *BIS Quarterly Review* (December) pp 39 – 47.
- 876.** Griffin J M, Stulz R M 2001 International competition and exchange rate shocks: A cross-country industry analysis of stock returns *Review of Financial Studies* **14** pp 215 – 241.
- 877.** Guembel A, Sussman O 2001 Optimal exchange rates: A market-microstructure approach *Typescript* Said Business School Oxford University Oxford UK.
- 878.** Hong Y 2001 A test for volatility spillover with application to exchange rates *Journal of Econometrics* **103** pp 183 – 224.
- 879.** Lane P 2001 The new open-economy macroeconomics: A survey *Journal of International Economics* **54** pp 235 – 266.

- 880.** Montgomery J D, Popper H A 2001 Information sharing and central bank intervention in the foreign exchange market *Journal of International Economics* **55** pp 295 – 316.
- 881.** Moore M, Roche M (May) 2001 Liquidity in the forward exchange market *Journal of Empirical Finance* **8** pp 157 – 170.
- 882.** Moore M, Roche M 2002 Less of a puzzle: A new look at the forward forex market *Journal of International Economics* **58** pp 387 – 411.
- 883.** Rey H 2001 International trade and currency exchange *Review of Economic Studies* **68** pp 443 – 464.
- 884.** Sato S, Hawkins J 2001 Electronic finance: An overview of the issues *BIS Paper no 7* Switzerland.
- 885.** Sinn H, Westermann F (July) 2001 Why has the euro been falling? An investigation into the determinants of the exchange rate *NBER Working Paper 8352* NBER USA.
- 886.** Tse Y, Zobotina T 2001 Transaction costs and market quality: Open outcry versus electronic trading *Journal of Futures Markets* **21** (8) pp 713 – 735.
- 887.** Williamson R 2001 Exchange rate exposure and competition: Evidence from the automotive industry *Journal of Financial Economics* **59** pp 441 – 475.
- 888.** Yamaguchi Y 2001 The implications of electronic trading in financial markets *Committee on the Global Financial System* Bank for International Settlements ISBN 92-9131-613-X pp 1 – 37.
- 889.** Aguiar M (March) 2002 Informed speculation and the choice of exchange rate regime *Typescript* University of Chicago USA.
- 890.** Beine M et al 2002 Central bank intervention and foreign exchange rates: New evidence from FIGARCH estimations *Journal of International Money and Finance* **21**.
- 891.** Cavallo M, Perri F, Roubini N, Kisselev K (March) 2002 Exchange rate overshooting and the costs of floating *Typescript* New York University.
- 892.** Chari V, Kehoe P, McGrattan E 2002 Can sticky price models generate volatile and persistent real exchange rates? *Review of Economic Studies* **69** pp 533 – 564.
- 893.** Chari A 2006 Heterogeneous market making in foreign exchange markets: Evidence from individual bank responses to central bank interventions *Journal of Money, Credit, and Banking*.
- 894.** Chordia T, Roll R, Subrahmanyam A 2002 Order imbalance, liquidity, and market returns *Journal of Financial Economics* **65** (1) pp 111 – 130.
- 895.** Daníelsson J, Payne R 2002 Real trading patterns and prices in spot foreign exchange markets *Journal of International Money and Finance* **21** (2) pp 203 – 222.

- 896.** Danielsson J, Payne R, Luo J (July) 2002 Exchange rate determination and inter-market order flow effects *Typescript* Financial Markets Group London School of Economics and Political Science London UK.
- 897.** Danielsson J, Love R 2006 Feedback trading *International Journal of Finance and Economics* **11** (1) pp 35 – 53.
- 898.** Danielsson J, Payne R 2011 Liquidity determination in an order-driven market *European Journal of Finance*.
- 899.** Deutsche Bundesbank (January) 2002 Capital flows and the exchange rate *Deutsche Bundesbank Monthly Report* pp 15 – 26.
- 900.** Doyne F J, Joshi Sh 2002 The price dynamics of common trading strategies *Journal of Economic Behavior and Organization* **49** pp 149 – 171.
- 901.** Fatum R, Hutchison M 2002 Is foreign exchange intervention an alternative to monetary policy? Evidence from Japan *Working Paper 02-11* Department of Economics University of Copenhagen Denmark.
- 902.** Fatum R, King M R 2005 Rules versus discretion in foreign exchange intervention: Evidence from official Bank of Canada high-frequency data *Working Paper 05-06* Department of Economics University of Copenhagen Denmark.
- 903.** King M R, Sarno L, Sojli E 2010 Timing exchange rates using order flow: The case of the Loonie *Journal of Banking and Finance* **34** (12) pp 2917 – 2928.
- 904.** King M R, Rime D 2010 The \$4 trillion question: What explains FX growth since the 2007 survey? *BIS Quarterly Review* **4** pp 27 – 42.
- 905.** King M R, Mallo C 2010 A user's guide to the Triennial Central Bank Survey of foreign exchange market activity *BIS Quarterly Review* **4** pp 71 – 83.
- 906.** King M R, Osler C, Rime D 2011 Instruments, players and the foreign exchange trading environment' in *The handbook of exchange rates* James J, Marsh I W, Sarno L (editors) *John Wiley & Sons Inc* USA.
- 907.** King M R, Osler C, Rime D 2011 Foreign exchange market structure, players and evolution *Working Paper no 2011 / 10* Norges Bank Oslo Norway ISSN 1502-8143 ISBN 978-82-7553-616-5 pp 1 – 47.
- 908.** King M R, Osler C, Rime D 2012 The market microstructure approach to foreign exchange: Looking back and looking forward *Working Paper 2012 / 54* Ivey Business School University of Western Ontario, Brandeis International Business School Brandeis University, Norges Bank Oslo Norway pp 1 – 40.

909. Kantelhardt J, Zschiegner St, Koscielny-Bunde E, Havlin Sh, Bunde A, Stanley E 2002 Multifractal de-trended fluctuation analysis of nonstationary time series *Physica A* **316** pp 87 – 114.
910. Galati G 2002 Settlement risk in foreign exchange markets and CLS Bank *BIS Quarterly Review* **4** pp 55 – 65.
911. Girardin E, Horsewood N 2002 New transmission mechanisms and instruments of monetary policy at near zero interest rates: The case of Japan in the 1990s in Essays in honour of Maxwell J. Fry Dickinson D, Mullineux A (editors) *Edward Elgar* UK.
912. Huang R, Cai J, Wang X 2002 Information-based trading in the interdealer market *Journal of Financial Intermediation* **11** pp 269 – 296.
913. Jeanne O, Rose A 2002 Noise trading and exchange rate regimes *Quarterly Journal of Economics* **117** pp 537 – 569.
914. Kaul A, Mehrotra V (June) 2002 Ticker or trade? How prices adjust in international markets *Typescript* University of Alberta Edmonton Alberta Canada.
915. Obadan M I 2002 Towards exchange rate stability in Nigeria *The Year 2002 One-Day Seminar of the Nigerian Economic Society (NES)* Federal Palace Hotel Lagos Nigeria.
916. Ryan S, Worthington A C 2002 Time-varying market, interest rate and exchange rate risk in Australian Bank portfolio stock returns: A GARCH-M approach *Discussion Papers and Working Paper Series no 112* School of Economics and Finance Queensland University of Technology Brisbane Queensland Australia.
917. Abreu D, Brunnermeier M K 2003 Bubbles and crashes *Econometrica* **71** (1) pp 173 – 204.
918. Aliber R Z, Chowdry B, Yan S 2003 Some evidence that a Tobin tax on foreign exchange transactions may increase volatility *European Finance Review* **7** pp 481 – 510.
919. Bacchetta P, van Wincoop E (February) 2003 Can information dispersion explain the exchange rate disconnect puzzle? *NBER Working Paper 9498* NBER USA.
920. Bergsten C F, Williamson J (editors) 2003 Dollar overvaluation and the World economy *Institute for International Economics* Washington DC USA.
921. Bergsten C F, Williamson J (editors) 2005 Dollar adjustment: How far? Against what? *Institute of International Economics* Washington DC USA.
922. Bodnar G M, Wong M H F 2003 Estimating exchange rate exposures: Issues in model structure *Financial Management* **32** pp 35 – 67.

923. Burstein A T, Neves J, Rebelo S (September) 2003 Distribution costs and real exchange rate dynamics during exchange rate-based stabilizations *Journal of Monetary Economics* vol 50 (6) pp 1189 – 1214.
924. Carpenter A, Wang J (January) 2003 Sources of private information in FX trading *Typescript* University of New South Wales Sydney Australia.
925. Choi C, Baek S-G 2004 Exchange rate regimes and international reserves *Working Paper*.
926. Derviz A 2003 Asset return dynamics and the FX risk premium in a decentralized dealer market *Typescript* Czech National Bank, *European Economic Review*.
927. Dominguez K M E 2003 The market microstructure of central bank intervention *Journal of International Economics* 59 pp 25 – 45.
928. Dominguez K M E, Panthaki F 2006 What defines “News” in foreign exchange markets? *Journal of International Money and Finance* 25 pp 168 – 198.
929. Doukas J A, Hall P H, Lang L H P 2003 Exchange rate exposure at the firm and industry level *Financial Markets, Institutions & Instruments* 12 (5) pp 291 – 347.
930. Fatum R, Hutchison M M 2003 Is sterilized foreign exchange intervention effective after all? An event study approach *Economic Journal* 113 pp 390 – 411.
931. Fatum R, Hutchison M M 2006 Effectiveness of official daily foreign exchange market operations in Japan *Journal of International Money and Finance* 25 pp 199 – 219.
932. Faust J, Rogers J H, Wright J H 2003 Exchange rate forecasting: The errors we’ve really made *Journal of International Economics* 60 (1) pp 35 – 59.
933. Gordon M 2003 Estimates of time-varying term premia for New Zealand and Australia *Discussion Paper Series DP2003/06* Reserve Bank of New Zealand New Zealand.
934. Humpage O F 2003 Government intervention in the foreign exchange market *Federal Reserve Bank of Cleveland Working Paper 0315* USA.
935. Koutmos G, Martin A D 2003 Asymmetric exchange rate exposure: theory and evidence *Journal of International Money and Finance* 22 (3) pp 365 – 384.
936. Laurenceson J, Chai J C H 2003 Financial reform and economic development in China *Edward Elgar* Cheltenham UK.
937. Mathisen J 2003 Estimation of the equilibrium real exchange rate for Malawi *IMF Working papers 03/104* IMF USA.
938. Okunev J, White D 2003 Do momentum-based strategies still work in foreign currency markets? *Journal of Financial and Quantitative Analysis* 38 pp 425 – 447.

939. Peng W, Shu Ch, Chow K (May) 2003 The Yen exchange rate and net foreign assets *Research Department Economic Research Division Hong Kong Monetary Authority* pp 1 – 19.
940. Rogers J M, Siklos P L 2003 Foreign exchange market intervention in two small open economies: The Canadian and Australian experience *Journal of International Money and Finance*.
941. Spiegel M 2003 Japanese foreign exchange intervention *Federal Reserve Bank of San Francisco Newsletter* 2003-36 San Francisco USA.
942. Westerhoff F H 2003 Market-maker, inventory control and foreign exchange dynamics *Quantitative Finance* **83** (3) pp 363 – 369.
943. Wright J H 2003 Bayesian model averaging and exchange rate forecasts *International Finance Discussion Papers no 779* Board of Governors of the Federal Reserve System USA.
944. Aitken M, Frino A, Hill A, Jarnecic E 2004 The impact of electronic trading on bid - ask spreads: Evidence from futures markets in Hong Kong, London, and Sydney *Journal of Futures Markets* **24** (7) pp 675 – 696.
945. Anwar T 2004 Recent macroeconomic developments and implications for poverty and employment in Pakistan: The cost of foreign exchange reserve holdings in South Asia Australia South Asia *ASARC Working Paper 2004-14 2* Research Centre The Research School of Pacific & Asian Studies The National Institute of Economics and Business Australian National University Canberra Australia pp 1 – 23.
946. Bacchetta P, van Wincoop E (January) 2004 A scapegoat model of exchange rate fluctuation *NBER Working Paper 10245* NBER USA.
947. Bacchetta P, van Wincoop E 2006 Can information dispersion explain the exchange rate disconnect puzzle? *American Economic Review* **93** pp 552 – 576.
948. Bartram S M 2004 Linear and nonlinear foreign exchange rate exposures of German nonfinancial corporations *Journal of International Money and Finance* **23** (4) pp 673 – 699.
949. Bartram S M, Bodnar G M 2004 The foreign exchange exposure puzzle *Johns Hopkins University Working Paper* USA.
950. Bartram S M, Brown G, Minton B 2005 Resolving the exposure puzzle: The many facets of exchange rate exposure *Working Paper* Lancaster University UK, University of North Carolina at Chapel Hill, Ohio State University USA.
951. Bartram S M, Karolyi G A 2006 The impact of the introduction of the Euro on foreign exchange rate risk exposures *Journal of Empirical Finance* **13** (4-5) pp 519 – 549.

- 952.** Bhanumurthy N R 2004 Microstructures in the Indian foreign exchange market *Working Paper* Delhi University India.
- 953.** Brandt M W, Kavajecz K A 2004 Price discovery in the US treasury market: The impact of order flow and liquidity on the yield curve *Journal of Finance* **59** (6) pp 2623 – 2654.
- 954.** Breedon F, Vitale P 2004 An empirical study of information and liquidity effects of order flow on exchange rates *CEPR Working Paper* 4586.
- 955.** Cashin P, Cespedes L, Sahay R 2004 Commodity currencies and the real exchange rate *Journal of Development Economics* vol **75** pp 239 – 268.
- 956.** De Wet W A, Gebreselasie T G 2004 The exchange rate exposure of major commercial banks in South Africa *The African Finance Journal* **6** (2) pp 21 – 35.
- 957.** Dunne P, Hau H, Moore M (November) 2004 Macroeconomic order flows: Explaining equity and exchange rate returns *Typescript*.
- 958.** Fratzscher M 2004 Exchange rate policy strategies and foreign exchange interventions in the group of three economies in Dollar adjustment: How far? Against what? Bergsten C F, Williamson J (editors) *Institute for International Economics* Washington DC USA.
- 959.** Hahn J H 2004 Interest rate and exchange rate exposures of banking institutions in pre-crisis Korea *Applied Economics* **36** (13) pp 1409 – 1419.
- 960.** Hui Ch-H, Neely Ch J, Higbee J (November) 2004, (June) 2007 Foreign exchange volatility is priced in equities *Working Paper 2004-029F* Research Division Federal Reserve Bank of St Louis MO USA <http://research.stlouisfed.org/wp/2004/2004-029.pdf> pp 1 – 39.
- 961.** Hui Ch-H, Yeung V, Fung L, Lo Ch-F 2007 Valuing foreign currency options with a mean-reverting process: a study of Hong Kong dollar *Working Paper 08/2007* Research Department Market Research Division Hong Kong Monetary Authority Hong Kong P R China, Physics Department The Chinese University of Hong Kong P R China pp 1 – 28.
- 962.** Hui Ch-H, Fong T 2007 Is the Hong Kong dollar exchange rate “bounded” in the convertibility zone? *Working Paper 13/2007* Research Department Market Research Division Hong Kong Monetary Authority Hong Kong P R China pp 1 - 14.
- 963.** Hui Ch-H, Genberg H, Chung T-K 2009 Liquidity, risk appetite and exchange rate movements during the financial crisis of 2007-2009 *Working Paper 11/2009* Research Department Market Research Division Hong Kong Monetary Authority Hong Kong P R China pp 1 – 23.
- 964.** Kim K, Yoon S-M 2004 Multifractal features of financial markets *Physica A* **344** pp 272 – 278.

965. Nagayasu J 2004 The effectiveness of Japanese foreign exchange interventions during 1991-2001 *Economics Letters* **84** pp 377 – 381.
966. National Bank of Poland 2004 Turnover in the Polish foreign exchange and OTC derivatives markets in April 2004 Result Summary *National Bank of Poland* Warsaw Poland.
967. National Bank of Poland 2007 Turnover in the Polish foreign exchange and OTC derivatives markets in April 2007 Result Summary *National Bank of Poland* Warsaw Poland.
968. Reinhart C M, Rogoff K S 2004 The modern history of exchange rate arrangements: A reinterpretation *Quarterly Journal of Economics* **119** (1) pp 1 – 48.
969. Rigobon R, Sack B 2004 The impact of monetary policy on asset prices *Journal of Monetary Economics* **51** pp 1553 – 1575.
970. Simatele M 2004 Foreign exchange intervention and the exchange rate in Zambia *Economics Studies Goteborg University* Sweden.
971. Akram Q F, Rime D, Sarno L 2005 Arbitrage in the foreign exchange market: Turning on the microscope *Working Paper ANO 2005/12* ISSN 0801-2504 (printed) 1502-8143 (online) Norges Bank Oslo Norway.
972. Ates A, Wang G H 2005 Information transmission in electronic versus open-outcry systems: An analysis of US equity index futures markets *Journal of Futures Markets* **25** (7) pp 679 – 715.
973. Bauwens L, Omrane W B, Giot P 2005 News announcements, market activity and volatility in the euro/dollar foreign exchange market *Journal of International Money and Finance* **24** (7) pp 1108 – 1125.
974. Campa J M, Goldberg L S 2005 Exchange rate pass through into import prices *Review of Economics and Statistics November* **87** (4) pp 679 – 690.
975. Campa J M, Goldberg L S 2006a Distribution margins, imported inputs, and the sensitivity of the CPI to exchange rates *NBER Working Paper no 12121* NBER USA.
976. Campa J M, Goldberg L S 2006b Pass-through of exchange rates to consumption prices: What has changed and why? *Working Paper* Federal Reserve Bank of New York USA.
977. Chui M, Gerlach S, Yu I W 2005 The recent appreciation of the Hong Kong dollar *BIS Papers* **23** pp 150 – 155.
978. DeGrauwe P (editor) 2005 Exchange rate economics: Where do we stand? *MIT Press* Cambridge USA.
979. Dueker M, Neely Ch J 2005 Can Markov switching models predict excess foreign exchange returns? *Journal of Banking and Finance*.

- 980.** Eichengreen B 2005 Sterling's past, Dollar's future: Historical perspectives on reserve currency competition *NBER Working Paper no 11336* National Bureau of Economic Research Cambridge MA USA.
- 981.** Fung J K W, Lien D, Tse Y M, Tse Y K 2005 Effects of electronic trading on the Hang Seng index futures market international *Review of Economics and Finance* **14** (4) pp 415 – 425.
- 982.** Hau H, Rey H 2005 Exchange rates, equity prices and capital flows *Review of Financial Studies*.
- 983.** Hull J C (2005-2006) Private communications on the electronic trading strategies in the foreign currencies exchange markets *Electronic Trade Laboratory Rotman School of Management* University of Toronto Canada.
- 984.** Hull J C 2012a Options, futures, and other derivatives *Prentice Hall* 8th edition ISBN: 0-13-216484-9 USA pp 1 – 816.
- 985.** Hull J C 2012b Risk management and financial institutions *John Wiley and Sons Inc* 3rd edition ISBN: 978-1-1182-6903-9 USA pp 1 – 672.
- 986.** Hull J C 2010 Fundamentals of futures and options markets *Prentice Hall* 7th edition ISBN-10: 0136103227 ISBN-13: 978-0136103226 USA pp 1 – 624.
- 987.** Inoue A, Kilian L 2005 In-sample or out-of-sample tests of predictability: Which one should we use? *Econometric Reviews* **23** (4) pp 371 – 402.
- 988.** Marsh I W, O'Rourke C 2005 Customer order flow and exchange rate movements: Is there really information content? *Working Paper* Cass Business School UK.
- 989.** Newsome J 2006 La criée ou le tout électronique: Le marché décide *Revue D'économie Financière* pp 1 – 5.
- 990.** Vaubel R 2005 Foreign exchange accumulation by emerging and transition economies: An explanation and critique *in* Aspekte der internationalen ökonomie El-Shagi M, Rübel G (editors) *Wiesbaden Gabler* Germany pp 77 – 84.
- 991.** Yu I-W, Fung L, Hongyi Ch (November) 2005 Exchange rate risk premiums in Hong Kong dollar: A signal-extraction approach *Research Department Economic Research Division* Hong Kong Monetary Authority pp 1 – 16.
- 992.** Alexander K, Barbosa A 2006 The impact of electronic trading and exchange traded funds on the effectiveness of minimum variance hedging *ICMA Centre Discussion Paper in Finance DP2006-04* University of Reading UK pp 1 – 23.
- 993.** Bacchetta P, van Wincoop E 2006 Can information heterogeneity explain the exchange rate determination puzzle? *American Economic Review* **96** (3) pp 552 – 576.

- 994.** Bayoumi T, Lee J, Jayanthi S 2006 New rates from new weights IMF Staff Papers vol **53** no 2 *IMF* Washington USA.
- 995.** Boyen M M, Van Norden S 2006 Exchange rates and order flow in the long run *Finance Research Letters* **3** (4).
- 996.** Cai F, Howorka E, Wongswan J 2006 Transmission of volatility and trading activity in the global interdealer foreign exchange market: Evidence from electronic broking services (EBS) data *International Finance Discussion Papers* Board of Governors of the Federal Reserve System USA.
- 997.** Cai F, Howorka E, Wongswan J 2008 Informational linkages across trading regions: Evidence from foreign exchange markets *Journal of International Money and Finance* **27** (8) pp 1215 – 1243.
- 998.** Cao H H, Evans M D D, Lyons R K 2006 Inventory information *Journal of Business* **79** (1) pp 325 – 364.
- 999.** Carlson J A, Lo M 2006 One minute in the life of the DM/US\$: Public news in an electronic market *Journal of International Money and Finance* **25** (7) pp 1090 – 1102.
- 1000.** Charlebois M, Sapp St 2006 Temporal patterns in foreign exchange returns and options *Richard Ivey School of Business* University of Western Ontario Canada.
- 1001.** Chu C, Mo Y K, Wong G, Lim P 2006 Financial integration in Asia *Hong Kong Monetary Authority Quarterly Bulletin* **49**.
- 1002.** Gilbert C, Rijken H 2006 How is futures trading affected by the move to a computerized trading system? Lessons from the LIFFE FTSE 100 contract *Journal of Business Finance and Accounting* pp 1 – 31.
- 1003.** Jeon J, Oh Y, Yang D Y 2006 Financial market integration in East Asia: Regional or global *Asian Economic Papers* **5** (1) pp 73 – 89.
- 1004.** Escribano A, Pascual R 2006 Asymmetries in bid and ask responses to innovations in the trading process *Empirical Economics* **30** pp 913 – 946.
- 1005.** Kaul A, Sapp S 2006 Y2K fears and safe haven trading of the US dollar *Journal of International Money and Finance* **25** (5) pp 760 – 779.
- 1006.** Killeen W P, Lyons R K, Moore M J 2006 Fixed versus flexible: Lessons from EMS order flow *Journal of International Money and Finance* **25** (4) pp 551 – 579.
- 1007.** Kim S, Lee J W, Shin K 2006 Regional and global financial integration in East Asia *Working Paper Series 0602* Institute of Economic Research Korea University South Korea.
- 1008.** Kočenda E, Valachy J 2006 Exchange rate volatility and regime change: Visegrad comparison *Journal of Comparative Economics* **34** (4) pp 727 – 753.

- 1009.** Kočenda E, Kutan A M, Yigit T 2008 Fiscal convergence in the European Union *North-American Journal of Economics and Finance* **19** (3) pp 319 – 330.
- 1010.** Kočenda E, Poghosyan T 2009 Macroeconomic sources of foreign exchange risk in new EU members *Journal of Banking and Finance* **33** (11) pp 2164 – 2173.
- 1011.** LeBaron B 2006 Agent-based computational finance vol **2** Tesfatsion L, Judd K L (editors) *North-Holland Publishing Company / Elsevier* Amsterdam The Netherlands.
- 1012.** Mende A 2006 09/11 on the USD/EUR foreign exchange market *Applied Financial Economics* **16** (3) pp 213 – 222.
- 1013.** Mende A, Menkhoff L 2006 Profits and speculation in intra-day foreign exchange trading *Journal of Financial Markets* **9** (3) pp 223 – 245.
- 1014.** Muller A, Verschoor W F C 2006 Foreign exchange risk exposure: Survey and suggestions *Journal of Multinational Financial Management* **16** (4) pp 385 – 410.
- 1015.** Norouzzadeh P, Rahmani B A 2006 Multifractal de-trended fluctuation description of Iranian-US dollar exchange rate *Physica A* **367** pp 328 – 336.
- 1016.** Pelham M 2006 Automation creates level playing field for FX traders *The Banker* (August) pp 30 – 33.
- 1017.** Rodrik D 2006 The social cost of foreign exchange reserves *NBER Working Paper no 11952* National Bureau of Economic Research Cambridge MA USA.
- 1018.** Sager M J, Taylor M P 2006 Under the microscope: The structure of the foreign exchange market *International Journal of Finance and Economics* **11** (1) pp 81 – 95.
- 1019.** Starks L T, Wei K D 2006 Foreign exchange rate exposure and short-term cash flow sensitivity *Working Paper* University of Texas TX USA.
- 1020.** Tabak B, Cajueiro D 2006 Assessing inefficiency in euro bilateral exchange rates *Physica A* **367** pp 319 – 327.
- 1021.** Taylor A, Farstrup A 2006 Active currency management: Arguments, considerations, and performance for institutional investors *CRA Rogers Casey International Equity Research* Darien Connecticut USA.
- 1022.** Taylor J B (September 14) 2006 Lessons from the recovery from the ‘lost decade’ in Japan: The case of the great intervention and money injection *ESRI international Conference* Cabinet Office Government of Japan Tokyo Japan.
- 1023.** Tesfatsion L, Judd K L (editors) 2006 *North-Holland Publishing Company / Elsevier* Amsterdam The Netherlands.

- 1024.** Wong A 2006 Analyzing foreign exchange reserve diversification *Institute for International Economics Working Paper* Institute for International Economics Washington DC USA.
- 1025.** Adebisi M A (July) 2007 An evaluation of foreign exchange intervention and monetary aggregates in Nigeria (1986 - 2003) *Department of Economics* University of Lagos Nigeria *MPRA Paper no 3817* pp 1 – 21 <http://mpa.ub.uni-muenchen.de/3817/> .
- 1026.** Barker W 2007 The global foreign exchange market: Growth and transformation *Bank of Canada Review* (Autumn) pp 3 – 12.
- 1027.** Bhansali V 2007 Volatility and the carry trade *Journal of Fixed Income* **17** (3) pp 72 - 84.
- 1028.** Broz J L, Frieden J, Weymouth S 2007 Exchange rate policy attitude: Direct evidence from survey data *IMF* Washington USA <http://www.imf.org> .
- 1029.** Burnside C, Eichenbaum M S, Rebelo S 2007 The returns to currency speculation in emerging markets *American Economic Review Papers and Proceedings* **97** (2) pp 333 – 338.
- 1030.** Burnside C, Eichenbaum M S, Rebelo S 2009 Understanding the forward premium puzzle: A microstructure approach *American Economic Journal: Macroeconomics* **1** (2) pp 127 – 154.
- 1031.** Burnside C 2012 Carry trades and risk *in* The handbook of exchange rates James J, Marsh I W, Sarno L (editors) *John Wiley & Sons Inc.* USA.
- 1032.** Canto B, Kräussl R 2007 Electronic trading systems and intraday non-linear dynamics: An examination of the FTSE 100 cash and futures returns *CFS Working Paper no 2007/20* Center for Financial Studies an der Johann Wolfgang Goethe-Universität Frankfurt am Main Leibniz Information Centre for Economics Germany pp 1 – 45 <http://hdl.handle.net/10419/25521> www.ifk-cfs.de www.econstor.eu .
- 1033.** Chi J, Tripe D, Young M (24-25 September) 2007 Do exchange rate affect the stock performance of Australian Banks? 12th Finsia-Melbourne Centre for Financial Studies Banking and Finance Conference Melbourne Australia.
- 1034.** Christodoulou G, O'Connor P 2007 The foreign exchange and over-the-counter derivatives markets in the United Kingdom *Bank of England Quarterly Bulletin* (Q4) pp 548 – 563.
- 1035.** Dreher A, Vaubel R 2007 Foreign exchange intervention and the political business cycle: A panel data analysis *KOF Working Paper 159* KOF Swiss Economic Institute Swiss Federal Institute of Technology Zurich Switzerland pp 1 – 28 www.kof.ethz.ch .
- 1036.** DuCharme M 2007 First steps in foreign exchange transaction cost analysis *Journal of Performance Measurement* pp 19 – 27.

- 1037.** Egstrup R, Fischer B D (4th Quarter) 2007 Foreign exchange and derivatives markets in 2007 Monetary review *Danmarks Nationalbank* Copenhagen Denmark
[http:// www. natioanlbanken.dk/DNUK/Publications.nsf](http://www.natioanlbanken.dk/DNUK/Publications.nsf) .
- 1038.** Fleming M J, Mizrach B 2007 The microstructure of a US treasury ECN: The BrokerTec platform pp 1 – 40 <http://ssrn.com/abstract=1433488> .
- 1039.** Fung L, Yu I W 2007 Assessing the credibility of the convertibility zone of the Hong Kong dollar *Working Paper 19/2007* Hong Kong Monetary Authority Hong Kong P R China.
- 1040.** Genberg H, He D, Leung F 2007 Recent performance of the Hong Kong dollar linked exchange rate system *Research Note 02/2007* Hong Kong Monetary Authority Hong Kong P R China.
- 1041.** Genberg H, He D, Leung F 2007 The ‘Three refinements’ of the Hong Kong dollar linked exchange rate system two years on *Hong Kong Monetary Authority Quarterly Bulletin 51* pp 5 – 11.
- 1042.** Genberg H, Hui C H 2009 The credibility of the LINK from the perspective of modern financial theory *Working Paper 02/2009* Hong Kong Monetary Authority Hong Kong P R China.
- 1043.** Hong Kong Monetary Authority (December) 2007 The foreign exchange and derivatives markets in Hong Kong *Hong Kong Monetary Authority Quarterly Bulletin* Hong Kong P R China.
- 1044.** Jiang J, Ma K, Cai X 2007 Scaling and correlations in foreign exchange market *Physica A 375* pp 274 – 280.
- 1045.** Leung F, Ng P 2007 Is the Hong Kong dollar real exchange rate misaligned? *Working Paper 21/2007* Research Department Market Research Division Hong Kong Monetary Authority Hong Kong P R China pp 1 – 31.
- 1046.** Leung F, Ng P 2008 Impact of IPO activities on the Hong Kong dollar interbank market *Working Paper 2008-11* Hong Kong Monetary Authority Hong Kong P R China.
- 1047.** Mitchell M, Pedersen L H, Pulvino T 2007 Slow moving capital *American Economic Review 97* (2) pp 215 – 220.
- 1048.** Pasquariello P 2007 Informative trading or just costly noise? An analysis of central bank interventions *Journal of Financial Markets 10* pp 107 – 143.
- 1049.** Sahminan S 2007 Effects of exchange rate depreciation on commercial bank failures in Indonesia *Journal of Financial Stability 3* (2) pp 175 – 193.

- 1050.** Scarlat E, Stan Cr, Cristescu C 2007 Self-similar characteristics of the currency exchange rate in an economy in transition *Physica A* **370** pp 188 – 198.
- 1051.** Van Wincoop E, Tille C 2007 International capital flows *NBER Working Paper 33* NBER USA.
- 1052.** Wong J, Wong E, Fong T, Choi K-F 2007 Testing for collusion in the Hong Kong banking sector *Working Paper 01/2007* Research Department Market Research Division Hong Kong Monetary Authority Hong Kong P R China pp 1 – 20.
- 1053.** Wong E, Wong J, Leung Ph 2008 The foreign exchange exposure of Chinese banks *Working Paper 07/2008* Research Department Market Research Division Hong Kong Monetary Authority Hong Kong P R China pp 1 – 25.
- 1054.** Yu I-W, Fung L, Tam Ch-S 2007 Assessing financial market integration in Asia equity markets *Working Paper 04/2007* Research Department Market Research Division Hong Kong Monetary Authority Hong Kong P R China pp 1 – 37.
- 1055.** Acemoglu D, Rogoff K, Woodford M (editors) 2008 NBER macroeconomics annual 2008 *University of Chicago Press* Cambridge MA USA.
- 1056.** Baglioni A, Monticini A 2008 The intraday price of money: Evidence from the e-MID market *Journal of Money, Credit and Banking* **40** (7).
- 1057.** Barndorff-Nielsen O E, Hansen P R, Lunde A, Shephard N 2008 Realized kernels in practice: Trades and quotes *Econometrics Journal* **4** pp 1 – 33.
- 1058.** Bartram S M (January) 2008 What lies beneath: Foreign exchange rate exposure, hedging and cash flows *Department of Accounting and Finance Management School Lancaster University UK MPRA Paper no 6661* pp 1 – 31 <http://mpa.ub.uni-muenchen.de/6661/> .
- 1059.** Beaupain R, Durré A 2008 The inter-day and intra-day patterns of the overnight market: Evidence from an electronic platform *ECB Working Paper no 988*.
- 1060.** Berger D W, Chaboud A P, Chernenko S V, Howorka E, Wright J H 2008 Order flow and exchange rate dynamics in electronic brokerage system data *Journal of International Economics* **75** (1) pp 93 – 109.
- 1061.** Brunnermeier M K, Nagel S, Pedersen L H 2008 Carry trades and currency crashes *NBER Macroeconomics Annual 2008* NBER USA.
- 1062.** Burnside A C 2008 Comment on "Carry trades and currency crashes" in NBER chapters *NBER Macroeconomics Annual 2008* Acemoglu D, Rogoff K, Woodford M (editors) National Bureau of Economic Research Inc USA.
- 1063.** Burnside A, Eichenbaum M, Kleshchelski I, Rebelo S, Hall L, Hall H 2008 Do Peso problems explain the returns to the carry trade? *NBER Working Papers 14054* NBER USA.

- 1064.** Chinn M D, Moore M J 2008 Private information and the monetary model of exchange rates: Evidence from a novel data set <http://www.imf.org/External/NP/seminars/eng/2007/macrosfin/index.htm> .
- 1065.** Chinn M D, Moore M J 2011 Order flow and the monetary model of exchange rates: Evidence from a novel data set *Journal of Money, Credit and Banking* **43** (8) pp 1599 – 1624.
- 1066.** Gagnon J E, Chaboud A 2008 What Can the Data Tell Us About Carry Trades in Japanese Yen? *FRB International Finance Discussion Paper 899*.
- 1067.** Lam L, Fung L, Yu I-W 2008 Comparing forecast performance of exchange rate models *Working Paper 08/2008* Research Department Market Research Division Hong Kong Monetary Authority Hong Kong P R China pp 1 – 23.
- 1068.** Lien K 2008 Day trading and swing trading the currency market: Technical and fundamental strategies to profit from market moves *John Wiley and Sons* New York USA.
- 1069.** Lindley R 2008 Reducing foreign exchange settlement risk *BIS Quarterly Review* **3** pp 53 – 65.
- 1070.** Liu L-G, Tsang A 2008 Exchange rate pass-through to domestic inflation in Hong Kong *Working Paper 02/2008* Research Department Market Research Division Hong Kong Monetary Authority Hong Kong P R China pp 1 – 23.
- 1071.** Liu Q, Fung H-G, Tse Y 2008 An analysis of price linkages among DJIA index, futures, and exchange-traded fund markets *Review of Futures Markets*.
- 1072.** Lo I, Sapp S G 2008 The submission of limit orders or market orders: The role of timing and information in the Reuters D2000-2 system *Journal of International Money and Finance* **27** (7) pp 1056 – 1073.
- 1073.** Lo I, Sapp S G 2010 Order aggressiveness and quantity: How are they determined in a limit order market? *Journal of International Financial Markets, Institutions and Money* **20** (3) pp 213 – 237.
- 1074.** Ramadorai T 2008 What determines transaction costs in foreign exchange markets? *International Journal of Finance and Economics* **13** (1) pp 14 – 25.
- 1075.** Sebastião H M C V 2008 The partial adjustment factors of FTSE 100 stock index and stock index futures: The informational impact of electronic trading systems *Working Paper no 7* Faculdade de Economia da Universidade de Coimbra Portugal pp 1 – 48.
- 1076.** Terada T, Higashio N, Iwasaki J 2008 Recent trends in Japanese foreign-exchange margin trading *Bank of Japan Review no 2008-E-3* Tokyo Japan.

- 1077.** Adrian T, Etula E, Shin H S 2009 Risk appetite and exchange rates *Staff Report no 361* Reserve Bank of New York NY USA.
- 1078.** Bacchetta Ph, Mertens E, Van Wincoop E 2009 Predictability in financial markets: What do survey expectations tell us? *Journal of International Money and Finance* **28** (3) pp 406 – 426.
- 1079.** Baba N, Packer F 2009 From turmoil to crisis: Dislocations in the FX swap market before and after the failure of Lehman Brothers *BIS Working Papers* 285 Bank for International Settlements Basel Switzerland.
- 1080.** Brunnermeier M K, Nagel S, Pedersen L H 2009 Carry trades and currency crashes in NBER macroeconomics annual 2008 vol **23** Acemoglu D, Rogoff K, Woodford M (editors) *University of Chicago Press* Cambridge MA USA pp 313 – 347.
- 1081.** Brunnermeier M, Crockett A, Goodhart C, Persaud A D, Shin H 2009 The fundamental principles of financial regulation *Geneva Reports on the World Economy 11* Preliminary Conference Draft www.voxeu.org/reports/Geneva11.pdf .
- 1082.** Bubák V, Zikes F 2009 Distribution and dynamics of Central-European exchange rates: Evidence from intraday data *Czech Journal of Economics and Finance* **4** pp 334 – 359.
- 1083.** Bubák V, Kočenda E, Žikeš F 2010 Volatility transmission in emerging European foreign exchange markets *CESIFO Working Paper no 3063* pp 1 – 36.
- 1084.** De Zwart G, Markwat T, Swinkels L, van Dijk D 2009 The economic value of fundamental and technical information in emerging currency markets *Journal of International Money and Finance* **28** (4) pp 581 – 604.
- 1085.** Ding L 2009 Bid-ask spread and order size in the foreign exchange market: An empirical investigation *International Journal of Finance and Economics* **14** (1) pp 98 – 105.
- 1086.** Gallardo P, Heath A (March) 2009 Execution methods in foreign exchange markets *BIS Quarterly Review* pp 83 – 91.
- 1087.** Gençay R, Gradojevic N 2009 Informed trading in an electronic foreign exchange market *The Rimini Centre for Economic Analysis* Bologna University Italy pp 1 – 12.
- 1088.** Jiang Zh-Q, Zhou W-X 2009 De-trended fluctuation analysis of inter-trade durations *Physica A* **388** pp 433 – 440.
- 1089.** Hattori M, Shin H S 2009 Yen carry trade and the subprime crisis *IMF Staff Papers* IMF USA.
- 1090.** He D, Zhang Z, Wang H 2009 Hong Kong's financial market interactions with the US and mainland China in crisis and tranquil times *Working Paper 10/2009* Research

- Department Market Research Division Hong Kong Monetary Authority Hong Kong P R China pp 1 – 27.
- 1091.** Heath A, Whitelaw J June 2011 Electronic trading and the Australian foreign exchange market *Bulletin Reserve Bank of Australia Canberra Australia* pp 41 – 48.
- 1092.** McGuire P, von Peter G 2009 The US dollar shortage in global banking *BIS Quarterly Review (March 2009)* pp 47 – 63.
- 1093.** Meyers R A (editor) 2009 Encyclopedia of complexity and system science *Springer*.
- 1094.** Muller A, Verschoor W F 2009 The effect of exchange rate variability on US shareholder wealth *Journal of Banking & Finance* pp 1963 – 1972.
- 1095.** Nolte I, Nolte S 2009 Customer trading in the foreign exchange market. Empirical evidence from an Internet trading platform *Working Paper 09-01 FERC*.
- 1096.** Nolte I, Nolte S 2011 How do individual investors trade? *European Journal of Finance* pp 1 – 27.
- 1097.** Serban A F (November) 2009 Combining mean reversion and momentum trading strategies in foreign exchange markets *Department of Economics West Virginia University USA* pp 1 – 30.
- 1098.** Simwaka K, Mkandawire L 2009 The efficacy of foreign exchange market intervention in Malawi *Reserve Bank of Malawi MPRA Paper no 15946* pp 1 – 39
<http://mpra.ub.uni-muenchen.de/15946/> .
- 1099.** Breedon F, Vitale P 2010 An empirical study of portfolio-balance and information effects of order flow on exchange rates *Journal of International Money and Finance* **29** (3) pp 504 – 524.
- 1100.** Breedon F, Rime D, Vitale P 2011 Carry trades, order flow and the forward bias puzzle *Working Paper Norges Bank Oslo Norway*.
- 1101.** Dunne P, Hau H, Moore M 2010 International order flows: Explaining equity and exchange rate returns *Journal of International Money and Finance* **29** (2) pp 358 – 386.
- 1102.** Fukuda Sh-I, Kon Y (February) 2010 Macroeconomic impacts of foreign exchange reserve accumulation: Theory and international evidence *ADBI Working Paper Series no 197 Asian Development Bank Institute Tokyo Japan*
<http://www.adbi.org/working-paper/2010/02/19/3515.macroeconomic.impact.forex.reserve.accumulation/> .
- 1103.** Liu L-Zh, Qian X-Y, Lu H-Y 2010 Cross-sample entropy of foreign exchange time series *Physica A* **389** pp 4785 – 4792.

- 1104.** Maurer K-O, Schäfer C 2010 Analysis of binary trading patterns in Xetra *CFS Working Paper no 2010/12* Center for Financial Studies an der Johann Wolfgang Goethe-Universität Frankfurt am Main Leibniz Information Centre for Economics Germany pp 1 – 22.
- 1105.** Nightingale S, Ossolinski C, Zurawski A December 2010 Activity in global foreign exchange markets *RBA Bulletin* pp 45 – 51.
- 1106.** Pasquariello P 2010 Central bank intervention and the intraday process of price formation in the currency markets *Journal of International Money and Finance* **29** (6) pp 1045 – 1061.
- 1107.** Yiu M S, Ho W-Y A, Ma Y, Tsang Sh-K 2010 An analytical framework for the Hong Kong dollar exchange rate dynamics under strong capital inflows *Working Paper 05/2010* Hong Kong Monetary Authority Hong Kong P R China.
- 1108.** Diamond R (April 4) 2011 Banks' profits could take hit in fight over forex fees *Pensions and Investments*.
- 1109.** Durčáková J 2011 Foreign exchange rate regimes and foreign exchange markets in transitive economies *Prague Economic Papers* **4** pp Prague Check Republic pp 309 – 328.
- 1110.** Heimer R Z, Simon D 2011 Facebook finance: How social interaction propagates active investing *Working Paper* Brandeis University.
- 1111.** Marzo M, Zagaglia P P 2011 Trading directions and the pricing of euro interbank deposits in the long run *Working Paper 11-20* The Rimini Centre for Economic Analysis University of Bologna Italy.
- 1112.** Moore M J, Payne R 2011 On the sources of private information in FX markets *Journal of Banking and Finance* **35** (5) pp 1250 – 1262.
- 1113.** Plantin G, Shin H H 2011 Carry trades, monetary policy and speculative dynamics *Princeton University* USA.
- 1114.** Rafferty B 2011 Currency returns, skewness and crash risk *Working Paper* Duke University North Carolina Durham USA.
- 1115.** Wang Y, Wu Ch, Pan Zh 2011 Multifractal de-trending moving average analysis on the US dollar exchange rates *Physica A* **390** pp 3512 – 3523.
- 1116.** Banti Ch, Phylaktis K, Sarno L 2012 Global liquidity risk in the foreign exchange market *Journal of International Money and Finance* **31** (2) pp 267 – 291.
- 1117.** James J, Marsh I W, Sarno L (editors) 2012 The handbook of exchange rates *John Wiley & Sons Inc* USA.
- 1118.** Ledenyov V O, Ledenyov D O 2012a Shaping the international financial system in century of globalization *Cornell University* NY USA www.arxiv.org/1206.2022.pdf pp 1 – 20.

- 1119.** Ledenyov V O, Ledenyov D O 2012b Designing the new architecture of international financial system in era of great changes by globalization *Cornell University* NY USA [www.arxiv.org/1206.2778.pdf](http://www.arxiv.org/abs/1206.2778) pp 1 – 18.
- 1120.** Ledenyov D O, Ledenyov V O 2012a On the new central bank strategy toward monetary and financial instabilities management in finances: econophysical analysis of nonlinear dynamical financial systems *Cornell University* NY USA [www.arxiv.org/1211.1897.pdf](http://www.arxiv.org/abs/1211.1897) pp 1 – 8.
- 1121.** Ledenyov D O, Ledenyov V O 2012b On the risk management with application of econophysics analysis in central banks and financial institutions *Cornell University* NY USA [www.arxiv.org/1211.4108.pdf](http://www.arxiv.org/abs/1211.4108) pp 1 – 10.
- 1122.** Ledenyov D O, Ledenyov V O 2012c Nonlinearities in microwave superconductivity *Cornell University* NY USA [www.arxiv.org/1206.4426.pdf](http://www.arxiv.org/abs/1206.4426) pp 1 – 919.
- 1123.** Ledenyov V O, Ledenyov D O, Ledenyov O P 2012 Features of oxygen and its vacancies diffusion in $\text{YBa}_2\text{Cu}_3\text{O}_{7-\delta}$ thin films near to magnetic quantum lines *Cornell University* NY USA [www.arxiv.org/1206.5635v1.pdf](http://www.arxiv.org/abs/1206.5635v1) pp 1 – 7.
- 1124.** Ledenyov D O, Ledenyov V O 2013a On the optimal allocation of assets in investment portfolio with application of modern portfolio management and nonlinear dynamic chaos theories in investment, commercial and central banks *Cornell University* NY USA [www.arxiv.org/1301.4881.pdf](http://www.arxiv.org/abs/1301.4881) pp 1 – 34.
- 1125.** Ledenyov D O, Ledenyov V O 2013b On the theory of firm in nonlinear dynamic financial and economic systems *Cornell University* NY USA [www.arxiv.org/1206.4426v2.pdf](http://www.arxiv.org/abs/1206.4426v2) pp 1 – 27.
- 1126.** Ledenyov D O, Ledenyov V O 2013c On the accurate characterization of business cycles in nonlinear dynamic financial and economic systems *Cornell University* NY USA [www.arxiv.org/1304.4807.pdf](http://www.arxiv.org/abs/1304.4807) pp 1 – 26.
- 1127.** Ledenyov D O, Ledenyov V O 2013d To the problem of turbulence in quantitative easing transmission channels and transactions network channels at quantitative easing policy implementation by central banks *Cornell University* NY USA [www.arxiv.org/1305.5656.pdf](http://www.arxiv.org/abs/1305.5656) pp 1 – 40.
- 1128.** Ledenyov D O, Ledenyov V O 2013e To the problem of evaluation of market risk of global equity index portfolio in global capital markets *MPRA Paper no 47708* Munich University Munich Germany pp 1 – 25 <http://mpra.ub.uni-muenchen.de/47708/> .
- 1129.** Ledenyov D O, Ledenyov V O 2013f Some thoughts on accurate characterization of stock market indexes trends in conditions of nonlinear capital flows during electronic trading

- at stock exchanges in global capital markets *MPRA Paper no 49964* Munich University Munich Germany pp 1 – 52 <http://mpra.ub.uni-muenchen.de/49964/> .
- 1130.** Ledenyov D O, Ledenyov V O 2013g On the Stratonovich - Kalman - Bucy filtering algorithm application for accurate characterization of financial time series with use of state-space model by central banks *MPRA Paper no 50235* Munich University Munich Germany pp 1 – 52 <http://mpra.ub.uni-muenchen.de/50235/> .
- 1131.** Ledenyov D O, Ledenyov V O 2013h Tracking and replication of hedge fund optimal investment portfolio strategies in global capital markets in presence of nonlinearities *MPRA Paper no 51176* Munich University Munich Germany pp 1 – 92 <http://mpra.ub.uni-muenchen.de/51176/> .
- 1132.** Ledenyov D O, Ledenyov V O 2013i Venture capital optimal investment portfolio strategies selection in diffusion - type financial systems in global capital markets with nonlinearities *MPRA Paper no 51903* Munich University Munich Germany pp 1 – 81 <http://mpra.ub.uni-muenchen.de/51903/> .
- 1133.** Ledenyov D O, Ledenyov V O 2014a Mergers and acquisitions transactions strategies in diffusion - type financial systems in highly volatile global capital markets with nonlinearities *MPRA Paper no 53906* Munich University Munich Germany pp 1 – 142 <http://mpra.ub.uni-muenchen.de/53906/> .
- 1134.** Ledenyov D O, Ledenyov V O 2014b Strategies on initial public offering of company equity at stock exchanges in imperfect highly volatile global capital markets with induced nonlinearities *MPRA Paper no 53780* Munich University Munich Germany pp 1 – 139 <http://mpra.ub.uni-muenchen.de/53780/> .
- 1135.** Ledenyov D O, Ledenyov V O (2014c) *MicroFX* foreign currencies trading software platform with embedded optimized Stratonovich – Kalman - Bucy filtering algorithm, particle filtering algorithm, macroeconomic analysis algorithm, market microstructure analysis algorithm, order flow analysis algorithm, comparative analysis algorithm *ECE James Cook University* Townsville Australia, Kharkov Ukraine.
- 1136.** Mancini L, Rinaldo A, Wrampelmeyer J 2012 Liquidity in the foreign exchange market: Measurement, commonality, and risk premiums *Journal of Finance*.
- 1137.** Sheng A (February) 2012a Hong Kong's global challenge - How to build on success pp 1 – 3 <http://www.funglobalinstitute.org/en/hong-kong's-global-challenge-how-build-success> , <http://www.funglobalinstitute.org/en/experts/andrew-sheng> .

- 1138.** Sheng A (August) 2012b The future of central banking *Fung Global Institute Hong Kong P R China, Central Banking Publications London UK*
<http://riskbooks.com/the-future-of-central-banking> ,
<http://www.fungglobalinstitute.org/en/future-central-banking> ,
<http://www.fungglobalinstitute.org/en/experts/andrew-sheng> .
- 1139.** Sheng A (April) 2014 Invited speech *6th London School of Economics Asia Forum 2014 Kuala Lumpur Malaysia*
http://media.rawvoice.com/lse_publiclecturesandevents/richmedia.lse.ac.uk/publiclecturesandevents/20140403_1540_plenary4.mp4 .
- 1140.** Trencă I, Plesoianu A, Căpușan R 2012 Multifractal structure of Central and Eastern European foreign exchange markets *Faculty of Economics and Business Administration Babes-Bolyai University, Faculty of Finance, Insurance, Banking and Stock Exchange Academy of Economic Studies* pp 784 – 790.
- 1141.** Wang D-H, Yu X-W, Suo Y-Y 2012 Statistical properties of the Yuan exchange rate index *Physica A* **391** pp 3503 – 3512.
- 1142.** Lassmann A 2013 Exchange rate transmission and export activity at the firm level *Working Paper 331 KOF Swiss Economic Institute Swiss Federal Institute of Technology Zurich Switzerland* pp 1 – 39 www.kof.ethz.ch .
- 1143.** Ingves St, Danielsson J, Goodhart Ch (July 7) 2014 Towards a safer and more stable financial system: Stefan Ingves *London School of Economics and Political Science London UK*
http://media.rawvoice.com/lse_publiclecturesandevents/richmedia.lse.ac.uk/publiclecturesandevents/20140707_1830_saferStableFinancial.mp4 .
- Probability Theory, Statistics Theory, Brownian Movement Theory, Diffusion Theory and Chaos Theory in Econometrics and Econophysics:***
- 1144.** Huygens 1657 De ratiociniis in aleae ludo (On calculations in games of chance).
- 1145.** Bernoulli J 1713 Ars conjectandi (The art of guessing).
- 1146.** Bernoulli D 1738, 1954 Specimen theoriae novae de mensura sortis *Commentarii Academiae Scientiarum Imperialis Petropolitanae Petropoli* vol **5** pp 175 – 192; Exposition of a new theory on the measurements of risk Sommer L (translator) *Econometrica* vol **22** pp 23 – 36.
- 1147.** De Moivre 1730 Miscellanea analytica supplementum (The analytic method).
- 1148.** De Laplace 1812 Théorie analytique des probabilités *Paris France*.

- 1149.** Bunyakovsky V Ya 1825 Heat propagation in solids *Ph D Thesis* under Prof. Augustin -Louis Cauchy supervision *École Polytechnique* Paris France.
- 1150.** Bunyakovsky V Ya 1846 Foundations of the mathematical theory of probability *St. Petersburg* Russian Federation.
- 1151.** Connor J J, Robertson E F (July) 2000 Viktor Yakovlevich Bunyakovsky (December 16, 1804 - December 12, 1889) *School of Mathematics and Statistics* University of St Andrews Scotland UK
<http://www-history.mcs.st-andrews.ac.uk/Biographies/Bunyakovsky.html> .
- 1152.** V Ya Bunyakovsky *International Conference* (August 20 - 21) 2004 Private communications with conference participants on V Ya Bunyakovsky's mathematical theory of probability and its applications in econophysics and econometrics during tour to Town of Bar Vinnytsia Region Ukraine *V Ya Bunyakovsky International Conference Institute of Mathematics of National Academy of Sciences of Ukraine (NASU)* Kyiv Ukraine www.imath.kiev.ua/~syta/bunyak .
- 1153.** Chebyshev P L 1846 An experience in the elementary analysis of the probability theory *Crelle's Journal fur die Reine und Angewandte Mathematik*.
- 1154.** Chebyshev P L 1867 Des valeurs moyennes *Journal de Math'ematics Pures et Appliqu'ees* vol **12** pp 177 – 184.
- 1155.** Chebyshev P L 1891 Sur deux theoremes relatifs aux probabilités *Acta Mathematica* vol **14**.
- 1156.** Chebyshev P L 1936 Theory of probability: Lectures given in 1879 and 1880 Lyapunov A N (lecture notes writer) Krylov A N (editor) *Moscow - St Petersburg* Russian Federation.
- 1157.** Markov A A 1890 On one problem by D I Mendeleev *Zapiski Imperatorskoi Akademii Nauk SPb* **62** pp 1 – 24.
- 1158.** Markov A A 1899 Application des fonctions continues au calcul des probabilités *Kazan Bulletin* **9** (2) pp 29 – 34 Russian Federation.
- 1159.** Markov A A 1900, 1912, 1913 Calculation of probabilities *St Petersburg* Russian Federation; *Wahrscheinlichkeits-Rechnung Teubner* Leipzig-Berlin Germany; 3rd edition *St Petersburg* Russian Federation.
- 1160.** Markov A A 1906 Extension of law of big numbers on variables, depending from each other *Izvestiya Fiziko-Matematicheskogo Obschestva pri Kazanskom Universitete* 2nd series vol **15** (94) pp 135 – 156 Russian Federation.

- 1161.** Markov A A 1907, 1910 Research on fine case of depending trials *Izvestiya Akademii Nauk SPb* 6th series vol **1** (93) pp 61 – 80; Recherches sur un cas remarquable d'épreuves dependantes *Acta Mathematica* **33** pp 87 – 104 Stockholm Sweden.
- 1162.** Markov A A 1908, 1912, 1971 Extension of limit theorems of calculation of probabilities to sum of variables, connected in chain *Zapiski Akademii Nauk po Fiziko-Matematicheskomu Otdeleniyu* 8th series vol **25** (3); Ausdehnung der Satze uber die Grenzwerte in der Wahrscheinlichkeitsrechnung auf eine Summe verketteter Grossen Liebmann H (translator) in *Wahrscheinlichkeitsrechnung* Markov A A (author) pp 272 – 298 *Teubner B G* Leipzig Germany; Extension of the limit theorems of probability theory to a sum of variables connected in a chain Petelin S (translator) in *Dynamic probabilities systems* Howard R A (editor) vol **1** pp 552 – 576 *John Wiley and Sons Inc* New York USA.
- 1163.** Markov A A 1910 Research on common case of trials, connected in chain *Zapiski Akademii Nauk po Fiziko-Matematicheskomu Otdeleniyu* 8th series vol **25** (93) Russian Federation.
- 1164.** Markov A A 1911 On one case of trials, connected in complex chain *Izvestiya Akademii Nauk SPb* 6th series vol **5** (93) pp 171 – 186 Russian Federation.
- 1165.** Markov A A 1912 On trials of connected in chain unobserved events *Izvestiya Akademii Nauk SPb* 6th series vol **6** (98) pp 551 – 572 Russian Federation.
- 1166.** Markov A A 1913 Example of statistical research on text of “Eugene Onegin”, illustrating interconnection of trials in chain *Izvestiya Akademii Nauk SPb* 6th series vol **7** (93) pp 153 – 162 Russian Federation.
- 1167.** Fisher I 1892 Mathematical investigations in the theory of value and prices *Transactions of the Connecticut Academy* **9** pp 1 – 124.
- 1168.** Einstein A 1905 On the movement of small particles suspended in a stationary liquid demanded by the molecular-kinetic theory of heat *Annalen der Physik* **17** pp 549 – 560.
- 1169.** Einstein A 1956 Investigation on the theory of the Brownian motion Furth R (editor) *Dover* New York USA.
- 1170.** Einstein A, Smolukhovsky M 1936 Brownian movement: Collection of research papers *ONTI* Moscow Russian Federation.
- 1171.** Bowley A L 1924 The mathematical groundwork of economic *Clarendon Press* Oxford UK.
- 1172.** Kolmogorov A N 1937 Markov chains with countable many states *Bulletin Moscow University* **1**.

- 1173.** Kolmogorov A N 1938 On analytic methods in probability theory *in* Selected works of Kolmogorov A N vol **2** Probability theory and mathematical statistics Shiryaev A N (editor) Springer Germany.
- 1174.** Kolmogorov A N 1947 The contribution of Russian science to the development of probability theory *Uchenye Zapiski Moskovskogo Universiteta* no 91.
- 1175.** Kolmogorov A N 1956 Probability theory in Mathematics: Its contents, methods, and meaning *Academy of Sciences USSR* vol **2**.
- 1176.** Kolmogorov A N 1956 Foundations of the theory of probability *Chelsea* New York USA.
- 1177.** Kolmogorov A N 1985 Mathematics and mechanics Selected works vol **1** *Nauka Publishing House* Moscow Russian Federation.
- 1178.** Kolmogorov A N 1986 Probability theory and mathematical statistics Selected works vol **2** *Nauka Publishing House* Moscow Russian Federation.
- 1179.** Allen R G D 1938 Mathematical analysis for economists *Macmillan* London UK.
- 1180.** Cramer H 1940 On the theory of stationary random processes *Ann Math* vol **41** pp 215 – 230.
- 1181.** Cramer H 1946 Mathematical methods of statistics *Princeton University Press* USA.
- 1182.** Cramer H, Leadbetter M 1967 Stationary and related stochastic processes. Sample function properties and their applications *John Wiley and Sons Inc* NY USA.
- 1183.** Bemshtein S N 1946 Theory of probability 4th edition *Gostehizdat* Moscow Russian Federation.
- 1184.** Hannan E J 1960 Time series analysis *Methuen* London.
- 1185.** Hannan E J 1970 Multiple time series *John Wiley and Sons Inc* New York USA.
- 1186.** Mandelbrot B B 1960 The Pareto-Levy law and the distribution of income *International Economic Review* no 1.
- 1187.** Mandelbrot B B 1963a The stable Paretian income distribution when the apparent exponent is near two *International Economic Review* no 4.
- 1188.** Mandelbrot B B 1963b The variation of certain speculative prices *Journal of Business* vol **36** pp 394 – 419.
- 1189.** Mandelbrot B B 1965 Une classe de processus stochastiques homothetiques a soi: Application a la loi climatologique de H. E. Hurst *Comptes Rendus de l'Academie des Sciences* vol **240** pp 3274 – 3277 Paris France.
- 1190.** Mandelbrot B B 1967a The variation of some other speculative prices *Journal of Business* vol **40** pp 393 – 413.

- 1191.** Mandelbrot B B (April) 1967b Some noises with $1/f$ spectrum: A bridge between direct current and white noise *IEEE Transactions on Information Theory* USA.
- 1192.** Mandelbrot B B, Taylor H M 1967 On the distribution of stock price difference *Operations Research* vol **15** no 6 pp 1057 – 1062.
- 1193.** Mandelbrot B B, van Ness J W 1968 Fractional Brownian motions, fractional noises and applications *SIAM Review* vol **10** no 4 pp 422 – 437.
- 1194.** Mandelbrot B B 1969 Robustness of the rescaled range R/S in the measurement of non-cyclic long-run statistical dependence *Water Resources Research* vol **5** no 5 pp 967 – 988.
- 1195.** Mandelbrot B B, Wallis J R 1969 Computer experiments with fractional Gaussian noises I, II, III *Water Resources Research* vol **5** pp 228 – 267.
- 1196.** Mandelbrot B B 1971 When can price be arbitrated efficiently? A limit of the validity of the random walk and martingale models *Review of Economics and Statistics* vol **53** pp 225 – 236.
- 1197.** Mandelbrot B B 1972 Statistical methodology for non-periodic cycles: From the covariance to R/S analysis *Annals of Economic and Social Measurement* vol **1** no 3 pp 259 – 290.
- 1198.** Mandelbrot B B 1975a Les objets fractals *Flammarion* Paris France.
- 1199.** Mandelbrot B B 1975b Limit theorems on the self-normalized range for weakly and strongly dependent process *Zeitschrift Wahrscheinlichkeitstheorie und Verwandte Gebiete* vol **31** pp 271 – 285.
- 1200.** Mandelbrot B B 1977 Fractals: Form, chance and dimension *W H Freeman* San Francisco USA.
- 1201.** Mandelbrot B B 1982 The fractal geometry of nature *W H Freeman* San Francisco USA.
- 1202.** Mandelbrot B B 1997 Fractals and scaling in finance *Springer* New York USA.
- 1203.** Gnedenko B V, Khinchin A Ya 1961 An elementary introduction to the theory of probability *Freeman* San Francisco USA.
- 1204.** Gnedenko B V 1988 The theory of probability *Mir* Moscow Russian Federation.
- 1205.** Abramowitz M, Stegun I A (editors) 1964 Handbook of mathematical functions *National Bureau of Standards Applied Mathematics Series* vol **55** USA.
- 1206.** Kubilius J 1964 Probabilistic methods in the theory of numbers *American Mathematical Society* Providence USA.
- 1207.** Akhiezer N I, Glazman I M 1966 Theory of linear operators in Hilbert space *Nauka* Moscow Russian Federation.

- 1208.** Lamperti J 1966 Probability *Benjamin* New York USA.
- 1209.** Kai-Lai Chung 1967 Markov chains with stationary transition probabilities *Springer-Verlag* New York USA.
- 1210.** Skorohod A V 1967 Random processes with independent increments *Nauka* Moscow Russian Federation.
- 1211.** Gikhman I I, Skorohod A V 1968 Stochastic differential equations *Naukova Dumka* Kiev Ukraine.
- 1212.** Gikhman I I, Skorohod A V 1969 Introduction to the theory of random processes 1st edition *Saunders* Philadelphia USA.
- 1213.** Gikhman I I, Skorohod A V 1974-1979 Theory of stochastic processes vols **1, 2, 3** *Springer-Verlag* New York-Berlin USA-Germany.
- 1214.** Breiman L 1968 Probability *Addison-Wesley* Reading MA USA.
- 1215.** Feller W 1968 An introduction to probability theory and its applications vols **1, 2** 3rd edition *John Wiley and Sons Inc* New York USA.
- 1216.** Brush S G 1968, 1977 A history of random processes: 1. Brownian movement *in* Study history statistics and probability Kendall M G, Plackett R L (editors) **2** pp 347 – 382 London UK.
- 1217.** Glesjer H 1969 A new test for heteroskedasticity *Journal of the American Statistical Association* **64** pp 316 – 323.
- 1218.** Ash R B 1970 Basic probability theory *John Wiley and Sons Inc* New York USA.
- 1219.** Ash R B 1972 Real analysis and probability *Academic Press* New York USA.
- 1220.** Ash R B, Gardner M F 1975 Topics in stochastic processes *Academic Press* New York USA.
- 1221.** Box G E P, Jenkins G M 1970 Time series analysis: Forecasting and control *Holden Day* San Francisco California USA.
- 1222.** Renyi A 1970 Probability theory *North-Holland Publishing Company* Amsterdam The Netherlands.
- 1223.** Isihara A 1971 Statistical physics *Academic Press* New York USA.
- 1224.** Borovkov A A 1976 Wahrscheinlichkeitstheorie: Eine EinjUhrung 1st edition *Birkhiuser* Basel-Stuttgart Switzerland-Germany.
- 1225.** Grangel C W J, Newbold P 1977 Forecasting economic time series *Academic Press* New York USA.

- 1226.** Pugachev V S 1979b Theory of probability and mathematical statistics 1st edition *Nauka* Moscow Russian Federation, 2nd edition *Fizmatlit* Moscow Russian Federation ISBN 5–92210254–0 pp 1 – 496.
- 1227.** Grangel C W J, Teräsvirta T 1993 Modeling nonlinear economic relationships *Oxford University Press* Oxford New York UK USA.
- 1228.** Karlin S, Taylor H M 1981 A second course in stochastic processes *Academic Press* New York USA.
- 1229.** Venttsel A D 1981 A course in the theory of stochastic processes *McGraw-Hill* New York USA.
- 1230.** Yaglom A M, Yaglom I M 1983 Probability and information *Reidel Dordrecht*.
- 1231.** Pagan A 1984 Econometric issues in the analysis of regressions with generated regressors *International Economic Review* **25** pp 221 – 247.
- 1232.** Van Horne J C 1984 Financial market rates and flows *Prentice Hall* Englewood Cliffs NJ USA.
- 1233.** Taylor S 1986 Modeling financial time series *John Willey and Sons Inc* New York USA.
- 1234.** Tong H 1986 Nonlinear time series *Oxford University Press* Oxford UK.
- 1235.** Sharkovsky A N, Maistrenko Yu L, Romanenko E Yu 1986 Differential equations and their applications *Naukova Dumka* Kiev Ukraine pp 1 – 280.
- 1236.** Newey W, West K 1987 A simple positive semi-definite, heteroskedasticity and autocorrelation consistent covariance matrix *Econometrica* **55** pp 703 – 708.
- 1237.** Luukkonen R, Saikkonen P, Terasvirta T 1988 Testing linearity against smooth transition autoregressive models *Biometrika* **75** pp 491 – 499.
- 1238.** Judge G, Hill C, Griffiths W, Lee T, Lutkepol H 1988 An introduction to the theory and practice of econometrics *John Wiley and Sons Inc* New York USA.
- 1239.** Hardle W 1990 Applied nonparametric regression *Econometric Society Monograph Cambridge University Press* Cambridge UK.
- 1240.** Tong H 1990 Nonlinear time series: A dynamical system approach *Clarendon Press* Oxford UK.
- 1241.** Johansen S 1992 Cointegration in partial systems and the efficiency of single equation analysis *Journal of Econometrics* **52** pp 389 – 402.
- 1242.** Pesaran M H, Potter S M (editors) 1993 Nonlinear dynamics, chaos and econometrics *John Willey and Sons Inc* New York USA.
- 1243.** Banerjee A, Dolado J J, Galbraith J W, Hendry D F 1993 Cointegration, error correction, and the econometric analysis of nonstationary data *Oxford University Press* Oxford UK.

- 1244.** Hamilton J D 1994 Time series analysis *Princeton University Press* Princeton, NJ USA.
- 1245.** Peters E E 1994 Fractal market analysis: Applying chaos theory to investment and economics *John Wiley and Sons Inc* New York USA.
- 1246.** Enders W 1995 Applied econometric time series *John Wiley and Sons Inc* New York USA.
- 1247.** Johansen S 1995 Likelihood based inference in co-integrated vector autoregressive models *Oxford University Press* Oxford UK.
- 1248.** Karatzas I, Shreve S 1995 Methods of mathematical finance *Columbia University Press* New York USA.
- 1249.** Moore G E 1995 Lithography and the future of Moore's law *Proceedings SPIE Symposium Optical Microlithography Conference VIII* **2440** 2.
- 1250.** Shiryaev A N 1995 Probability 2nd edition *Springer - Verlag* ISBN 0-387-94549-0 New York USA pp 1 – 621.
- 1251.** Moore G E 2003 No exponential is forever – but we can delay forever *ISSCC*.
- 1252.** Campbell J Y, Lo A W, MacKinlay A C 1996 The econometrics of financial markets *Princeton University Press* Princeton USA.
- 1253.** Mosekilde E 1996 Topics in nonlinear dynamics: Applications to physics, biology and economic systems *World Scientific Publishing Pte Ltd* Singapore.
- 1254.** Rogers L C G, Talay D (editors) 1997 Numerical methods in finance *Cambridge University Press* Cambridge UK.
- 1255.** Campbell J, Lo A, MacKinlay C 1997 The econometrics of financial markets *Princeton University Press* Princeton NJ USA.
- 1256.** Greene W H 1997, 2003 Econometric analysis 1st edition, 5th edition *Prentice Hall* Upper Saddle River USA.
- 1257.** Hasem P M, Pesaran B 1997 Working with Microfit 4.0: Interactive econometric analysis *Oxford University Press* Oxford UK.
- 1258.** Lo A W, MacKinlay A C 1997 The econometrics of financial markets *Princeton University Press* Princeton New Jersey USA.
- 1259.** Anderson H M, Vahid F 1998 Testing multiple equation systems for common nonlinear factors *Journal of Econometrics* **84** pp 1 – 37.
- 1260.** Escribano, Jorda 1999 Improved testing and specification of smooth transition regression models in Nonlinear time series analysis of economic and financial data Rothman (editor) *Kluwer Academic Press* Amsterdam The Netherlands.

1261. Hasem P M, Shin Y 1999 An autoregressive distributed lag modelling approach to cointegration analysis *in* Econometrics and economic theory in the 20th century: The Ranger Frisch centennial symposium Strom S, Holly A, Diamond P (editors) *Cambridge University Press* Cambridge UK www.econ.cam.ac.uk/faculty/pesaran/ADL.pdf .
1262. Hasem P M, Shin Y, Smith R J 2001 Bounds testing approaches to the analysis of level relationships *Journal of Applied Econometrics* **16** (3) pp 289 – 326.
1263. Potter S 1999 Non-linear time series modelling: An introduction *Typescript* Federal Reserve Bank of New York NY USA.
1264. Rothman (editor) 1999 Nonlinear time series analysis of economic and financial data *Kluwer Academic Press* Amsterdam The Netherlands.
1265. Hayashi F 2000 Econometrics *Princeton University Press* Princeton NJ USA.
1266. Durbin J, Koopman S J 2000 Time series analysis of non-Gaussian observations based on state-space models from both classical and Bayesian perspectives *Journal of Royal Statistical Society Series B* **62** pp 3 – 56.
1267. Durbin J, Koopman S J 2002 A simple and efficient simulation smoother for state space time series analysis *Biometrika* **89** pp 603 – 615.
1268. Durbin J, Koopman S J 2012 Time series analysis by state space methods 2nd edition *Oxford University Press* Oxford UK.
1269. Ilinski K 2001 Physics of finance: Gauge modelling in non-equilibrium pricing *John Wiley and Sons Inc* New York USA ISBN-10: 0471877387 pp 1 – 300.
1270. Nicolau J 2002 Stationary processes that look like random walks – The bounded random walk process in discrete and continuous time *Econometric Theory* **18** pp 99 – 118.
1271. Koop G 2003 Bayesian econometrics *John Wiley and Sons Inc* New York USA.
1272. Ledenyov V O, Ledenyov O P, Ledenyov D O 2002 A quantum random number generator on magnetic flux qubits *Proceedings of the 2nd Institute of Electrical and Electronics Engineers Conference IEEE-NANO 2002* Chicago Washington DC USA IEEE Catalog no 02TH86302002 Library of Congress number: 2002106799 ISBN: 0-7803-7538-6.
1273. Davidson R, MacKinnon J 2004 Econometric theory and methods *Oxford University Press* Oxford UK.
1274. Protter P E 2005 Stochastic integration and differential equations *Springer* Germany.
Wiener Filtering Theory, Pugachev Filtering Theory, Stratanovich Optimal Nonlinear Filtering Theory, Stratanovich-Kalman-Bucy Filtering Algorithm, Stratanovich-Kalman-Bucy Filter, Particle Filter in Econometrics, Econophysics, Electrical and Computer Engineering:

- 1275.** Edgeworth F I 1905 The law of error *Proceedings Cambridge Philosophic Society* vol **20** pp 36 – 65.
- 1276.** Wiener N 1923 Differential space *Journal of Mathematical Physics Math Inst Tech* vol **2** pp 131 – 174.
- 1277.** Wiener N 1930 Generalized harmonic analysis *Acta Math* vol **55** no 2 - 3 pp 117 – 258.
- 1278.** Wiener N 1949 The extrapolation, interpolation and smoothing of stationary time series *John Wiley & Sons Inc* New York NY USA.
- 1279.** Andronov A A, Vitt A A, Pontryagin L S 1933 On statistical consideration of dynamic systems *Soviet Journal of Experimental and Theoretical Physics* vol **3** no 3 pp 165 – 180.
- 1280.** Ito K 1944 Stochastic integral *Proceedings Imperial Academy Tokyo* vol **20** pp 519 – 524.
- 1281.** Ito K 1951a On a formula concerning stochastic differentials *Nagoya Mathematics Journal* vol **3** pp 55 – 65.
- 1282.** Ito K 1951b On stochastic differential equations *Mem American Mathematical Society* vol **4** pp 1 – 51.
- 1283.** Ito K, Xiong K 2000 Gaussian filters for nonlinear filtering problems *IEEE Transactions on Automatic Control* vol **45** no 5.
- 1284.** Pugachev V S 1944 Random functions, defined by common differential equations *Works by Air Forces Military Academy named after Zhukovsky N E* vol **118** pp 3 – 36.
- 1285.** Pugachev V S 1956a The use of canonical expansions of random functions in determining an optimum linear system *Automatics and Remote Control (USSR)* vol **17** pp 489 – 499.
- 1286.** Pugachev V S 1956b On a possible general solution of the problem of determining optimum dynamic systems *Automatics and Remote Control (USSR)* vol **17** pp 585 – 589.
- 1287.** Pugachev V S 1960 Theory of random functions and its application in problems of automatic control *State Publishing House of Physical Mathematical Literature (Fizmatlit)* Moscow Russian Federation pp 1 – 883.
- 1288.** Pugachev V S 1961 Application of theory of Markov processes in analysis of accuracy of automatic systems *News Academy of Sciences USSR Energetics and Automatics* no 3 pp 46 – 57.
- 1289.** Pugachev V S 1962 Theory of random functions and its application to problems of automatic control *Fizmatgiz* Moscow Russian Federation.
- 1290.** Pugachev V S 1971 On distribution of computing number of random process *Works of Ist All Union Symposium on Statistics Problems in Technical Cybernetics* Moscow USSR

- February 14 - 18, 1967 in *Nonlinear and optimal systems Nauka Moscow Russian Federation* pp 374 – 381.
- 1291.** Pugachev V S 1973, 1974, 1975 *Stochastic systems Nauka Moscow Russian Federation* issues 7-9, 11-12, 10.
- 1292.** Pugachev V S (editor) 1974 *Foundations of automatic control Nauka Moscow Russian Federation*.
- 1293.** Pugachev V S 1978 *Estimation of variables and parameters in stochastic systems, described by differential equations DAN USSR* vol **241** no 5 pp 1031 – 1034.
- 1294.** Pugachev V S 1979a *Estimation of state and parameters of continuous nonlinear systems Automatics and Tele-mechanics* no 6 pp 63 – 79.
- 1295.** Pugachev V S 1979b *Theory of probability and mathematical statistics* 1st edition *Nauka Moscow Russian Federation*, 2nd edition *Fizmatlit Moscow Russian Federation* ISBN 5–92210254–0 pp 1 – 496.
- 1296.** Pugachev V S 1980a *Estimation of Markov processes. Time series Proceedings International Conference Nottingham March, 1979; North Holland Publishing House Amsterdam New York London* pp 389 – 400.
- 1297.** Pugachev V S 1980b *Finite distributions of processes, defined by stochastic differential equations, and extrapolation of these processes DAN USSR* vol **251** no 1 pp 40 – 43.
- 1298.** Pugachev V S 1981 *The finite-dimensional distributions of a random process determined by a stochastic differential equation and their application to control problems Problems of Control and Theory of Information* vol **10** no 2 pp 95 – 114.
- 1299.** Pugachev V S 1982a *Generalization of theory of conditional estimation and extrapolation DAN USSR* vol **262** no 3 pp 535 - 538.
- 1300.** Pugachev V S 1982b *Conditionally optimal estimation in stochastic differential systems Automatics* vol **118** no 6 pp 685 – 696.
- 1301.** Pugachev V S 1984 *Conditionally optimal filtering and extrapolation of continuous processes Automatics and Tele-mechanics* no 2 pp 82 – 89.
- 1302.** Pugachev V S 1985 *Conditionally optimal estimation in systems with randomly varying structure Proceedings of the 9th World Congress of IFAC Budapest Hungary July 2-6, 1984* vol **2** pp 773 – 777 *Pergamon Press Oxford UK*.
- 1303.** Pugachev V S 1986 *Approximate methods for findings finite-dimensional distributions of random sequences determined by difference equations Problems of Control and Theory of Information* vol **15** no 2 pp 101 – 109.

- 1304.** Pugachev V S, Sinitsyn I N 1986 Directions of development of mathematical support for stochastic systems research in Modern informatics techniques *Nauka* Moscow Russian Federation pp 166 – 174.
- 1305.** Pugachev V S, Sinitsyn I N, Shin V I 1986a Conditionally optimal discrete filtering of processes in continuous - discrete systems *DAN USSR* vol **289** no 2 pp 297 - 301.
- 1306.** Pugachev V S, Sinitsyn I N, Shin V I 1986b Problems of analysis and on-line conditionally optimal filtering of processes in nonlinear stochastic systems *Preprints of the 2nd IFAC Symposium on Stochastic Control Vilnius USSR* May 19-23, 1986 no 1 pp 4 – 18.
- 1307.** Pugachev V S, Sinitsyn I N, Shin V I 1987a On one program realization of method of normal approximation in problems of analysis of nonlinear stochastic differential systems in Computers for numerous applications *Nauka* Moscow Russian Federation pp 55 - 60.
- 1308.** Pugachev V S, Sinitsyn I N, Shin V I 1987b Program realization of method of normal approximation in problems of analysis of nonlinear stochastic systems *Automatics and Tele-mechanics* no 2 pp 62 – 68.
- 1309.** Pugachev V S, Sinitsyn I N, Shin V I 1987c Problems of analysis and conditionally optimal filtering in real time scale processes in nonlinear stochastic systems (review) *Automatics and Tele-mechanics* no 12 pp 3 – 24.
- 1310.** Pugachev V S, Sinitsyn I N (editors) 1989 Principles of development of dialogue packets of applied programs for research of linear and nonlinear stochastic differential systems. Software pack “StS Analysis” version **1** *Pre-print Institute of Informatics Problems Academy of Sciences USSR* Moscow Russian Federation.
- 1311.** Pugachev V S, Sinitsyn I N 1990, 2004 Stochastic differential systems: Analysis and filtering *Nauka* Moscow Russian Federation pp 1 – 642, *Logos* Moscow Russian Federation ISBN 5-94010-199-2 pp 1 – 1000.
- 1312.** Pugachev V S, Sinitsyn I N 1999 Lectures on functional analysis and applications *World Scientific* Singapore ISBN 9810237227 ISBN 9810237235 pp 1 – 730.
- 1313.** Shannon C E 1948 A mathematical theory of communication *Bell System Technical Journal* **27** pp 379 – 423 and pp 623 – 656.
- 1314.** Bode H W, Shannon C E 1950 A simplified derivation of linear least-squares smoothing and prediction theory *Proceedings IRE* vol **38** pp 417 – 425.
- 1315.** Zadeh L A, Ragazzini J R 1950 An extension of Wiener's theory of prediction *Journal of Applied Physics* vol **21** pp 645 – 655.
- 1316.** Booton R C 1952 An optimization theory for time-varying linear systems with nonstationary statistical inputs *Proceedings IRE* vol **40** pp 977 – 981.

1317. Davis R C 1952 On the theory of prediction of nonstationary stochastic processes *Journal of Applied Physics* vol **23** pp 1047 – 1053.
1318. Bartlett M S 1954 Problemes de l'analyse spectral des series temporelles stationnaires *Publ Inst Statist University Paris III-3* pp 119 – 134.
1319. Doob J L 1955 Stochastic processes *John Wiley & Sons Inc* New York N Y USA.
1320. Franklin G 1955 The optimum synthesis of sampled-data systems *Ph D Thesis* Department of Electrical Engineering Columbia University New York USA.
1321. Laning J H, Battin R H 1956 Random processes in automatic control *McGraw-Hill Book Company Inc* New York NY, USA.
1322. Lees A B 1956 Interpolation and extrapolation of sampled data *Trans IRE Prof Group on Information Theory IT-2* 1956 pp 173 – 175.
1323. Solodovnikov V V, Batkov A M 1956 On the theory of self-optimizing systems *Proc Heidelberg Conference on Automatic Control* pp 308 – 323.
1324. Newton G C Jr, Gould L A, Kaiser J F 1957 Analytical design of linear feedback controls *John Wiley & Sons Inc* New York USA.
1325. Tukey J W 1957 On the comparative anatomy of transformations *Annals of Mathematical Statistics* **28** pp 602 – 632.
1326. Rytov S M 1957 Development of theory of nonlinear oscillations in the USSR *Radio-Technique and Electronics* no 11 pp 1435 – 1450.
1327. Cramer H 1957 Mathematical methods of statistics *Princeton University Press* Princeton NJ USA.
1328. Bellman R E, Glicksberg I, Gross O A 1958 Some aspects of the mathematical theory of control processes *RAND Report R-313* pp 1 – 244.
1329. Blum M 1958 Recursion formulas for growing memory digital filters *Trans IRE Prof Group on Information Theory IT-4* pp 24 – 30.
1330. Darlington S 1958 Linear least-squares smoothing and prediction with applications *Bell System Tech Journal* vol **37** pp 1221 – 1294.
1331. Davenport W B Jr, Root W L 1958 An introduction to the theory of random signals and noise *McGraw-Hill Book Company Inc* New York NY USA.
1332. Sherman S 1958 Non-mean-square error criteria *Trans IRE Prof Group on Information Theory IT-4* pp 125 – 126.
1333. Shinbrot M 1958 Optimization of time-varying linear systems with nonstationary inputs *Trans ASME* vol **80** pp 457 – 462.

1334. Smith O J M 1958 Feedback control systems *McGraw-Hill Book Company Inc* New York USA.
1335. Kalman R E, Koepcke R W 1958 Optimal synthesis of linear sampling control systems using generalized performance indexes *Transactions of the ASME* vol **80** pp 1820 – 1826.
1336. Kalman R E, Koepcke R W 1959 The role of digital computers in the dynamic optimization of chemical reactors *Proceedings of the Western Joint Computer Conference* pp 107 – 116.
1337. Kalman R E, Bertram J E 1958 General synthesis procedure for computer control of single and multi-loop linear systems *Transactions of the AIEE* vol **77** II pp 602 – 609.
1338. Kalman R E, Bertram J E 1959 A unified approach to the theory of sampling systems *Journal of the Franklin Institute* vol **267** pp 405 – 436.
1339. Kalman R E 1960a On the general theory of control systems *Proceedings of the First International Conference on Automatic Control* Moscow USSR.
1340. Kalman R E 1960b A new approach to linear filtering and prediction problems *Journal of Basic Engineering Transactions ASME Series D* **82** pp 35 – 45; **59** pp 1551 – 1580.
1341. Kalman R E, Bucy R S 1961 New results in linear filtering and prediction theory *Journal of Basic Engineering Transactions ASME Series D* **83** pp 95 – 108.
1342. Kalman R E 1963 New methods in Wiener filtering theory *in* Proceedings of the First Symposium of Engineering Applications of Random Function Theory and Probability Bogdanoff J L, Kozin F (editors) *John Wiley and Sons Inc* New York USA pp 270 – 388.
1343. Merriam C W III 1959 A class of optimum control systems *Journal of the Franklin Institute* vol **267** pp 267 – 281.
1344. Stratonovich R L 1959a Optimum nonlinear systems which bring about a separation of a signal with constant parameters from noise *Radiofizika* **2** (6) pp 892 – 901.
1345. Stratonovich R L 1959b On the theory of optimal non-linear filtering of random functions *Theory of Probability and its Applications* **4** pp 223 – 225.
1346. Stratonovich R L 1960a Application of the Markov processes theory to optimal filtering *Radio Engineering and Electronic Physics* **5** (11) pp 1 – 19.
1347. Stratonovich R L 1960b Conditional Markov processes *Theory of Probability and its Applications* **5** pp 156 – 178.
1348. Stratonovich R L 1961 Selected problems in theory of oscillations in radio-technique *Soviet Radio* Moscow Russian Federation.

- 1349.** Stratanovich R L 1964 New form of formulation of stochastic integrals and equations *Moscow State University Bulletin Series 1 Mathematics and Mechanics* Moscow Russian Federation.
- 1350.** Stratanovich R L 1966 Conditional Markov processes and their application in theory of optimal control *Moscow State University Publishing House* Moscow Russian Federation.
- 1351.** Volterra V 1959 Theory of functionals and integral and integro-differential equations *Dover Publications Inc* New York USA.
- 1352.** Middleton D 1960 An introduction to statistical communication theory *McGraw - Hill* New York USA.
- 1353.** US Air Forces Office of Scientific Research 1960 – 2014 Full extended complemented digital collection of technical research reports completed under US AFOSR contracts in 1960 – 2014 *US Air Forces Office of Scientific Research (US AFOSR)* Arlington DC USA.
- 1354.** Friedman M 1962 The interpolation of time series by related series *Journal of the American Statistical Association* **57** pp 729 – 757.
- 1355.** Kushner H J 1964a On the differential equations satisfied by the conditional densities of Markov processes with applications *Journal SIAM Control Ser A* vol **2** pp 106 – 119.
- 1356.** Kushner H J 1964b On the dynamical equations of conditional probability density functions with applications to optimal stochastic control theory *Journal Math Anal Appl* vol **8** pp 332 – 334.
- 1357.** Kushner H J 1967a Dynamical equations for optimal nonlinear filtering *Journal Differential Equations* vol **3** pp 179 – 190.
- 1358.** Kushner H J 1967b Approximations to optimal nonlinear filters *IEEE Transactions on Automatic Control* vol **12**.
- 1359.** Kushner H J, Budhiraja A S 2000 A nonlinear filtering algorithm based on an approximation of the conditional distribution *IEEE Transactions on Automatic Control* vol **45** no 3.
- 1360.** Busy R S 1967 Optimal filtering for correlated noise *Journal of Mathematical Analysis and Applications* vol **20** no 1 pp 1 – 8.
- 1361.** Fisher I R 1967 Optimal nonlinear filtering *in* Advances in control systems. Theory and application Leondes C T (editor) vol **5** pp 199 – 300 *Academic Press* New York London USA UK.
- 1362.** Liptser R Sh, Shiryaev A N 1968 Nonlinear filtering of diffusive Markov processes *Steklov Institute Research Works Academy of Sciences USSR* vol **104** pp 135 – 180.

- 1363.** Liptser R Sh, Shiryaev A N 1974 Statistics of random processes *Nauka* Moscow Russian Federation.
- 1364.** Bryson A E, Ho Y C 1969 Applied optimal control: Optimization, estimation, and control *Blaisdell Publishing* Waltham Massachusetts USA.
- 1365.** Jazwinski A H 1970 Stochastic processes and filtering theory *Academic Press* New York USA.
- 1366.** Sorenson H W 1970 Least-squares estimation: from Gauss to Kalman *IEEE Spectrum* vol 7 pp 63 – 68.
- 1367.** Bucy R S, Joseph P D 1970 Filtering for stochastic processes with applications to guidance *John Wiley & Sons Inc* New York USA.
- 1368.** Wright-Patterson Air Forces Base (AFB) 1970 – 2014 Full extended complemented digital collection of technical research reports and research seminars minutes *Wright-Patterson Air Forces Base (AFB)* Ohio USA.
- 1369.** Chow G C, Lin A 1971 Best linear unbiased interpolation, distribution, and extrapolation of time series by related series *Review of Economics and Statistics* **53** pp 372 – 375.
- 1370.** Chow G C, Lin A 1976 Best linear unbiased estimation of missing observations in an economic time series *Journal of the American Statistical Association* **71** pp 719 – 721.
- 1371.** Chow Y S, Teicher H 1978 Probability theory: Independence, interchangeability, Martingales *Springer-Verlag* New York USA.
- 1372.** Maybeck P S 1972 The Kalman filter—An introduction for potential users *TM-72-3 Air Force Flight Dynamics Laboratory* Wright-Patterson Air Forces Base (AFB) Ohio USA.
- 1373.** Maybeck P S 1974 Applied optimal estimation—Kalman filter design and implementation *Air Force Institute of Technology* Wright-Patterson Air Forces Base (AFB) Ohio USA.
- 1374.** Maybeck P S 1990 The Kalman filter: An introduction to concepts *Autonomous Robot Vehicles* editors I J Cox and G T Wilfong *Springer-Verlag* New York USA pp 194 – 204.
- 1375.** Willner D 1973 Observation and control of partially unknown systems *Ph D Thesis Department of Electrical Engineering Massachusetts Institute of Technology* USA.
- 1376.** Leondes C T, Pearson J O 1973 Kalman filtering of systems with parameter uncertainties: A survey *International Journal of Control* vol **17** no 4 pp 785 – 801.
- 1377.** Akaike H 1974 A New look at the statistical model identification *IEEE Transactions on Automatic Control* **AC-19** pp 716 – 723.
- 1378.** Athans M 1974 The importance of Kalman filtering methods for economics *Annals of Economic and Social Measurement* vol **3** no 1 pp 49 – 64.

- 1379.** Dempster A P, Laird N M, Rubin D B 1977 Maximum likelihood estimation from incomplete data *Journal of the Royal Statistical Society* **14** pp 1 – 38.
- 1380.** Griffiths L J 1977 A continuously adaptive filter implemented as a lattice structure *Proceedings of IEEE International Conference on Acoustics, Speech, and Signal Processing* Hartford CT USA pp 683 – 686.
- 1381.** Schwarz G 1978 Estimating the dimension of a model *Annals of Statistics* **6** pp 147 – 164.
- 1382.** Falconer D D, Ljung L 1978 Application of fast Kalman estimation to adaptive equalization *IEEE Transactions Comm* vol **COM-26** pp 1439 – 1446.
- 1383.** Anderson B D O, Moore J B 1979 Optimal filtering *Prentice-Hall* Englewood Cliffs NJ USA.
- 1384.** Bozic S M 1979 Digital and Kalman filtering *Edward Arnold* London USA.
- 1385.** Julier S J, Uhlmann J K 1997 A new extension of the Kalman filter to nonlinear systems *Proceedings of Aero-Sense: The 11th International Symposium on Aerospace/Defense Sensing, Simulation and Controls*.
- 1386.** Priestley M B 1981 Spectral Analysis and Time Series *John Wiley and Sons Inc* USA.
- 1387.** Geweke J F, Singleton K J 1981 Maximum likelihood confirmatory factor analysis of economic time series *International Economic Review* **22** p 1980.
- 1388.** Fernandez R B 1981 A methodological note on the estimation of time series *Review of Economics and Statistics* **63** pp 471 – 476.
- 1389.** Litterman R B 1983 A random walk, Markov model for the distribution of time series *Journal of Business and Economic Statistics* **1** pp 169 – 173.
- 1390.** Meinhold R J, Singpurwalla N D 1983 Understanding the Kalman filter *The American Statistician* **37** (2) pp 123 – 127.
- 1391.** Ahlbehrendt N, Kempe V 1984 Analyse stochastischer systeme *Academie-Verlag* Berlin Germany.
- 1392.** Harvey A C, Pierse R G 1984 Estimating missing observations in economic time series *Journal of the American Statistical Association* **79** pp 125 – 131.
- 1393.** Harvey A C 1987 Applications of the Kalman filter in econometrics *in* Advances in econometrics: Fifth World congress Bewley T F (editor) vol **1** *Econometric Society Monograph no 13* Cambridge University Press Cambridge UK.
- 1394.** Harvey A C 1989 Forecasting, structural time series models and the Kalman filter *Cambridge University Press* Cambridge UK.
- 1395.** Lewis F 1986 Optimal estimation *John Wiley & Sons Inc* USA.

- 1396.** Watson M W 1986 Univariate de-trending methods with stochastic trends *Journal of Monetary Economics* **18** pp 49 – 75.
- 1397.** Lanning S G 1986 Missing observations: A simultaneous approach versus interpolation by related series *Journal of Economic and Social Measurement* **14** pp 155 – 163.
- 1398.** Burridge P, Wallis K F 1988 Prediction theory for autoregressive-moving average processes *Econometric Reviews* **7** pp 65 – 69.
- 1399.** Proakis J G, Manolakis D G 1988 Introduction to digital signal processing *Macmillan* New York USA.
- 1400.** Caines P E 1988 Linear stochastic systems *Wiley Series in Probability and Mathematical Statistics John Wiley & Sons* New York USA.
- 1401.** de Jong P 1988 The likelihood for a state space model *Biometrika* **75** pp 165 – 169.
- 1402.** de Jong P 1989 Smoothing and interpolation with the state space model *Journal of the American Statistical Association* **84** pp 1085 – 1088.
- 1403.** de Jong P 1991 The diffuse Kalman filter *Annals of Statistics* **19** pp 1073 – 1083.
- 1404.** de Jong P, Chu-Chun-Lin S 1994 Fast likelihood evaluation and prediction for nonstationary state space models *Biometrika* **81** pp 133 – 142.
- 1405.** de Jong P, Penzer J 2004 The ARMA model in state space form *Statistics and Probability Letters* **70** pp 119 – 125.
- 1406.** Franklin G F, Powell J D, Workman M L 1990 Digital control of dynamic systems *2nd edition Addison-Wesley* USA.
- 1407.** Brockwell P J, Davis R A 1991 Time series: Theory and methods *Springer* Germany.
- 1408.** Jang J-S R 1991 Fuzzy modeling using generalized neural networks and Kalman filter algorithm *Proceedings of the 9th National Conference on Artificial Intelligence (AAAI-91)* pp 762 – 767.
- 1409.** Doran E 1992 Constraining Kalman filter and smoothing estimates to satisfy time varying restrictions *Review of Economics and Statistics* **74** pp 568 – 572.
- 1410.** Brown R G, Hwang P Y C 1992, 1997 Introduction to random signals and applied Kalman filtering *3rd edition John Wiley and Sons Inc* New York USA.
- 1411.** Gordon N J, Salmond D J, Smith A F M 1993 A novel approach to non-linear and non-Gaussian Bayesian state estimation *IEE-Proceedings F* **140** pp 107 – 113.
- 1412.** Tanizaki H 1993 Non-linear filters: Estimation and applications *Lecture Notes in economics and mathematical systems Springer Verlag* Germany.
- 1413.** Pinheiro M, Coimbra C 1993 Distribution and extrapolation of a time series by related series using logarithms and smoothing penalties *Economica* **12** pp 359 – 374.

- 1414.** Bar-Shalom, Xiao-Rong Li 1993 Estimation and tracking: Principles, techniques and software *Artech House* Boston USA.
- 1415.** Farhmeir L, Tutz G 1994 Multivariate statistical modeling based generalized linear models *Springer-Verlag* New-York USA.
- 1416.** Grimble M J 1994 Robust industrial control: Optimal design approach for polynomial systems *Prentice Hall* USA.
- 1417.** Bomhoff E 1994 Financial forecasting for business and economics *Dryden* London UK.
- 1418.** Lee J H, Ricker N L 1994 Extended Kalman filter based nonlinear model predictive control *Ind Eng Chem Res* vol **33** no 6 pp 1530 – 1541.
- 1419.** Ricker N L, Lee J H 1995 Nonlinear model predictive control of the Tennessee Eastman challenge process *Computers & Chemical Engineering* vol **19** no 9 pp 961 – 981.
- 1420.** Kleeman L 1995 Understanding and applying Kalman filtering *Department of Electrical and Computer Systems Engineering Monash University* Clayton Australia pp 1 – 37.
- 1421.** Venegas F, de Alba E, Ordorica M 1995 An economist's guide to the Kalman filter *Estudios Economicos* **10** (2) pp 123 – 145.
- 1422.** Golub G H, van Loan C F 1996 Matrix computations *3rd edition* *The John Hopkins University Press* USA.
- 1423.** Hayes M H 1996 Statistical digital signal processing and modeling *John Wiley and Sons Inc* USA.
- 1424.** Haykin S 1996 Adaptive filter theory *3rd edition* *Prentice-Hall Inc* Upper Saddle River New Jersey USA.
- 1425.** Haykin S (editor) 2001 Kalman filtering and neural networks *Wiley Inter-Science* USA.
- 1426.** Fuller W A 1996 Introduction to statistical time series *John Wiley & Sons Inc* USA.
- 1427.** Roncalli Th 1996 TSM - Time series and wavelets for finance *Global Design* Paris France.
- 1428.** Wells C 1996 The Kalman filter in finance *Advanced Studies in Theoretical and Applied Econometrics Kluwer Academic Publishers* vol **32** The Netherlands.
- 1429.** Hodrick R, Prescott E C 1997 Postwar U.S. business cycle: An empirical investigation, *Journal of Money, Credit and Banking* **29** (1) pp 1 – 16.
- 1430.** Krelle W 1997 How to deal with unobservable variables in economics *Discussion Paper no B 414 Bonn University* Germany.
- 1431.** Babbs S H, Nowman K B 1999 Kalman filtering of generalized Vasicek term structure models *Journal of Financial and Quantitative Analysis* vol **34** no 1.

- 1432.** Kim C J, Nelson C 1999 State-space models with regime-switching *MIT Press* Cambridge MA USA.
- 1433.** Pitt M K, Shephard N 1999 Filtering via simulation: Auxiliary particle filters *Journal of the American Statistical Association* **94** (446) pp 590 – 599.
- 1434.** Shiryaev A N 1999 Essentials of stochastic finance: Facts, models, theory Advanced Series on Statistical Science & Applied Probability vol **3** *World Scientific Publishing Co Pte Ltd* Kruzhilin N (translator) ISBN 981-02-3605-0 Singapore pp 1 – 834.
- 1435.** Wanhammar L 1999 DSP integrated circuits *Academic Press* San Diego USA ISBN: 0-12-734530-2 p 85.
- 1436.** Durbin J, Koopman, S J 2000 Time series analysis of non-Gaussian observations based on state-space models from both classical and Bayesian perspectives *Journal of Royal Statistical Society Series B* **62** pp 3 – 56.
- 1437.** Durbin J, Koopman S J 2002 A simple and efficient simulation smoother for state space time series analysis *Biometrika* **89** pp 603 – 615.
- 1438.** Durbin J, Koopman S J 2012 Time series analysis by state space methods *2nd edition* *Oxford University Press* Oxford UK.
- 1439.** Cuche N A, Hess M K 2000 Estimating monthly GDP in a general Kalman filter framework: Evidence from Switzerland *Economic & Financial Modelling Winter 2000* pp 153 – 193.
- 1440.** Doucet A, de Freitas J F G, Gordon N J 2001 Sequential Monte Carlo methods in practice *Springer-Verlag* New York USA.
- 1441.** Welch G, Bishop G 2001 An introduction to the Kalman filter *Department of Computer Science University of North Carolina at Chapel Hill* Chapel Hill USA.
- 1442.** Arulampalam S, Maskell S, Gordon N J, Clapp T 2002 A tutorial on particle filters for online nonlinear/non-Gaussian Bayesian tracking *IEEE Transaction on Signal Processing* **50** (2) pp 174 – 188.
- 1443.** Javaheri A, Lautier D, Galli A 2002 Filtering in finance *RBC Capital Markets Universit'e Paris IX Ecole Nationale Sup'erieure des Mines de Paris Ecole Nationale Sup'erieure des Mines de Paris* France [Filteringinfinance.pdf](#) pp 1 – 26.
- 1444.** Doucet A, Tadic V B 2003 Parameter estimation in general state-space models using particle methods *Annals of the Institute of Statistical Mathematics* **55** (2) pp 409 – 422.
- 1445.** Bahmani O, Brown F 2004 Kalman filter approach to estimate the demand for international reserves *Applied Economics* **36** (15) pp 1655 – 1668.

- 1446.** Broto C, Ruiz E 2004 Estimation methods for stochastic volatility models: A survey, *Journal of Economic Surveys* **18** (5) pp 613 – 637.
- 1447.** Ristic B, Arulampalam S, Gordon N J 2004 Beyond the Kalman Filter: Particle filters for tracking applications *1st edition Artech House Boston USA*.
- 1448.** Cappé O, Moulines E 2005 On the use of particle filtering for maximum likelihood parameter estimation in *European Signal Processing Conference Antalya Turkey*.
- 1449.** Ozbek L, Ozale U 2005 Employing the extended Kalman filter in measuring the output gap *Journal of Economic Dynamics and Control* **29** pp 1611 – 1622.
- 1450.** Poyiadjis G, Doucet A, Singh S S 2005a Particle methods for optimal filter derivative: application to parameter estimation in *Proceedings IEEE International Conference on Acoustics, Speech, and Signal Processing*.
- 1451.** Poyiadjis G, Doucet A, Singh S S 2005b Maximum likelihood parameter estimation in general state-space models using particle methods in *Proceedings of the American Statistical Association JSM 05*.
- 1452.** Proietti T 2006 Trend–cycle decompositions with correlated components *Econometric Reviews* **25** pp 61 – 84.
- 1453.** Litvin A, Konrad J Karl W C 2003 Probabilistic video stabilization using Kalman filtering and mosaicking *IS&T/SPIE Symposium on Electronic Imaging, Image and Video Communications and Proc.*
- 1454.** van Willigenburg L G, De Koning W L 2004 UDU factored discrete-time Lyapunov recursions solve optimal reduced-order LQG problems *European Journal of Control* **10** pp 588 – 601.
- 1455.** Voss H U, Timmer J, Kurths J 2004 Nonlinear dynamical system identification from uncertain and indirect measurements *International Journal Bifurcation and Chaos* **14** pp 1905 – 1933.
- 1456.** Cappé O, Moulines E, Rydén T 2005 Inference in hidden Markov models *Springer Series in Statistics Springer New York USA*.
- 1457.** Fernández-Villaverde J, Rubio-Ramírez J F 2005 Estimating dynamic equilibrium economies: Linear versus non-linear likelihood *Journal of Applied Econometrics* **20** 891910.
- 1458.** Fernández-Villaverde J, Rubio-Ramírez J F 2007 Estimating macroeconomic models: A likelihood approach *Review of Economic Studies* **74** pp 1059 – 1087.
- 1459.** Fernández-Villaverde J 2010 The econometrics of DSGE models *Journal of the Spanish Economic Association* **1** pp 3 – 49.

- 1460.** Frühwirth-Schnatter S 2006 Finite mixture and Markov switching models *Springer Series in Statistics Springer* New York USA.
- 1461.** Pasricha G K 2006 Kalman filter and its economic applications *MPRA Paper no 22734 Munich University Munich Germany* pp 1 – 14 <http://mpra.ub.uni-muenchen.de/22734/> .
- 1462.** Misra P, Enge P 2006 Global Positioning System signals, measurements, and performance *2nd edition* USA.
- 1463.** Gamerman D, Lopes H F 2006 Markov chain Monte Carlo. Stochastic simulation for Bayesian inference *2nd edition Chapman & Hall* London UK.
- 1464.** Pasricha G K 2006 Kalman filter and its economic applications *MPRA Paper no 22734 Munich University Munich Germany* pp 1 - 14 <http://mpra.ub.uni-muenchen.de/22734/> .
- 1465.** Rajamani M R 2007 Data-based techniques to improve state estimation in model predictive control *PhD Thesis* University of Wisconsin-Madison USA.
- 1466.** Bignasca F, Rossi E 2007 Applying the Hirose-Kamada filter to Swiss data: Output gap and exchange rate pass-through estimates *Swiss National Bank working Papers 2007 – 10* Swiss National Bank Switzerland ISSN 1660-7716 pp 1 – 27.
- 1467.** Andreasen M M 2008 Non-linear DSGE models, the central difference Kalman filter, and the mean shifted particle filter *CREATES Research Paper 2008-33* School of Economics and Management University of Aarhus Denmark pp 1 – 46.
- 1468.** Olsson J, Cappé O, Douc R, Moulines E 2008 Sequential Monte Carlo smoothing with application to parameter estimation in nonlinear state space models *Bernoulli* **14** (1) pp 155 – 179.
- 1469.** Roncalli T, Weisang G 2008 Tracking problems, hedge fund replication and alternative beta *MPRA Paper no 37358 Munich University Munich Germany* <http://mpra.ub.unimuenchen.de/37358/> .
- 1470.** Rajamani M R, Rawlings J B 2009 Estimation of the disturbance structure from data using semidefinite programming and optimal weighting *Automatica* **45** pp 142 – 148.
- 1471.** Bationo R, Hounkpodote H 2009 Estimated changes in prices of coffee and cocoa: Kalman filter, Hodrick-Prescott filter and modeling from Markov switching *MPRA Paper no 26980 Munich University Munich Germany* pp 1 – 22 <http://mpra.ub.unimuenchen.de/26980/> .
- 1472.** Chang Y, Miller J I, Park J Y 2009 Extracting a common stochastic trend: Theory with some applications *Journal of Econometrics* **15** pp 231 – 247.

- 1473.** Mapa D S, Sandoval M F B, Yap J E B 2009 Investigating the presence of regional economic growth convergence in the Philippines using Kalman filter MPRA Paper no 20681 Munich University Munich Germany <http://mpra.ub.uni-muenchen.de/20681/> .
- 1474.** Winschel W, Kratzig M 2010 Solving, estimating, and selecting nonlinear dynamic models without the curse of dimensionality *Econometrica* **39** (1) pp 3 – 33.
- 1475.** Francke M K , Koopman S J, de Vos A 2010 Likelihood functions for state space models with diffuse initial conditions *Journal of Time Series Analysis* **31** pp 407 – 414.
- 1476.** Luati A, Proietti T 2010 Hyper-spherical and elliptical stochastic cycles *Journal of Time Series Analysis* **31** pp 169 – 181.
- 1477.** Theoret R, and Racicot F - E 2010 Forecasting stochastic volatility using the Kalman filter: an application to Canadian interest rates and price-earnings ratio MPRA Paper no 35911 Munich University Munich Germany <http://mpra.ub.uni-muenchen.de/35911/> .
- 1478.** Xia Y, Tong H 2011 Feature matching in time series modeling *Statistical Science* **26** (1) pp 21 – 46.
- 1479.** Jungbacker B, Koopman S J, van der Wel M 2011 Maximum likelihood estimation for dynamic factor models with missing data *Journal of Economic Dynamics and Control* **35** (8) pp 1358 – 1368.
- 1480.** Moghaddam B A, Haleh H, Ebrahimijam S 2011 Forecasting trend and stock price with adaptive extended Kalman filter data *2011 International Conference on Economics and Finance Research IPEDR vol 4 IACSIT Press Singapore*.
- 1481.** Darvas Z, Varga B 2012 Uncovering time-varying parameters with the Kalman-filter and the flexible least squares: A Monte Carlo study *Working Paper 2012 / 4 Department of Mathematical Economics and Economic Analysis Corvinus University of Budapest Hungary* pp 1 – 19.
- 1482.** Hang Qian 2012 A flexible state space model and its applications MPRA Paper No 38455 Munich University Munich Germany pp 1 - 27 <http://mpra.ub.uni-muenchen.de/38455/> .
- 1483.** Proietti T, Luati A 2012a A maximum likelihood estimation of time series models: the Kalman filter and beyond MPRA Paper no 41981 Munich University Munich Germany pp 1 – 30 <http://mpra.ub.uni-muenchen.de/41981/> .
- 1484.** Proietti T, Luati A 2012b The generalised autocovariance function MPRA Paper no 43711 Munich University Munich Germany pp 1 – 30 <http://mpra.ub.unimuenchen.de/43711/>.
- 1485.** Creal D 2012 A survey of sequential Monte Carlo methods for economics and finance *Econometric Reviews* vol **31** 3 pp 245 – 296.

- 1486.** Matisko P, Havlena V 2012 Optimality tests and adaptive Kalman filter *Proceedings of 16th IFAC System Identification Symposium* Brussels Belgium.
- 1487.** Wikipedia 2014 Kalman filter *Wikipedia Foundation, Inc.*
- 1488.** Wolff Ch C P 1987 Forward foreign exchange rates, expected spot rates, and premia: A signal-extraction approach *Journal of Finance* **42** (2) pp 395 – 406.
- Artificial Intelligence Science:**
- 1489.** Turing A October 1950 Computing machinery and intelligence *Mind* **LIX** 236 pp 433 – 460 doi:10.1093/mind/LIX.236.433 ISSN 0026-4423.
- 1490.** Rich E 1983 Artificial intelligence *McGraw-Hill* USA ISBN 0-07-052261-8.
- 1491.** Winston P H 1984 Artificial intelligence *Addison-Wesley* Reading Massachusetts USA ISBN 0-201-08259-4.
- 1492.** Haugeland J 1985 Artificial intelligence: The very idea *MIT Press* Cambridge MA USA ISBN 0-262-08153-9.
- 1493.** Edelson E 1991 The nervous system *Chelsea House* New York USA ISBN 978-0-7910-0464-7.
- 1494.** Jang J-S R July 1991 Fuzzy modeling using generalized neural networks and Kalman filter algorithm *Proceedings of the 9th National Conference on Artificial Intelligence AAAI-91* pp 762 – 767.
- 1495.** Sun R, Bookman L (editors) 1994 Computational architectures: Integrating neural and symbolic processes *Kluwer Academic Publishers* Needham MA USA.
- 1496.** John G H, Langley P 1995 Estimating continuous distributions in Bayesian classifiers *The 11th Conference on Uncertainty in Artificial Intelligence.*
- 1497.** Dowe D L, Hajek A R 1997 A computational extension to the Turing Test *Proceedings of the 4th Conference of the Australasian Cognitive Science Society.*
- 1498.** Kohavi G J R 1997 Wrappers for feature subset selection *Artificial Intelligence* vol **97** no 1-2 pp 272 – 324.
- 1499.** Mitchell T 1997 Machine learning *McGraw Hill* USA.
- 1500.** Nilsson N 1998 Artificial intelligence: A new synthesis *Morgan Kaufmann Publishers* ISBN 978-1-55860-467-4.
- 1501.** Nilsson N 2010 The quest for artificial intelligence: A history of ideas and achievements *Cambridge University Press* New York USA ISBN 978-0-521-12293-1.
- 1502.** Poole D, Mackworth A, Goebel R 1998 Computational intelligence: A logical approach *Oxford University Press* New York USA ISBN 0-19-510270-3.

- 1503.** Calmet J, Benhamou B, Caprotti O, Henocque L, Sorge V (editors) 2002 Artificial intelligence, automated reasoning, and symbolic computation *Springer-Verlag* Berlin Germany.
- 1504.** Russell S J, Norvig P 2003 Artificial intelligence: A modern approach 2nd edition *Prentice Hall* Upper Saddle River New Jersey USA ISBN 0-13-790395-2.
- 1505.** Luger G, Stubblefield W 2004 Artificial intelligence: Structures and strategies for complex problem solving 5th edition *The Benjamin Cummings Publishing Company Inc* ISBN 0-8053-4780-1.
- 1506.** Bach J 2008 Seven principles of synthetic intelligence in Artificial general intelligence 2008 Proceedings of the First AGI Conference Wang P, Goertzel B, Franklin S (editors) *IOS Press* pp 63 – 74 ISBN 978-1-58603-833-5.
- 1507.** Neapolitan R, Jiang X 2012 Contemporary artificial intelligence *Chapman & Hall* CRC ISBN 978-1-4398-4469-4.
- Absorption Theory and Experiment in Physics, Chemistry, Electrical, Electronics and Computer Engineering Sciences:**
- 1508.** Ledenyov O P, Neklyudov I M 2013 Distribution of small dispersive coal dust particles and absorbed radioactive chemical elements in conditions of forced acoustic resonance in iodine air filter at nuclear power plant *Cornell University NY USA* [www.arxiv.org 1306.3324](http://www.arxiv.org/abs/1306.3324).pdf pp 1 – 8.
- 1509.** Neklyudov I M, Dovbnya A N, Dikiy N P, Ledenyov O P, Lyashko Yu V 2013 Features of adsorbed radioactive chemical elements and their isotopes distribution in iodine air filters AU-1500 at nuclear power plants *Cornell University NY USA* [www.arxiv.org 1307.2914](http://www.arxiv.org/abs/1307.2914).pdf pp 1 – 9.
- 1510.** Neklyudov I M, Ledenyov O P, Fedorova L I, Poltinin P Ya 2013a Generation of concentration density maxima of small dispersive coal dust particles in horizontal iodine air filter at air-dust aerosol blow *Cornell University NY USA* [www.arxiv.org 1306.2853](http://www.arxiv.org/abs/1306.2853).pdf pp 1 – 7.
- 1511.** Neklyudov I M, Ledenyov O P, Fedorova L I, Poltinin P Ya 2013b Influence by small dispersive coal dust particles of different fractional consistence on characteristics of iodine air filter at nuclear power plant *Cornell University NY USA* [www.arxiv.org 1302.4223](http://www.arxiv.org/abs/1302.4223).pdf pp 1 – 6.
- 1512.** Neklyudov I M, Fedorova L I, Poltinin P Ya, Ledenyov O P 2013 Features of coal dust dynamics at action of differently oriented forces in granular filtering medium *Cornell University NY USA* [www.arxiv.org 1301.5806](http://www.arxiv.org/abs/1301.5806).pdf pp 1 – 8.

- 1513.** Ledenyov O P, Neklyudov I M, Poltinin P Ya, Fedorova L I 2012a Physical features of accumulation and distribution processes of small disperse coal dust precipitations and absorbed radioactive chemical elements in iodine air filter at nuclear power plant *Cornell University* NY USA [www.arxiv.org 1209.3151.pdf](http://www.arxiv.org/abs/1209.3151) pp 1 – 6.
- 1514.** Ledenyov O P, Neklyudov I M, Poltinin P Ya, Fedorova L I 2012b Physical features of small disperse coal dust fraction transportation and structurization processes in iodine air filters of absorption type in ventilation systems at nuclear power plants *Cornell University* NY USA [www.arxiv.org 1208.5198.pdf](http://www.arxiv.org/abs/1208.5198) pp 1 – 9.
- 1515.** Neklyudov I M, Ledenyov O P, Fedorova L I, Poltinin P Ya 2012 On the structurization of coal dust precipitations and their influence on aerodynamic resistance by granulated mediums in air filters at nuclear power plants *Cornell University* NY USA [www.arxiv.org 1207.0456.pdf](http://www.arxiv.org/abs/1207.0456) pp 1 – 7.
- 1516.** Ledenyov O P 2012a On the structure of quantum intermediate state in type I superconductors *Cornell University* NY USA [www.arxiv.org 1204.5976v1.pdf](http://www.arxiv.org/abs/1204.5976v1) pp 1 – 5.
- 1517.** Ledenyov V O, Ledenyov D O, Ledenyov O P, Tikhonovsky M A 2012 Influence by proximity effect on ultrasound attenuation in Cu-Nb composite system at low temperatures *Cornell University* NY USA [www.arxiv.org 1204.3837v1.pdf](http://www.arxiv.org/abs/1204.3837v1) pp 1 – 6.
- 1518.** Ledenyov O P 2012b Geometric resonance in intermediate state of type I superconductors *Cornell University* NY USA [www.arxiv.org 1207.3712.pdf](http://www.arxiv.org/abs/1207.3712) pp 1 – 4.
- 1519.** Ledenyov O P 2012c Oscillatory tilt effect in a metal in a weak magnetic field *Cornell University* NY USA [www.arxiv.org 1208.0724.pdf](http://www.arxiv.org/abs/1208.0724) pp 1 – 3.
- 1520.** Ledenyov O P, Fursa V P 2012 On the parameters of intermediate state structure in high pure type I superconductors at external magnetic field *Cornell University* NY USA [www.arxiv.org 1208.0723.pdf](http://www.arxiv.org/abs/1208.0723) pp 1 – 5.
- 1521.** Shepelev A G, Ledenyov O P, Filimonov G D 2012a New effects in absorption of ultrasound in intermediate state of high pure type I superconductor *Cornell University* NY USA [www.arxiv.org 1210.1325.pdf](http://www.arxiv.org/abs/1210.1325) pp 1 – 4.
- 1522.** Shepelev A G, Ledenyov O P, Filimonov G D 2012b Anomalous attenuation of longitudinal ultrasound in intermediate state of high pure type I superconductor *Cornell University* NY USA [www.arxiv.org 1210.1655.pdf](http://www.arxiv.org/abs/1210.1655) pp 1 – 3.
- 1523.** Shepelev A G, Ledenyov O P, Filimonov G D 2012c Experimental research of longitudinal ultrasound absorption in intermediate state of high pure type I superconductor *Cornell University* NY USA [www.arxiv.org 1211.0114.pdf](http://www.arxiv.org/abs/1211.0114) pp 1 – 8.

- 1524.** Shepelev A G, Ledenyov O P, Filimonov G D 2012d Effect of anomalously high oscillations of velocity of longitudinal ultrasound in high pure type I superconductor at weak external magnetic field *Cornell University* NY USA [www.arxiv.org 1211.0394.pdf](http://www.arxiv.org/abs/1211.0394) pp 1 – 3.
- 1525.** Shepelev A G, Ledenyov O P, Filimonov G D 2012e Influence by trajectorial electron transport on anomalous ultrasound attenuation in high pure Gallium single crystal *Cornell University* NY USA [www.arxiv.org 1211.0789.pdf](http://www.arxiv.org/abs/1211.0789) pp 1 – 4.
- 1526.** Abramenkov A D, Fogel' Ya M, Slyozov V V, Tanatarov L V, Ledenyov O P 2012 Research on diffusion of Mo substrate atoms into Ti and Cr thin films by secondary ion-ion emission method *Cornell University* NY USA [www.arxiv.org 1209.4750.pdf](http://www.arxiv.org/abs/1209.4750) pp 1 – 3.
- 1527.** Ledenyov D O, Mazierska J E, Allen G, Jacob M V 2012 Lumped element modeling of nonlinear properties of high temperature superconductors in a dielectric resonator *Cornell University* NY USA [www.arxiv.org 1207.5362.pdf](http://www.arxiv.org/abs/1207.5362) pp 1 – 4.
- 1528.** Leong K, Mazierska J E, Jacob M V, Ledenyov D O, Batt S 2012 Comparing unloaded Q-factor of a high-Q dielectric resonator measured using the transmission mode and reflection mode methods involving S-parameter circle fitting *Cornell University* NY USA [www.arxiv.org 1207.5622.pdf](http://www.arxiv.org/abs/1207.5622) pp 1 – 4.
- 1529.** Mazierska J E, Ledenyov D O, Jacob M V, Krupka J 2012 Precise microwave characterization of MgO substrates for HTS circuits with superconducting post dielectric resonator *Cornell University* NY USA [1207.5906.pdf](http://www.arxiv.org/abs/1207.5906) pp 1 – 6.
- 1530.** Jacob M V, Mazierska J E, Ledenyov D O, Krupka J 2012 Microwave characterization of CaF₂ at cryogenic temperatures using a dielectric resonator technique *Journal of the European Ceramic Society* **23** pp 2617 – 2622 2003 *Cornell University* NY USA [www.arxiv.org 1209.0110.pdf](http://www.arxiv.org/abs/1209.0110) pp 1 – 6.
- 1531.** Mazierska J E, Krupka J, Jacob M V, Ledenyov D O 2012 Complex permittivity measurements at variable temperatures of low loss dielectric substrates employing split post and single post dielectric resonators *2004 IEEE MTT-S Digest* *Cornell University* NY USA [www.arxiv.org 1209.0111.pdf](http://www.arxiv.org/abs/1209.0111) pp 1 – 4.
- 1532.** Jacob M V, Mazierska J E, Leong K, Ledenyov D O, Krupka J 2012 Surface resistance measurements of HTS thin films using SLAO dielectric resonator [1209.4519.pdf](http://www.arxiv.org/abs/1209.4519) pp 1 – 4.
- 1533.** Jacob M V, Mazierska J E, Krupka J, Ledenyov D O, Takeuchi S 2012 Microwave properties of Yttrium Vanadate at cryogenic temperatures *Cornell University* NY USA [www.arxiv.org 1209.5255.pdf](http://www.arxiv.org/abs/1209.5255) pp 1 – 4.

- 1534.** Mazierska J E, Jacob M V, Ledenyov D O, Krupka J 2012 Loss tangent measurements of dielectric substrates from 15 K to 300 K with two resonators: Investigation into accuracy issues *Cornell University* NY USA [www.arxiv.org 1210.2230.pdf](http://www.arxiv.org/abs/1210.2230) pp 1 – 4.
- 1535.** Ledenyov D O 2013 Nonlinear surface resistance of $\text{YBa}_2\text{Cu}_3\text{O}_{7-\delta}$ superconducting thin films on MgO substrates in dielectric resonator at ultra high frequencies *Cornell University* NY USA [www.arxiv.org 1303.1276.pdf](http://www.arxiv.org/abs/1303.1276) pp 1 – 10.
- I.** Mazierska J E, Leong K T, Ledenyov D O, Rains A, Zuchowski N, Krupka J 2014 Microwave measurements of surface resistance and complex conductivity of NdBaCuO films *Advances in Science and Technology* vol **95** pp 162 - 168 *Trans Tech Publications* Switzerland doi:10.4028/www.scientific.net/AST.95.162
<http://www.ttp.net/> .
- Business Administration Science, Management Science, Strategy Science:**
- 1536.** Chandler A D Jr 1962, 1998 Strategy and structure: Chapters in the history of the American industrial enterprise *Beard Books* USA ISBN-10: 158798198X ISBN-13: 978-1587981982 pp 1 – 480.
- 1537.** Chandler A D Jr 1977, 1993 The visible hand: The managerial revolution in American business *Belknap Press* ISBN-10 0674940520 ISBN-13 978-0674940529 pp 1 – 624.
- 1538.** Chandler A D Jr, Daems H 1980 Managerial hierarchies: Comparative perspectives on the rise of the modern industrial enterprise *Harvard University Press* ISBN 9780674547414 .
- 1539.** Chandler A D Jr 1994 Scale and scope: The dynamics of industrial capitalism *Belknap Press* USA ISBN-10: 0674789954 ISBN-13: 978-0674789951 pp 1 – 780.
- 1540.** Chandler A D Jr 2001 Inventing the electronic century: The epic story of the consumer electronics and computer industries *Free Press* USA ISBN-10: 0743215672 ISBN-13: 978-0743215671 pp 1 – 336.
- 1541.** Chandler A D Jr 2005 Shaping the industrial century: The remarkable story of chemical and pharmaceutical industries *Harvard University Press* Cambridge Massachusetts USA ISBN 0-674-01720-X pp 1 – 366.
- 1542.** Porter M E March-April 1979 How competitive forces shape strategy *Harvard Business Review* **57** (2) pp 137 – 145.
- 1543.** Porter M E 1980, 1998 Competitive strategy: Techniques for analyzing industries and competitors *Free Press* New York USA.
- 1544.** Porter M E, Harrigan K R 1981 A framework for looking at endgame strategies in Strategic management and business policy Glueck B (editor) *McGraw-Hill* USA.
- 1545.** Porter M E 1982a Cases in competitive strategy *Free Press* New York USA.

- 1546.** Porter M E 1982b Industrial organization and the evolution of concepts for strategic planning: The new learning *in* Corporate strategy: The integration of corporation planning models and economics Taylor T H (editor) *North-Holland Publishing Company* Amsterdam The Netherlands.
- 1547.** Porter M E, Salter M S March 1982, June 1986 Note on diversification as a strategy *Harvard Business School Background Note* Harvard University pp 382 – 129.
- 1548.** Porter M E 1983 Analyzing competitors: Predicting competitor behavior and formulating offensive and defensive strategy *in* Policy, strategy, and implementation Leontiades M (editor) *Random House* USA.
- 1549.** Porter M E 1985 Defensive strategy *Strategy* **7** (1).
- 1550.** Porter M E May 1987a The state of strategic thinking *Economist* London UK.
- 1551.** Porter M E 1987b From competitive advantage to corporate strategy *Harvard Business Review* pp 43 – 59.
- 1552.** Porter M E April 1991 America's green strategy *Scientific American* **264** (4).
- 1553.** Montgomery C A, Porter M E (editors) 1991 Strategy: Seeking and securing competitive advantage *Harvard Business School Press* Boston Massachusetts USA.
- 1554.** Porter M E 1994a Global strategy: Winning in the World-wide marketplace *in* The portable MBA in strategy Fahey L, Randall R M (editors) *John Willey & Sons* NY USA.
- 1555.** Porter M E 1994b Competitive strategy revisited: A view from the 1990s *in* The relevance of a decade: Essays to mark the first ten years of the *Harvard Business School Press* Duffy P B (editor) *Harvard Business School Press* Boston Massachusetts USA.
- 1556.** Porter M E 1996a What is strategy? *Harvard Business Review* **74** (6) pp 61 – 78.
- 1557.** Porter M E December 1996b Tradeoffs, activity systems, and the theory of competitive strategy *Unpublished Work* Harvard University USA.
- 1558.** Porter M E March February 1997 New strategies for inner-city economic development *Economic Development Quarterly* **11** (1).
- 1559.** Schwab K, Connellius P, Porter M E 1999 The global competitiveness report *Oxford University Press* New York USA.
- 1560.** Porter M E, Rivkin J W January 2000, March 2001 Competition & strategy: Course structure TN *Harvard Business School Teaching Note* Harvard University pp 700 – 091.
- 1561.** Porter M E March 2001a Strategy and the Internet *Harvard Business Review* **79** (3).
- 1562.** Porter M E 2001b The technological dimension of competitive strategy *in* Research on technological innovation, management and policy vol **7** Burgelman R A, Chesbrough H (editors) *JAI Press* Greenwich CT USA.

- 1563.** Porter M E, Sakakibara M 2004 Competition in Japan *Journal of Economic Perspectives* Winter Issue.
- 1564.** Anand B N, Bradley S P, Ghemawat P, Khanna T, Montgomery C A, Porter M E, Rivkin J W, Rukstad M G, Wells J R, Yoffie D B June 2005, September 2008 Strategy: Building and sustaining competitive advantage *Harvard Business School Class Lecture* Harvard University USA pp 705 – 509.
- 1565.** Porter M E, Kramer M R December 2006 Strategy and society: The link between competitive advantage and corporate social responsibility *Harvard Business Review* **84** (12).
- 1566.** Porter M E January 2008 The five competitive forces that shape strategy *Special Issue on HBS Centennial Harvard Business Review* **86** (1).
- 1567.** Porter M December 2013 Fundamental purpose *Value Investor Insight* pp 8 – 20 www.valueinvestorinsight.com .
- 1568.** Schendel D E, Hofer Ch W 1979 Strategic management. A new view of business policy and planning *Little Brown* Boston USA p 9.
- 1569.** Huff A S, Reger R K 1987 A review of strategic process research *Journal of Management* vol **13** no 2 p 211.
- 1570.** Cohen W, Levinthal D 1990 Absorptive capacity: A new perspective on learning and innovation *Administrative Science Quarterly* **35** pp 128 – 152.
- 1571.** McKiernan P 1997 Strategy past, strategy futures *Long range planning* vol **30** no 5 p 792.
- 1572.** Martin R L (1998-1999, 2005-2006) Private communications on the electronic trading strategies in the foreign currencies exchange markets *Electronic Trade Laboratory Rotman School of Management* University of Toronto Canada.
- 1573.** Moldoveanu M, Martin R L 2001 Agency theory and the design of efficient governance mechanisms *Joint Committee on Corporate Governance Meeting* Rotman School of Management University of Toronto Canada pp 1 – 57.
- 1574.** Martin R L 2004 Strategic choice structuring: A set of good choices positions a firm for competitive advantage *Rotman School of Management* University of Toronto Canada pp 1 – 14 www.rotman.utoronto.ca/strategicChoiceStructuring.pdf .
- 1575.** Martin R L 2007 Becoming an integrative thinker *Rotman Magazine* Rotman School of Management University of Toronto Ontario Canada pp 4 – 9.
- 1576.** Martin R L 2007 Designing the thinker *Rotman Magazine* Rotman School of Management University of Toronto Ontario Canada pp 4 – 8.
- 1577.** Martin R L 2008 The Opposable mind *Harvard Business Press* Cambridge Massachusetts USA.

- 1578.** Martin R L 2009 The design of business *Harvard Business School Press* ISBN 1422177807 pp 1 – 256.
- 1579.** Lafley A G, Martin R L 2013 Playing to win: How strategy really works *Harvard Business Review Press* ISBN-10: 142218739X ISBN-13: 978-1422187395 pp 1 – 272.
- 1580.** Shiryaev A N 1999 Essentials of stochastic finance: Facts, models, theory *Advanced Series on Statistical Science & Applied Probability* vol **3** *World Scientific Publishing Co Pte Ltd* Kruzhilin N (translator) ISBN 981-02-3605-0 Singapore pp 383 – 395, 633 – 646.
- 1581.** Grant R 2001 Corporate strategy: Managing scope and strategy content in Pettigrew A, Thomas H, Whittington R (editors) *Handbook of strategy and management* *Sage* Newbury Park California USA pp 72 – 98.
- 1582.** Besanko D, Shanley M, Dranove D 2007 Economics of strategy *John Wiley & Sons Inc* USA.
- 1583.** Gavetti G, Rivkin J W 2007 On the origin of strategy: Action and cognition over time *Organization Science* vol **18** no 3 pp 420 – 439.
- 1584.** Teece D J, Winter S 2007 Dynamic capabilities: Understanding strategic change in organizations *Blackwell* Oxford UK.
- 1585.** Chamberlain G P 2010 Understanding strategy *Create Space* Charleston SC USA.